

VON DUPRIN®

33A/35A™
Series

Exit devices



Introduction

The proper selection and application of exit hardware, in addition to safety, are major concerns to all responsible manufacturers. Exit devices are a critical part of a door opening or access system and will provide safe and reliable service when properly applied and maintained. It is the policy of Von Duprin to design and manufacture exit devices to a high standard of quality and reliability in accordance with accepted U.S. domestic and international standards.

It is intended that the information included in this publication, when properly used, will provide clear and reliable guidelines to the proper general selection and application. However, the scope of the information is necessarily limited.

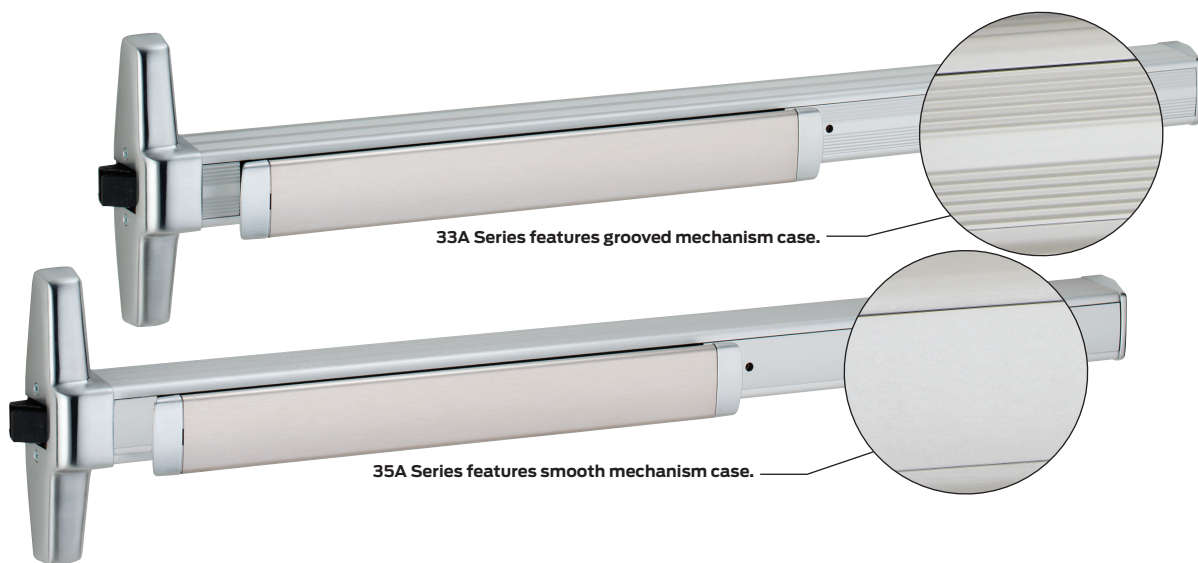

Von Duprin pushpad exit devices are available in two external surface styles, designated 33A Series and 35A Series. The two styles are mechanically and dimensionally identical and provide a wide selection of appearance options.

The Quiet One®

A fluid damper decelerates the pushpad on its return stroke and eliminates most noise associated with exit device operations. Furnished on all 33A/35A Series exit devices.

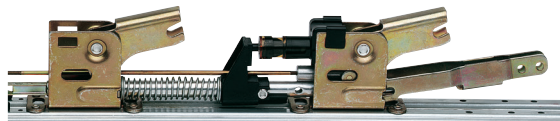

VON DUPRIN
Administrative Offices
2720 Tobey Dr.
Indianapolis, IN 46219

Customer Service
877-671-7011
800-999-0328 - Fax

Technical Support
877-671-7011

Table of contents

Exit hardware

Rim devices

33A/35A	8
Trim	9

Surface mounted Vertical rod devices

3327A/3527A	12
Trim	13

Concealed vertical rod devices

3347A/3547A	16
Trim	17
3348A/3548A	20
Trim	21
3349A/3549A	24
Trim	25
3350A/3550A	28
Trim	29

Fire exit hardware

33A-F/35A-F	10
Trim	11
3327A-F/3527A-F	14
Trim	15
3347A-F/3547A-F	18
Trim	19
3348A-F/3548A-F	22
Trim	23
3349A-F/3547A-F	26
Trim	27
3350A-F/3550A-F	30
Trim	31

Deadlocking latchbolt

Deadlocking latchbolt prevents forced latchbolt retraction providing higher security for your openings.

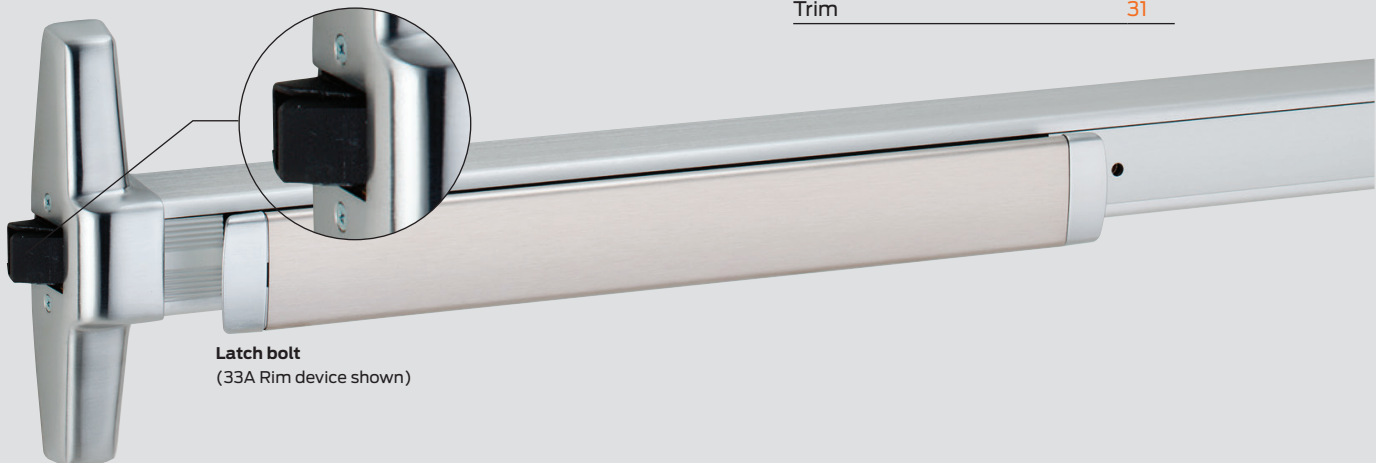

Latch bolt
(33A Rim device shown)

Options and accessories

Applications & trim operation	Trim selection Optional trim
Trim options	Optional levers Optional trim Trim selection Operation options
Strike options	Optional strikes
Additional information	ANSI Grade, type & function Device dimensions Finishes Fire label ratings/applications Handing How-to-order information Nomenclature Popular double door applications Minimum stile information

Symbols

-  Indicates fire rated application
-  Indicates ADA products

Electrical options	ALK Exit alarm kit CX Chexit delayed exit RX Request to exit WP-RX Request to exit E-Trim LX Latch bolt monitoring EL Electric latch retraction QEL Electric latch retraction SS Signal switch PN Pneumatic LBR/LBL Less bottom rod/latch PL Pullman Latch RG-27 Vertical rod and latch guard Dummy pushpad CD Cylinder dogging CDK, HDK Cylinder dogging and Hex key dogging kits GBK Glass bead kit Cylinders CON Allegion Connect
---------------------------	---

Electrical accessories	Power supplies PS902 PS914 EPT Electric power transfer
-------------------------------	---

How to order information

Rim devices, specify:

- Exit device model number with trim selection. Examples: 33A-EO (exit only with no outside trim). 33A-NL (includes 386NL trim). 33A-NL-OP (includes the 388 trim less pull).
- Size 4' (1219mm) for door sizes 2' 10" (940mm) to 4' (1219mm). Size 3' (914mm) for door sizes 2' 4" (792mm) to 3' (914mm) is shipped standard.
- Door thickness if other than 1 3/4" (44mm).
- Door and frame material if other than aluminum.
- Finish, see page 38.
- Handing required on "L", "SS", or "386NL". Specify LHR or RHR. See page 7.

Vertical rod devices, specify:

- Exit device model number with trim selection. Examples: 3327A-EO (exit only with no outside trim.) 3327A-TL-OP (includes 360T Control) 3327A-TL (includes 374T and 386DT).
- Size 2' (1219mm) for door sizes 2' (610mm). Size 3' (914mm) for door sizes 2' 2" (792mm) to 3' (914mm) is shipped standard. Size 4' (1219mm) for door sizes 2' 8" (940mm) to 4' (1219mm).
- Door thickness if other than 1 3/4" (44mm).
- Door height if greater than 7' (2134mm) surface vertical rod device (8' 4" for concealed devices) or extension rods will be supplied.
- Door and frame material if other than aluminum or hollow metal.
- Finish, see page 38.
- Handing required on "L", "SS", or "386NL". Specify LHR or RHR. See page 7.

Pullman latches are optional for 3327A/3527A and 3347A/3547A devices. Latchbolts remain extended at all times. Specify "Pullman Latch" when required.

Device trim, cross-reference*:

33/35 Devices	Status	33A/35A Devices
333NL-TP	Replaced	386NL
333DT	Replaced	386DT
337NL-TP	Replaced	386NL
337DT	Replaced	386DT
334	Replaced	388
334 x 550	Replaced	388 x 550
370L	Replaced	360L
370T	Replaced	360T
372L	Replaced	360L
374T x 333DT	Replaced	374T x 386DT
—	New	374T x 392-6
376T x 337DT	Replaced	376T x 386DT
—	New	376T x 392-6
3308NL	Obsolete	—
3308DT	Obsolete	—
—	New	388 x Ives 8190 Series Pull
—	New	360T x Ives 8190 Series Pull

*New trims not compatible with old devices, neither are old trims with new devices.

Nomenclature – how to order

		EL	33	27A	-L	-16	-F	LBR	3'	US3	RHR
CD	Cylinder dogging - panic only										
CX	Chexit delayed egress										
EL	Electric latch retraction										
HD-EL	Electric latch retraction with hex dogging										
QEL	Quiet electric latch										
HH	Hurricane										
LD	Less dogging										
LX	Latchbolt monitoring										
LX-LC	Latch bolt monitor low current										
LX-RX	Latchbolt monitor / request to exit										
LX-RX-LC	Latchbolt monitor / request to exit low current										
PL	Pullman latch										
PN	Pneumatic										
RX	Request to exit										
RX-LC	Request to exit low current										
RX2	Request to exit double switch										
SS	Signal switch										
AX	Accessible device										
WP-RX	Waterproof request to exit										
35A	Series 35A-smooth										
33A	Series 33A-grooved										
A	Rim device										
27A	Surface mounted vertical rod device										
47A	Concealed vertical rod device										
48A	Concealed vertical rod device										
49A	Concealed vertical cable device										
DT	Dummy trim										
EO	Exit only										
L	Lever (classroom)										
L-BE	Lever-blank escutcheon (passage)										
L-DT	Lever-dummy trim										
L-NL	Rigid Lever - Night latch (key retracts latchbolt)										
NL	Night latch (key retracts latchbolt)										
NL-OP	Night latch cylinder assembly – optional pull										
T	Thumbturn										
TL	Turn Lever										
T-BE	Thumbturn-blank escutcheon										
TL-BE	Turn Lever-blank escutcheon (Passage)										
XX	Lever Style 06 standard Optional 01, 02, 02KN, 03, 03KN, 05, 06KN, 07, 12 (handed), 16, 17, 17KN, 18, ACC, AST, MER, STA										
F	Fire Exit Device - Rim, 27A, 47A, 48A, 49A Only										
LBR	Less Bottom Rod										
LBL	Less Bottom Latch										
ALK	Standard Alarm Kit										
ALK-AR1	Auto-Reset 1½ minute alarm kit										
ALK-AR3	Auto-Reset 3 minute alarm kit										
ALK-AR6	Auto-Reset 4½ minute alarm kit										
CON	Allegion Connect										
2'	2' Device (2' Door Size) 27A, 47A or 49A only										
3'	3' Device (2' 4"– 3' Door Size)										
4'	4' Device (2' 10"– 4' Door size)										
Finishes	US3, US4, US10, US15 (35A only), US26, US26D, US26D-AM, US28, 313, 315										
HR	Handing – RHR or LHR										

Popular double door applications

Single door applications

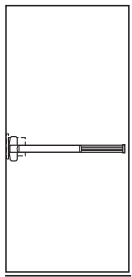

Single mortise lock device

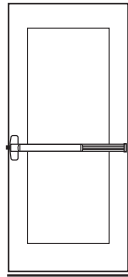

Single rim device

Double door applications

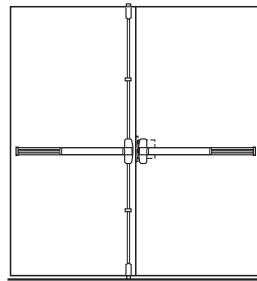

Mortise lock and surface mounted or concealed vertical cable/rod device combination—same direction

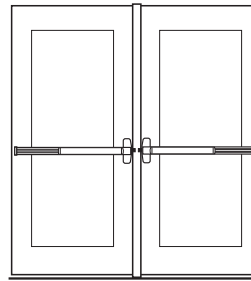

Two rim devices with mullion—same direction

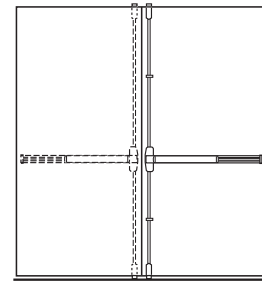

Two vertical rods—double egress

Door handing

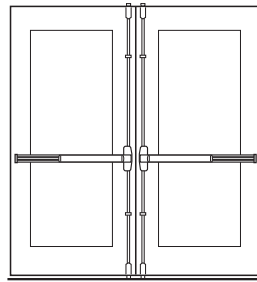
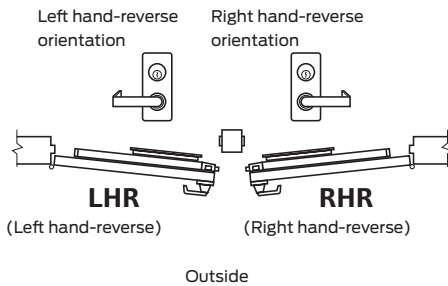

Two surface mounted vertical rod devices—same direction (do not use with overlapping astragal)

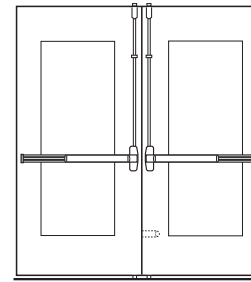

Two Fire Exit Hardware vertical cables/rods with auxiliary fire latch-LBR option

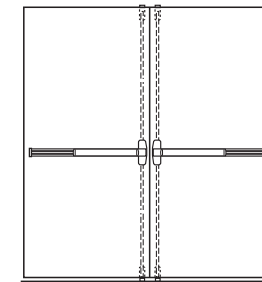

Two concealed vertical cables/rods

Trim Operation lever

Standard



Key locks and unlocks lever. e.g., 360L (Classroom)

Night latch



Key unlocks lever, lever is relocked when key is removed. Use NL suffix, e.g., 360LNL (Storeroom)

Blank escutcheon

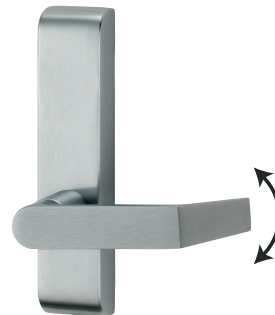

Lever always active. Use BE suffix, e.g., 360L-BE. (Passage)

Dummy



Lever is rigid for pull operation. Use DT suffix, e.g., 360L-DT.

374T/376T Series thumbturn control



Standard operation, key locks and unlocks thumbturn. Optional operation, key unlocks thumbturn, re-locks when key is removed. This operation is created by changing the cylinder plate included with control. Use 1 1/2" mortise cylinder with a straight cam. Schlage cam reference B502-191. Not available for 3349/3549 devices.

E360 Series controls

The E360 series controls provide the same choice of lever or thumbturn control of the 33A/35A Series exit device. Additionally, these trims have the advantage of being electrically controllable by a remote switching device, an access control system or automatic fire alarm system. The trim operates with a rotary solenoid that controls the locking cam the same way the standard cylinder works. These trims are available as -BE (Blank Escutcheon) function only. These trims are designed for use with the rim, surface vertical and concealed vertical 33A/35A Series exit device. No cylinder override.

Options:

- Available in all device finishes
- 24VDC Solenoid (.5 amp draw)
- Fail Safe (FS) or Fail Secure (FSE)
- Blank Escutcheon (BE) only

To order, specify:

1. FSE or FS
2. Handing - (Lever control) field reversible
3. EPT-2/EPT-10 Power Transfer or Electric Hinge will be used

Lever styles



M51
Knurling available



M52
Knurling available



M53



M54



M55



M56



M57 ..



M61
(Handed)



M62 ..
(Handed)



M63
(Handed)



M81
Knurling available



M82



M83



M84



M85
(Handed)

.. Available in Stainless Steel substrate ONLY.

Standard Levers



01



02
Knurling available



03*
Knurling available



05



06*
Default lever
Knurling available



07



12
(Handed)



16
(Omega)



17*
Knurling available



18



ACC
(Accent)
(Handed)



AST
(Asti)
(Handed)



MER
(Merano)
(Handed)



STA
(St. Annes)
(Handed)



LAT*
Latitude



LON*
Longitude

*Available in Stainless Steel - specify SS when ordering

33A/35A Rim device

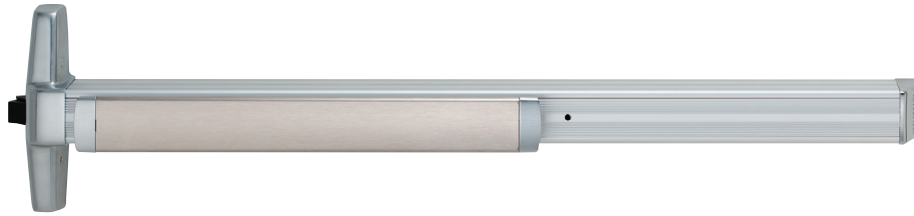

1439 Roller ships standard, optional strikes available



299 Strike needs to be specified for Hollow Metal Frames

33A and 35A for all types of single and double doors with mullion, UL listed for panic exit hardware. Devices are ANSI A156.3 – 2014 Grade 1. The 35A has a smooth mechanism case and the 33A has grooved case. The rim device is non-handed except when the SS (signal switch) option is used. See opposite page for available outside trim and device functions.

33A/35A fits door stiles as narrow as 1 3/4" (44mm). Newly designed device has a one piece center case cover.

Finishes – US3, US4, US10, US15 (35A Only) US26, US26D, US26D-AM, US28, 313 and 315.

Specifications

Device lengths	3' 2' 4" to 3' (711mm to 914 mm) Door size 4' 2'10" to 4' (864 mm to 1219 mm) Door size
Device centerline from finished floor	39 13/16" (1011 mm) 39 11/16" (1008 mm) with Mullion
Center case dimensions	8 3/16" x 1 9/16" x 2 13/32" (208mm x 40mm x 62mm)
Mechanism case dimensions	2 1/4" x 2 1/4" (57mm x 57mm)
Projection	Pushbar Neutral – 3 13/16" (97 mm) Pushbar Depressed – 3 1/16" (78 mm)
Latch bolt	Deadlocking, 3/4" (19mm) throw
Fasteners & sex bolts (SNB)	Includes 1 3/4" (44mm) – 2 1/4" (57mm) wood & metal doors #425 SNB furnished standard for end case #325 SNB furnished standard for EO (exit only device)
Electric options	ALK Alarm kit CX Chexit delayed exit EL Electric latch retraction HD-EL Electric latch retraction with hex dogging QEL Quiet electric latch retraction RX Request to exit, WP-RX waterproof option LX Latchbolt monitoring LX-RX Request to exit / latchbolt monitoring RX-LC, LX-LC, LX-RX-LC Low current option for RX, LX, LX-RX SS Signal switch CON Allegion Connect
Mechanical options	AX Accessible device
Miscellaneous options	GBK Glass bead kit PN Pneumatic SG Safety glow SEC Security screws SNB Sex bolts
Dogging feature	Hex Dogging standard CD Cylinder dogging LD Less dogging
Strikes	1439 – Dull black Optional strikes

QEL
Quiet electric latch retraction

- Bolt retraction via switch
- Converts exit door to push-pull operation

AX
Accessible device

- UL certified to meet new 5 lb. maximum operating force requirement
- Exceeds ANSI/BHMA requirements

CX
Chexit delayed exit

- Meets NFPA 101 requirements
- Self-contained controls, locking, alarm

ALK
Alarm exit kit

- Unauthorized opening triggers 85-decibel horn
- Set in armed or disarmed mode by key

EL
Electric latch retraction

- Enables remote unlatching
- Alternative to manual dogging

RX
Pushpad monitor switch

- Signals use of an opening
- SPDT switch to monitor pushpad

E (E360L)
Electric lever trim

- Electrified remote locking/unlocking
- Fail safe & fail secure options available
- No key override

CON
Allegion Connectors

- Common connectors to connect various door hardware all the way to the power supply





PN
Pneumatic latch retraction





- For areas where electrical devices banned
- Special linkage for mechanical or pneumatic dogging

CD
Cylinder dogging

- Replaces hex key dogging
- Requires standard 1 1/4" mortise cylinder

Standard trim

	EO	DT	NL	NL-OP
				
Product description	33A-EO 35A-EO	33A-DT 35A-DT	33A-NL 35A-NL	33A-NL-OP 35A-NL-OP
Trim description	—	386DT	386NL	388
Base size	—	7 ¹⁵ / ₃₂ " x 1 ⁵ / ₈ " (190x41mm)	7 ¹⁵ / ₃₂ " x 1 ⁵ / ₈ " (190x41mm)	7 ¹ / ₂ " x 1 ¹¹ / ₁₆ " (190x43mm)
Grip size	—	8 ¹ / ₂ " x 4 ⁹ / ₁₆ " (216x110mm)	8 ¹ / ₂ " x 4 ⁵ / ₁₆ " (216x110mm)	—
Projection	—	2 ⁷ / ₁₆ " (62mm)	2 ⁷ / ₁₆ " (62mm)	1" (25mm)
ANSI function	01	02	03	03
Cylinder type	—	—	Rim	Rim
Handing	—	—	Handed	—
Optional trim	—	x360L-DT x550DT x IVES 8190	—	x550DT x IVES 8190 10"

	L	L-BE	T	T-BE
				
Product description	33A-L 35A-L	33A-L-BE 35A-L-BE	33A-T 35A-T	33A-T-BE 35A-T-BE
Trim description	360L	360L-BE	360T	360T-BE
Base size	7 ¹ / ₂ " x 1 ¹¹ / ₁₆ " x 7 ⁷ / ₈ " (190x43x22mm)	7 ¹ / ₂ " x 1 ¹¹ / ₁₆ " x 7 ⁷ / ₈ " (190x43x22mm)	7 ¹ / ₂ " x 1 ¹¹ / ₁₆ " x 7 ⁷ / ₈ " (190x43x22mm)	7 ¹ / ₂ " x 1 ¹¹ / ₁₆ " x 7 ⁷ / ₈ " (190x43x22mm)
Grip size	—	—	—	—
Projection	3" (76mm)	3" (76mm)	1 ¹³ / ₁₆ " (46mm)	1 ¹³ / ₁₆ " (46mm)
ANSI function	08 or 09 field selectable	—	11 or 12 field selectable	—
Cylinder type	1 ¹ / ₄ " Mortise	—	1 ¹ / ₄ " Mortise	—
Handing	Handed/Reversible	Handed/Reversible	—	—
Optional trim	—	E360L-BE	—	E360T-BE

Note: 360L & 360T used on wood door require the 33A-WDA cover plate

Notes

33A-F/35A-F Rim fire exit device

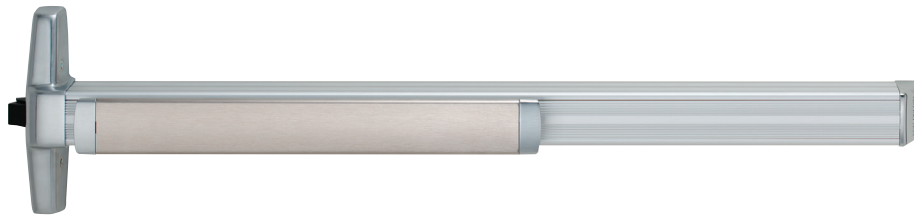

33A-F and 35A-F for all types of single and double fire rated doors with mullion, UL listed for Fire Exit Hardware. See page 47 for detailed information on UL listed fire exit hardware label and door opening size information. Devices are ANSI A156.3 – 2014 Grade 1. The 35A has a smooth mechanism case and the 33A has grooved case. The rim device is non-handed except when the SS (signal switch) option is used. See opposite page for available outside trim and device functions.

33A/35A fits door stiles as narrow as 1 3/4" (44mm).

Finishes – US3, US4, US10, US15 (35A Only) US26, US26D, US26D-AM, US28, 313 and 315.



Specifications

Device lengths	3' 2' 4" to 3' (711mm to 914 mm) Door size 4' 2'10" to 4' (864 mm to 1219 mm) Door size
Device centerline from finished floor	39 13/16" (1011 mm) 39 11/16" (1008 mm) with Mullion
Center case dimensions	8 3/16" x 1 9/16" x 2 13/32" (208mm x 40mm x 62mm)
Mechanism case dimensions	2 1/4" x 2 1/4" (57mm x 57mm)
Projection	Pushbar Neutral – 3 13/16" (97 mm) Pushbar Depressed – 3 1/16" (78 mm)
Latch bolt	Deadlocking, 3/4" (19mm) throw
Fasteners & sex bolts (SNB)	Includes 1 3/4" (44mm) – 2 1/4" (57mm) wood & metal doors #425 SNB furnished standard for end case #325 SNB furnished standard for EO (exit only device)
Electric options	ALK Alarm kit CX Chexit delayed exit EL Electric latch retraction QEL Quiet electric latch retraction RX Request to exit, WP-RX waterproof option LX Latchbolt monitoring LX-RX Request to exit / latchbolt monitoring RX-LC, LX-LC, LX-RX-LC Low current option for RX, LX, LX-RX SS Signal switch CON Allegion Connect
Mechanical options	AX Accessible device
Miscellaneous options	GBK Glass bead kit PN Pneumatic SG Safety glow SEC Security screws SNB Sex bolts
Strikes	299F – Dull black, 499F with mullions

QEL
Quiet electric latch retraction

- Bolt retraction via switch
- Converts exit door to push-pull operation

AX
Accessible device

- UL certified to meet new 5 lb. maximum operating force requirement
- Exceeds ANSI/BHMA requirements

CX
Chexit delayed exit

- Meets NFPA 101 requirements
- Self-contained controls, locking, alarm

ALK
Alarm exit kit

- Unauthorized opening triggers 85-decibel horn
- Set in armed or disarmed mode by key

EL
Electric latch retraction

- Enables remote unlatching
- Alternative to manual dogging

RX
Pushpad monitor switch

- Signals use of an opening
- SPDT switch to monitor pushpad



E (E360L)
Electric lever trim





- Electrified remote locking/unlocking
- Fail safe & fail secure options available
- No key override

CON
Allegion Connectors

- Common connectors to connect various door hardware all the way to the power supply

Standard trim

	EO	NL	NL-OP
			
Product description	33A-EO-F 35A-EO-F	33A-NL-F 35A-NL-F	33A-NL-OP-F 35A-NL-OP-F
Trim description	—	386NL	388
Base size	—	7 ¹⁵ / ₃₂ " x 1 ⁵ / ₈ " (190x41mm)	7 ¹ / ₂ " x 1 ¹¹ / ₁₆ " (190x43mm)
Grip size	—	8 ¹ / ₂ " x 4 ⁵ / ₁₆ " (216x110mm)	—
Projection	—	2 ⁷ / ₁₆ " (62mm)	1" (25mm)
ANSI function	01	03	03
Cylinder type	—	Rim	Rim
Handing	—	Handed	—
Optional trim	—	—	x550DT x IVES 8190 10"

	L	L-BE	T	T-BE
				
Product description	33A-L-F 35A-L-F	33A-L-BE-F 35A-L-BE-F	33A-T-F 35A-T-F	33A-T-BE-F 35A-T-BE-F
Trim description	360L	360L-BE	360T	360T-BE
Base size	7 ¹ / ₂ " x 1 ¹¹ / ₁₆ " x 7 ⁷ / ₈ " (190x43x22mm)	7 ¹ / ₂ " x 1 ¹¹ / ₁₆ " x 7 ⁷ / ₈ " (190x43x22mm)	7 ¹ / ₂ " x 1 ¹¹ / ₁₆ " x 7 ⁷ / ₈ " (190x43x22mm)	7 ¹ / ₂ " x 1 ¹¹ / ₁₆ " x 7 ⁷ / ₈ " (190x43x22mm)
Grip size	—	—	—	—
Projection	3" (76mm)	3" (76mm)	1 ¹³ / ₁₆ " (46mm)	1 ¹³ / ₁₆ " (46mm)
ANSI function	08 or 09 field selectable	—	11 or 12 field selectable	—
Cylinder type	1 ¹ / ₄ " Mortise	—	1 ¹ / ₄ " Mortise	—
Handing	Handed/Reversible	Handed/Reversible	—	—
Optional trim	—	E360L-BE	—	E360T-BE

Note: 360L & 360T used on wood door require the 33A-WDA cover plate

Notes

3327A/3527A Surface mounted vertical rod device

3327A/3527A Surface mounted vertical rod device



3327A and 3527A for all types of single and double doors, UL listed for panic exit hardware. Devices are ANSI A156.3 – 2008 Grade 1. The 3527A has a smooth mechanism case and the 3327A has grooved case. The surface vertical rod device is non-handed except when the SS (signal switch) option is used. See opposite page for available outside trim and device functions.

3327A/3527A fits door stiles as narrow as 1 3/4" (44mm). Newly designed device has a one piece center case cover.

Finishes – US3, US4, US10, US15 (35A Only) US26, US26D, US26D-AM, US28, 313 and 315.



Specifications

Device lengths	2' 2' (610 mm) Door size 3' 2'4" to 3' (660mm to 914 mm) door size 4' 2'8" to 4' (813 mm to 1219 mm) door size
Device centerline from finished floor	39 13/16" (1006mm)
Center case dimensions	8 13/16" x 2 13/32" x 1 9/16" (208mm x 62mm x 40mm)
Mechanism case dimensions	2 1/4" x 2 1/4" (57mm x 57mm)
Projection	Pushbar neutral – 3 13/16" (97 mm) Pushbar depressed – 3 1/16" (78 mm)
Latch bolt	Deadlocking anti-friction top & bottom bolt 5/8" (16mm) throw
Door undercut	1/4" (7mm)
Top & bottom latch	4 1/2" x 2 1/8" x 1 1/2" (114mm x 54mm x 38mm)
Vertical rods	1/2" square tubing, standard rods accommodate 7' (2134mm) door Top rod length is 34 15/16" (887mm) Bottom rod length is 31 1/4" (794mm) Extension rods available 1' (205mm) or 3' (914mm) for doors over 7' One piece top rod available for 8' (2438mm) -10' (3048mm) door
Fasteners & sex bolts (SNB)	Includes 1 3/4" (44mm) – 2 1/4" (57mm) wood & metal doors #425 SNB furnished standard for end case #325 SNB furnished standard for EO (exit only device) #325 SNB furnished for top and bottom latches
Electric options	ALK Alarm kit CX Chexit delayed exit EL Electric latch retraction HD-EL Electric latch retraction with hex dogging QEL Quiet electric latch retraction RX Request to exit, WP-RX waterproof option LX Latchbolt monitoring LX-RX Request to exit / latchbolt monitoring RX-LC, LX-LC, LX-RX-LC Low current option for RX, LX, LX-RX SS Signal switch CON Allegion Connect
Miscellaneous options	GBK Glass bead kit PL Pullman latch PN Pneumatic LBR Less bottom rod SG Safety glow SEC Security screws SNB Sex bolts
Dogging feature	Hex dogging standard CD Cylinder dogging LD Less dogging
Strikes	Top – 266 – Dull black, bottom – 248L4 & 304L – Unfinished Optional strikes

QEL
Quiet electric latch retraction

- Bolt retraction via switch
- Converts exit door to push-pull operation

RX
Pushpad monitor switch

- Signals use of an opening
- SPDT switch to monitor pushpad

E (E360L)
Electric lever trim

- Electrified remote locking/unlocking
- Fail safe & fail secure options available
- No key override

ALK
Alarm exit kit

- Unauthorized opening triggers 85-decibel horn
- Set in armed or disarmed mode by key

DI
Dogging Indicator

- Monitor dogging status without a control panel
- Red indicator light shows visibility to dogging from over 75 feet

CON
Allegion Connectors

- Common connectors to connect various door hardware all the way to the power supply

EL
Electric latch retraction

- Enables remote unlatching
- Alternative to manual dogging





PN
Pneumatic latch retraction





- For areas where electrical devices banned
- Special linkage for mechanical or pneumatic dogging

CD
Cylinder dogging

- Replaces hex key dogging
- Requires standard 1 1/4" mortise cylinder

Standard trim

	EO	DT	NL	NL-OP	TL
					
	Exit only no outside trim	Dummy trim pull when dogged	Night latch key retracts latchbolt	Night latch key retracts latchbolt optional pull required	Thumbturn key locks & unlocks
Product description	3327A-EO 3527A-EO	3327A-DT 3527A-DT	3327A-NL 3527A-NL	3327A-NL-OP 3527A-NL-OP	3327A-TL 3527A-TL
Trim description	—	386DT	386NL	388	374T x 386
Base size	—	7 ¹⁵ / ₃₂ " x 1 ⁵ / ₈ " (190x41mm)	7 ¹⁵ / ₃₂ " x 1 ⁵ / ₈ " (190x41mm)	7 ¹⁵ / ₃₂ " x 1 ⁵ / ₈ " (190x41mm)	7 ¹ / ₂ " x 1 ¹¹ / ₁₆ " x 7 ⁷ / ₈ " (190x43mmx22mm)
Grip size	—	8 ¹ / ₂ " x 4 ⁵ / ₁₆ " (216x110mm)	8 ¹ / ₂ " x 4 ⁵ / ₁₆ " (216x110mm)	—	—
Projection	—	2 ⁷ / ₁₆ " (62mm)	2 ⁷ / ₁₆ " (62mm)	1" (25mm)	1 ³ / ₁₆ " (46mm)
ANSI function	01	02	03	03	11-12 field selectable
Cylinder type	—	—	Rim	Rim	1 ¹ / ₄ " Mortise
Handing	—	—	Handed	—	—
Optional trim	—	x 360L-DT x 550DT x IVES 8190	—	x 550DT x IVES 8190 10"	x 392-6

	TL-BE	L	L-BE	T	T-BE
					
	Thumbturn-blank escutcheon always operable (no cylinder)	Lever key locks and unlocks	Lever blank escutcheon always operable (no cylinder)	Thumbturn key locks and unlocks	Thumbturn always operable (no cylinder)
Product description	3327A-TL-BE 3527A-TL-BE	3327A-L 3527A-L	3327A-L-BE 3527A-L-BE	3327A-T 3527A-T	3327A-T-BE 3527A-T-BE
Trim description	374T-BE x 386	360L	360L-BE	360T	360T-BE
Base size	7 ¹ / ₂ " x 1 ¹¹ / ₁₆ " x 7 ⁷ / ₈ " (190x43x22mm)	7 ¹ / ₂ " x 1 ¹¹ / ₁₆ " x 7 ⁷ / ₈ " (190x43x22mm)	7 ¹ / ₂ " x 1 ¹¹ / ₁₆ " x 7 ⁷ / ₈ " (190x43x22mm)	7 ¹ / ₂ " x 1 ¹¹ / ₁₆ " x 7 ⁷ / ₈ " (190x43x22mm)	7 ¹ / ₂ " x 1 ¹¹ / ₁₆ " x 7 ⁷ / ₈ " (190x43x22mm)
Grip size	8 ¹ / ₂ " x 4 ⁵ / ₁₆ " (216x110mm)	—	—	—	—
Projection	1 ³ / ₁₆ " (46mm)	3" (76mm)	3" (76mm)	1 ³ / ₁₆ " (46mm)	1 ³ / ₁₆ " (46mm)
ANSI function	—	08 or 09 field selectable	—	11 or 12 field selectable	—
Cylinder type	—	1 ¹ / ₄ " Mortise	—	1 ¹ / ₄ " Mortise	—
Handing	—	Handed/Reversible	Handed/Reversible	—	—
Optional Trim	x 392-6	—	E360L-BE	—	E360T-BE

Note: 360L & 360T used on wood door require the 33A-WDA cover plate 374T used on wood door require #10-WDA cover plate

Notes

3327A-F/3527A-F Surface mounted vertical rod fire exit device



3327A-F and 3527A-F for all types of double doors up to 8' x 10' (2438mm x 2540mm), UL listed for Fire Exit Hardware. See page 47 for detailed information on UL listed fire exit hardware label and door opening size information. Devices are ANSI A156.3 – 2008 Grade 1. The 3527A-F has a smooth mechanism case and the 3327A-F has grooved case. The surface vertical rod device is non-handed except when the SS (Signal Switch) option is used. See opposite page for available outside trim and device functions.

3327A-F/3527A-F fits door stiles as narrow as 2³/₁₆" (56 mm). Newly designed device has a one piece center case cover.

Finishes – US3, US4, US10, US15 (35A Only) US26, US26D, US26D-AM, US28, 313 and 315.

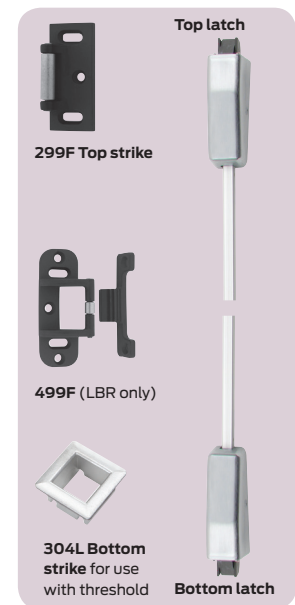

Specifications

Device lengths	2' 2" (610 mm) Door size 3' 2 1/4" to 3' (660mm to 914 mm) door size 4' 2'8" to 4' (813 mm to 1219 mm) door size
Device centerline from finished floor	39 ¹³ / ₁₆ " (1006mm)
Center case dimensions	8 ¹³ / ₁₆ " x 2 ¹³ / ₃₂ " x 1 ⁹ / ₁₆ " (208mm x 62mm x 40mm)
Mechanism case dimensions	2 ¹ / ₄ " x 2 ¹ / ₄ " (57mm x 57mm)
Projection	Pushbar neutral – 3 ¹³ / ₁₆ " (97 mm) Pushbar depressed – 3 ¹ / ₁₆ " (78 mm)
Latch bolt	Deadlocking anti-friction top & bottom bolt 5/8" (16mm) throw
Door undercut	1/4" (7mm)
Top & bottom latch	4 1/2" x 2 1/8" x 1 1/2" (114mm x 54mm x 38mm)
Vertical rods	1/2" square tubing, standard rods accommodate 7' (2134mm) door Top rod length is 34 ¹⁵ / ₁₆ " (887mm) Bottom rod length is 31 1/4" (794mm) Extension rods available 1' (205mm) or 3' (914mm) for doors over 7' One piece top rod available for 8' (2438mm) -10' (3048mm) door
Fasteners & sex bolts (SNB)	Includes 1 3/4" (44mm) – 2 1/4" (57mm) wood & metal doors #425 SNB furnished standard for end case #325 SNB furnished standard for EO (exit only device) #325 SNB furnished for top and bottom latches
Electric options	ALK Alarm kit CX Chexit delayed exit EL Electric latch retraction HD-EL Electric latch retraction with hex dogging QEL Quiet electric latch retraction RX Request to exit, WP-RX waterproof option LX Latchbolt monitoring LX-RX Request to exit / latchbolt monitoring RX-LC, LX-LC, LX-RX-LC Low current option for RX, LX, LX-RX SS Signal switch CON Allegion Connect
Miscellaneous options	GBK Glass bead kit PN Pneumatic LBR Less bottom rod SG Safety glow SEC Security screws SNB Sex bolts
Strikes	Top – 266 – Dull black, bottom – 248L4 & 304L – Unfinished Optional strikes

QEL

Quiet electric latch retraction

- Bolt retraction via switch
- Converts exit door to push-pull operation

RX

Pushpad monitor switch

- Signals use of an opening
- SPDT switch to monitor pushpad

E (E360L)

Electric lever trim

- Electrified remote locking/unlocking
- Fail safe & fail secure options available
- No key override

ALK

Alarm exit kit

- Unauthorized opening triggers 85-decibel horn
- Set in armed or disarmed mode by key

EL

Electric latch retraction

- Enables remote unlatching
- Alternative to manual dogging

CON

Allegion Connectors





- Common connectors to connect various door hardware all the way to the power supply





PN

Pneumatic latch retraction

- For areas where electrical devices banned
- Special linkage for mechanical or pneumatic dogging

Standard trim

	EO	DT	NL	NL-OP	TL
					
	Exit only no outside trim	Dummy trim pull when dogged (not recommended for fire device)	Night latch key retracts latchbolt	Night latch key retracts latchbolt optional pull required	Thumbturn key locks & unlocks
Product description	3327A-EO-F 3527A-EO-F	3327A-DT-F 3527A-DT-F	3327A-NL-F 3527A-NL-F	3327A-NL-OP-F 3527A-NL-OP-F	3327A-TL-F 3527A-TL-F
Trim description	—	386DT	386NL	388	374T x 386
Base size	—	7 ¹⁵ / ₃₂ " x 1 ⁵ / ₈ " (190x41mm)	7 ¹⁵ / ₃₂ " x 1 ⁵ / ₈ " (190x41mm)	7 ¹⁵ / ₃₂ " x 1 ¹¹ / ₁₆ " (190x43mm)	7 ¹ / ₂ " x 1 ¹¹ / ₁₆ " x 7 ⁷ / ₈ " (190x43mmx22mm)
Grip size	—	8 ¹ / ₂ " x 4 ⁵ / ₁₆ " (216x110mm)	8 ¹ / ₂ " x 4 ⁵ / ₁₆ " (216x110mm)	—	8 ¹ / ₂ " x 4 ⁵ / ₁₆ " (216x110mm)
Projection	—	2 ⁷ / ₁₆ " (62mm)	2 ⁷ / ₁₆ " (62mm)	1" (25mm)	1 ³ / ₁₆ " (46mm)
ANSI function	01	02	03	03	11-12 field selectable
Cylinder type	—	—	Rim	Rim	1 ¹ / ₄ " Mortise
Handing	—	—	Handed	—	—
Optional trim	—	x 360L-DT x 550DT x IVES 8190	—	x 550DT x IVES 8190 10"	x 392-6

	TL-BE	L	L-BE	T	T-BE
					
	Thumbturn-blank escutcheon always operable (no cylinder)	Lever key locks and unlocks	Lever blank escutcheon always operable (no cylinder)	Thumbturn key locks and unlocks (behind C/Case)	Thumbturn always operable (no cylinder) (behind C/Case)
Product description	3327A-TL-BE-F 3527A-TL-BE-F	3327A-L-F 3527A-L-F	3327A-L-BE-F 3527A-L-BE-F	3327A-T-F 3527A-T-F	3327A-T-BE-F 3527A-T-BE-F
Trim description	374T-BE x 386	360L	360L-BE	360T	360T-BE
Base size	7 ¹ / ₂ " x 1 ¹¹ / ₁₆ " x 7 ⁷ / ₈ " (190x43x22mm)	7 ¹ / ₂ " x 1 ¹¹ / ₁₆ " x 7 ⁷ / ₈ " (190x43x22mm)	7 ¹ / ₂ " x 1 ¹¹ / ₁₆ " x 7 ⁷ / ₈ " (190x43x22mm)	7 ¹ / ₂ " x 1 ¹¹ / ₁₆ " x 7 ⁷ / ₈ " (190x43x22mm)	7 ¹ / ₂ " x 1 ¹¹ / ₁₆ " x 7 ⁷ / ₈ " (190x43x22mm)
Grip size	8 ¹ / ₂ " x 4 ⁵ / ₁₆ " (216x110mm)	—	—	—	—
Projection	2 ⁷ / ₁₆ " (62mm)	3" (76mm)	3" (76mm)	1 ³ / ₁₆ " (46mm)	1 ³ / ₁₆ " (46mm)
ANSI function	—	08 or 09 field selectable	—	11 or 12 field selectable	—
Cylinder type	—	1 ¹ / ₄ " Mortise	—	1 ¹ / ₄ " Mortise	—
Handing	—	Handed/Reversible	Handed/Reversible	—	—
Optional Trim	x 392-6	—	E360L-BE	—	E360T-BE

Note: 360L & 360T used on Wood Door require the 33A-WDA cover plate 374T used on Wood Door require #10-WDA cover plate

Notes

3347A/3547A Concealed vertical rod device



3347A and 3547A for all types of single and double doors, UL listed for panic exit hardware. Devices are ANSI A156.3 – 2008 Grade 1. The 3547A has a smooth mechanism case and the 3347A has grooved case. The concealed vertical rod device is non-handed except when the SS (signal switch) option is used. See opposite page for available outside trim and device functions.

3347A/3547A fits door stiles as narrow as 2-1/8" (44 mm), wood door stiles as narrow as 4" (102mm). Newly designed device has a one piece center case cover.

Finishes – US3, US4, US10, US15 (35A Only) US26, US26D, US26D-AM, US28, 313 and 315.



Specifications

Device lengths	2' 2' (610 mm) Door size 3' 2'4" to 3' (660mm to 914 mm) door size 4' 2'8" to 4' (813 mm to 1219 mm) door size
Device centerline from finished floor	39 ¹³ / ₁₆ " (1006mm)
Center case dimensions	8 ¹³ / ₁₆ " x 2 ¹³ / ₃₂ " x 1 ⁹ / ₁₆ " (208mm x 62mm x 40mm)
Mechanism case dimensions	2 ¹ / ₄ " x 2 ¹ / ₄ " (57mm x 57mm)
Projection	Pushbar neutral – 3 ³ / ₁₆ " (97 mm) Pushbar depressed – 3 ¹ / ₁₆ " (78 mm)
Latch bolt	Deadlocking anti-friction top & bottom bolt ⁵ / ₈ " (16mm) throw
Door undercut	¹ / ₄ " (7mm)
Top & bottom latch	3 ³ / ₄ " x 1 ¹ / ₂ " x 1" (89mm x 38mm x 25mm)
Vertical rods	Round 2 piece adjustable rods Top rod adjustable from 6'8" (2027mm) to 8'4" (2533mm) Bottom rod adjustable from 35 ⁵ / ₈ " (905mm) to 49 ⁵ / ₈ " (1260mm) Extension rod kits available for doors over 8'4" (2533mm)
Fasteners & sex bolts (SNB)	Includes 1 ³ / ₄ " (44mm) – 2 ¹ / ₄ " (57mm) wood & metal doors #425 SNB furnished standard for end case #325 SNB furnished standard for EO (exit only device)
Electric options	ALK Alarm kit CX Chexit delayed exit EL Electric latch retraction HD-EL Electric latch retraction with hex dogging QEL Quiet electric latch retraction RX Request to exit, WP-RX waterproof option LX Latchbolt monitoring LX-RX Request to exit / latchbolt monitoring RX-LC, LX-LC, LX-RX-LC Low current option for RX, LX, LX-RX SS Signal switch CON Allegion Connect
Miscellaneous options	GBK Glass bead kit PL Pullman latch PN Pneumatic HH Hurricane INS-2/INS-4 Insulclad kits 1/2" / 1/4" panels LBR Less bottom rod SG Safety glow SEC Security screws SNB Sex bolts
Dogging feature	Hex dogging standard CD Cylinder dogging LD Less dogging
Strikes	Top – 388 – Unfinished, bottom – 385A – Unfinished Optional strikes

QEL
Quiet electric latch retraction

- Bolt retraction via switch
- Converts exit door to push-pull operation

RX
Pushpad monitor switch

- Signals use of an opening
- SPDT switch to monitor pushpad

E (E360L)
Electric lever trim

- Electrified remote locking/unlocking
- Fail safe & fail secure options available
- No key override

ALK
Alarm exit kit

- Unauthorized opening triggers 85-decibel horn
- Set in armed or disarmed mode by key

EL
Electric latch retraction

- Enables remote unlatching
- Alternative to manual dogging

CON
Allegion Connectors

- Common connectors to connect various door hardware all the way to the power supply

DI
Dogging Indicator

- Monitor dogging status without a control panel
- Red indicator light shows visibility to dogging from over 75 feet





PN
Pneumatic latch retraction





- For areas where electrical devices banned
- Special linkage for mechanical or pneumatic dogging

CD
Cylinder dogging

- Replaces hex key dogging
- Requires standard 1¹/₄" mortise cylinder

Standard trim

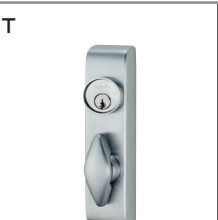
	EO	DT	NL	NL-OP	TL
					
	Exit only no outside trim	Dummy trim pull when dogged	Night latch key retracts latchbolt	Night latch key retracts latchbolt optional pull required	Thumbturn key locks & unlocks
Product description	3347A-EO 3547A-EO	3347A-DT 3547A-DT	3347A-NL 3547A-NL	3347A-NL-OP 3547A-NL-OP	3347A-TL 3547A-TL
Trim description	—	386DT	386NL	388	376T x 386
Base size	—	7 ¹⁵ / ₃₂ " x 1 ⁵ / ₈ " (190x41mm)	7 ¹⁵ / ₃₂ " x 1 ⁵ / ₈ " (190x41mm)	7 ¹⁵ / ₃₂ " x 1 ¹¹ / ₁₆ " (190x43mm)	7 ¹ / ₂ " x 1 ¹¹ / ₁₆ " x 7 ⁷ / ₈ " (190x43mmx22mm)
Grip size	—	8 ¹ / ₂ " x 4 ⁵ / ₁₆ " (216x110mm)	8 ¹ / ₂ " x 4 ⁵ / ₁₆ " (216x110mm)	—	8 ¹ / ₂ " x 4 ⁵ / ₁₆ " (216x110mm)
Projection	—	2 ⁷ / ₁₆ " (62mm)	2 ⁷ / ₁₆ " (62mm)	1" (25mm)	1 ³ / ₁₆ " (46mm)
ANSI function	01	02	03	03	11-12 field selectable
Cylinder type	—	—	Rim	Rim	1 ¹ / ₄ " Mortise
Handing	—	—	Handed	—	—
Optional trim	—	x 360L-DT x 550DT x IVES 8190	—	x 550DT x IVES 8190 10"	x 392-6

	TL-BE	L	L-BE	T	T-BE
					
	Thumbturn-blank escutcheon always operable (no cylinder)	Lever key locks and unlocks	Lever blank escutcheon always operable (no cylinder)	Thumbturn key locks and unlocks	Thumbturn always operable (no cylinder) (behind C/Case)
Product description	3347A-TL-BE 3547A-TL-BE	3347A-L 3547A-L	3347A-L-BE 3547A-L-BE	3347A-T 3547A-T	33477A-T-BE 35477A-T-BE
Trim description	376T-BE x 386	360L	360L-BE	360T	360T-BE
Base size	7 ¹ / ₂ " x 1 ¹¹ / ₁₆ " x 7 ⁷ / ₈ " (190x43x22mm)	7 ¹ / ₂ " x 1 ¹¹ / ₁₆ " x 7 ⁷ / ₈ " (190x43x22mm)	7 ¹ / ₂ " x 1 ¹¹ / ₁₆ " x 7 ⁷ / ₈ " (190x43x22mm)	7 ¹ / ₂ " x 1 ¹¹ / ₁₆ " x 7 ⁷ / ₈ " (190x43x22mm)	7 ¹ / ₂ " x 1 ¹¹ / ₁₆ " x 7 ⁷ / ₈ " (190x43x22mm)
Grip size	8 ¹ / ₂ " x 4 ⁵ / ₁₆ " (216x110mm)	—	—	—	—
Projection	2 ⁷ / ₁₆ " (62mm)	3" (76mm)	3" (76mm)	1 ³ / ₁₆ " (46mm)	1 ³ / ₁₆ " (46mm)
ANSI function	—	08 or 09 field selectable	—	11 or 12 field selectable	—
Cylinder type	—	1 ¹ / ₄ " Mortise	—	1 ¹ / ₄ " Mortise	—
Handing	—	Handed/Reversible	Handed/Reversible	—	—
Optional trim	x 392-6	—	E360L-BE	—	E360T-BE

Note: 360L & 360T used on wood door require the 33A-WDA cover plate 374T used on wood door require #10-WDA cover plate

Notes

3347A-F/3547A-F Concealed vertical rod fire exit device



3347A-F and 3547A-F for all types of double doors up to 8' x 10' (2438mm x 2540mm), UL listed for fire exit hardware. See page 47 for detailed information on UL listed fire exit hardware label and door opening size information. Devices are ANSI A156.3 – 2008 Grade 1. The 3547A-F has a smooth mechanism case and the 3347A-F has grooved case. The concealed vertical rod device is non-handed except when the SS (Signal Switch) option is used. See opposite page for available outside trim and device functions.

3347A-F/3547A-F fits door stiles as narrow as 3 1/2" (90mm). Newly designed device has a one piece center case cover.

Finishes – US3, US4, US10, US15 (35A Only) US26, US26D, US26D-AM, US28, 313 and 315.

Specifications

Device lengths	2' 2" (610 mm) Door size 3' 2 1/4" to 3' (660mm to 914 mm) door size 4' 2'8" to 4' (813 mm to 1219 mm) door size
Device centerline from finished floor	39 13/16" (1006mm)
Center case dimensions	8 13/16" x 2 13/32" x 1 9/16" (208mm x 62mm x 40mm)
Mechanism case dimensions	2 1/4" x 2 1/4" (57mm x 57mm)
Projection	Pushbar neutral – 3 13/16" (97 mm) Pushbar depressed – 3 1/16" (78 mm)
Latch bolt	Deadlocking anti-friction top & bottom bolt 5/8" (16mm) throw
Door undercut	1/4" (7mm)
Top & bottom latch	4 1/2" x 2 7/8" x 1 1/2" (114mm x 54mm x 38mm)
Vertical rods	Round 2 piece adjustable rods Top rod adjustable from 6'8" (2027mm) to 8'4" (2533mm) Bottom rod adjustable from 35 5/8" (905mm) to 49 5/8" (1260mm) Extension rod kits available for doors over 8'4" (2533mm)
Fasteners & sex bolts (SNB)	Includes 1 3/4" (44mm) – 2 1/4" (57mm) wood & metal doors #425 SNB furnished standard for end case #325 SNB furnished standard for EO (exit only device)
Electric options	ALK Alarm kit CX Chexit delayed exit EL Electric latch retraction HD-EL Electric latch retraction with hex dogging QEL Quiet electric latch retraction RX Request to exit, WP-RX waterproof option LX Latchbolt monitoring LX-RX Request to exit / latchbolt monitoring RX-LC, LX-LC, LX-RX-LC Low current option for RX, LX, LX-RX SS Signal switch CON Allegion Connect
Miscellaneous options	GBK Glass bead kit PN Pneumatic HH Hurricane LBR Less bottom rod SG Safety glow SEC Security screws SNB Sex bolts
Strikes	Top – 388 – Unfinished, bottom – 385A – Unfinished Optional strikes

QEL
Quiet electric latch retraction

- Bolt retraction via switch
- Converts exit door to push-pull operation

RX
Pushpad monitor switch

- Signals use of an opening
- SPDT switch to monitor pushpad

E (E360L)
Electric lever trim

- Electrified remote locking/unlocking
- Fail safe & fail secure options available
- No key override

ALK
Alarm exit kit

- Unauthorized opening triggers 85-decibel horn
- Set in armed or disarmed mode by key

EL
Electric latch retraction

- Enables remote unlatching
- Alternative to manual dogging





CON
Allegion Connectors





- Common connectors to connect various door hardware all the way to the power supply

PN
Pneumatic latch retraction

- For areas where electrical devices banned
- Special linkage for mechanical or pneumatic dogging

Standard trim

	EO	DT	NL	NL-OP	TL
					
	Exit only no outside trim	Dummy trim pull when dogged (not recommended for fire device)	Night latch key retracts latchbolt	Night latch key retracts latchbolt optional pull required	Thumbturn key locks & unlocks
Product description	3347A-EO-F 3547A-EO-F	3347A-DT-F 3547A-DT-F	3347A-NL-F 3547A-NL-F	3347A-NL-OP-F 3547A-NL-OP-F	3347A-TL-F 3547A-TL-F
Trim description	—	386DT	386NL	388	376T x 386
Base size	—	7 ¹⁵ / ₃₂ " x 1 ⁵ / ₈ " (190x41mm)	7 ¹⁵ / ₃₂ " x 1 ⁵ / ₈ " (190x41mm)	7 ¹⁵ / ₃₂ " x 1 ¹¹ / ₁₆ " (190x43mm)	7 ¹ / ₂ " x 1 ¹¹ / ₁₆ " x 7 ⁷ / ₈ " (190x43mmx22mm)
Grip size	—	8 ¹ / ₂ " x 4 ⁵ / ₁₆ " (216x110mm)	8 ¹ / ₂ " x 4 ⁵ / ₁₆ " (216x110mm)	—	8 ¹ / ₂ " x 4 ⁵ / ₁₆ " (216x110mm)
Projection	—	2 ⁷ / ₁₆ " (62mm)	2 ⁷ / ₁₆ " (62mm)	1" (25mm)	1 ³ / ₁₆ " (46mm)
ANSI function	01	02	03	03	11-12 Field selectable
Cylinder type	—	—	Rim	Rim	1 ¹ / ₄ " Mortise
Handing	—	—	Handed	—	—
Optional trim	—	x 360L-DT x 550DT x IVES 8190	—	x 550DT x IVES 8190 10"	x 392-6

	TL-BE	L	L-BE	T	T-BE
					
	Thumbturn-blank escutcheon always operable (no cylinder)	Lever key locks and unlocks	Lever blank escutcheon always operable (no cylinder)	Thumbturn key locks and unlocks (behind C/case)	Thumbturn always operable (no cylinder) (behind C/case)
Product description	3347A-TL-BE-F 3547A-TL-BE-F	3347A-L-F 3547A-L-F	3347A-L-BE-F 3547A-L-BE-F	3347A-T-F 3547A-T-F	3347A-T-BE-F 3547A-T-BE-F
Trim description	376T-BE x 386	360L	360L-BE	360T	360T-BE
Base size	7 ¹ / ₂ " x 1 ¹¹ / ₁₆ " x 7 ⁷ / ₈ " (190x43x22mm)	7 ¹ / ₂ " x 1 ¹¹ / ₁₆ " x 7 ⁷ / ₈ " (190x43x22mm)	7 ¹ / ₂ " x 1 ¹¹ / ₁₆ " x 7 ⁷ / ₈ " (190x43x22mm)	7 ¹ / ₂ " x 1 ¹¹ / ₁₆ " x 7 ⁷ / ₈ " (190x43x22mm)	7 ¹ / ₂ " x 1 ¹¹ / ₁₆ " x 7 ⁷ / ₈ " (190x43x22mm)
Grip size	8 ¹ / ₂ " x 4 ⁵ / ₁₆ " (216x110mm)	—	—	—	—
Projection	2 ⁷ / ₁₆ " (62mm)	3" (76mm)	3" (76mm)	1 ³ / ₁₆ " (46mm)	1 ³ / ₁₆ " (46mm)
ANSI function	—	08 or 09 field selectable	—	11 or 12 field selectable	—
Cylinder type	—	1 ¹ / ₄ " Mortise	—	1 ¹ / ₄ " Mortise	—
Handing	—	Handed/Reversible	Handed/Reversible	—	—
Optional trim	x 392-6	—	E360L-BE	—	E360T-BE

Note: 360L & 360T used on wood door require the 33A-WDA cover plate 374T used on wood door require #10-WDA cover plate

Notes

3348A/3548A Concealed vertical rod device



3348A and 3548A for hollow metal single and double doors, UL listed for panic exit hardware. Devices are ANSI A156.3 – 2008 Grade 1. The 3548A has a smooth mechanism case and the 3348A has grooved case. The concealed vertical rod device is non-handed except when the SS (Signal Switch) option is used. See opposite page for available outside trim and device functions.

3348A/3548A fits door stiles as narrow as 2 1/8" (44 mm). Newly designed device has a one piece center case cover.

Finishes – US3, US4, US10, US15 (35A Only) US26, US26D, US26D-AM, US28, 313 and 315.



Specifications

Device lengths	2' 2" (610 mm) Door size 3' 2'4" to 3' (660mm to 914 mm) door size 4' 2'8" to 4' (813 mm to 1219 mm) door size
Device centerline from finished floor	39 13/16" (1006mm) Standard, adjustable from 35 5/8" (905mm) to 49 5/8" (1260mm)
Center case dimensions	8 13/16" x 2 13/32" x 1 9/16" (208mm x 62mm x 40mm)
Mechanism case dimensions	2 1/4" x 2 1/4" (57mm x 57mm)
Projection	Pushbar neutral – 3 13/16" (97 mm) Pushbar depressed – 3 1/16" (78 mm)
Latch bolt	Deadlocking anti-friction top & bottom bolt 3/4" (19mm) throw Deadlocking anti-friction top & bottom bolt 1 1/2" (38mm) throw
Door undercut	3/4" (19mm)
Top & bottom latch	4 1/2" x 2 7/8" x 1 1/2" (114mm x 54mm x 38mm)
Vertical rods	Round 2 piece adjustable rods Top rod adjustable from 6'8" (2027mm) to 8'4" (2533mm) Bottom rod adjustable from 35 5/8" (905mm) to 49 5/8" (1260mm) Extension rod kits available for doors over 8'4" (2533mm)
Fasteners & sex bolts (SNB)	Includes 1 3/4" (44mm) – 2 1/4" (57mm) wood & metal doors #425 SNB furnished standard for end case #325 SNB furnished standard for EO (exit only device)
Electric options	ALK Alarm kit CX Chexit delayed exit EL Electric latch retraction HD-EL Electric latch retraction with hex dogging QEL Quiet electric latch retraction RX Request to exit, WP-RX waterproof option LX Latchbolt monitoring LX-RX Request to exit / latchbolt monitoring RX-LC, LX-LC, LX-RX-LC Low current option for RX, LX, LX-RX SS Signal switch CON Allegion Connect
Miscellaneous options	GBK Glass bead kit PN Pneumatic SG Safety glow SEC Security screws SNB Sex bolts
Dogging feature	Hex dogging standard CD Cylinder dogging LD Less dogging
Strikes	Top – 388 – Unfinished, bottom – 385A – Unfinished Optional strikes

QEL
Quiet electric latch retraction

- Bolt retraction via switch
- Converts exit door to push-pull operation

RX
Pushpad monitor switch

- Signals use of an opening
- SPDT switch to monitor pushpad

E (E360L)
Electric lever trim

- Electrified remote locking/unlocking
- Fail safe & fail secure options available
- No key override

ALK
Alarm exit kit

- Unauthorized opening triggers 85-decibel horn
- Set in armed or disarmed mode by key

EL
Electric latch retraction

- Enables remote unlatching
- Alternative to manual dogging

CON
Allegion Connectors

- Common connectors to connect various door hardware all the way to the power supply

DI
Dogging Indicator

- Monitor dogging status without a control panel
- Red indicator light shows visibility to dogging from over 75 feet





PN
Pneumatic latch retraction



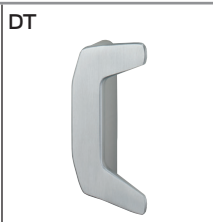

- For areas where electrical devices banned
- Special linkage for mechanical or pneumatic dogging

CD
Cylinder dogging

- Replaces hex key dogging
- Requires standard 1 1/4" mortise cylinder

Standard trim

	EO	DT	NL	NL-OP	TL
					
	Exit only no outside trim	Dummy trim pull when dogged	Night latch key retracts latchbolt	Night latch key retracts latchbolt optional pull required	Thumbturn key locks & unlocks
Product description	3348A-EO 3548A-EO	3348A-DT 3548A-DT	3348A-NL 3548A-NL	3348A-NL-OP 3548A-NL-OP	3348A-TL 3548A-TL
Trim description	—	386DT	386NL	388	376T x 386
Base size	—	7 ¹⁵ / ₃₂ " x 1 ⁵ / ₈ " (190x41mm)	7 ¹⁵ / ₃₂ " x 1 ⁵ / ₈ " (190x41mm)	7 ¹⁵ / ₃₂ " x 1 ¹¹ / ₁₆ " (190x43mm)	7 ¹ / ₂ " x 1 ¹¹ / ₁₆ " x 7 ⁷ / ₈ " (190x43mmx22mm)
Grip size	—	8 ¹ / ₂ " x 4 ⁵ / ₁₆ " (216x110mm)	8 ¹ / ₂ " x 4 ⁵ / ₁₆ " (216x110mm)	—	8 ¹ / ₂ " x 4 ⁵ / ₁₆ " (216x110mm)
Projection	—	2 ⁷ / ₁₆ " (62mm)	2 ⁷ / ₁₆ " (62mm)	1" (25mm)	1 ³ / ₁₆ " (46mm)
ANSI function	01	02	03	03	11-12 Field selectable
Cylinder type	—	—	Rim	Rim	1 ¹ / ₄ " Mortise
Handing	—	—	Handed	—	—
Optional trim	—	x 360L-DT x 550DT x IVES 8190	—	x 550DT x IVES 8190 10"	x 392-6

	TL-BE	L	L-BE	T	T-BE
					
	Thumbturn-blank escutcheon always operable (no cylinder)	Lever key locks and unlocks	Lever blank escutcheon always operable (no cylinder)	Thumbturn key locks and unlocks	Thumbturn always operable (no cylinder)
Product description	3348A-TL-BE 3548A-TL-BE	3348A-L 3548A-L	3348A-L-BE 3548A-L-BE	3348A-T 3548A-T	3348A-T-BE 3548A-T-BE
Trim description	376T-BE x 386	360L	360L-BE	360T	360T-BE
Base size	7 ¹ / ₂ " x 1 ¹¹ / ₁₆ " x 7 ⁷ / ₈ " (190x43x22mm)	7 ¹ / ₂ " x 1 ¹¹ / ₁₆ " x 7 ⁷ / ₈ " (190x43x22mm)	7 ¹ / ₂ " x 1 ¹¹ / ₁₆ " x 7 ⁷ / ₈ " (190x43x22mm)	7 ¹ / ₂ " x 1 ¹¹ / ₁₆ " x 7 ⁷ / ₈ " (190x43x22mm)	7 ¹ / ₂ " x 1 ¹¹ / ₁₆ " x 7 ⁷ / ₈ " (190x43x22mm)
Grip size	8 ¹ / ₂ " x 4 ⁵ / ₁₆ " (216x110mm)	—	—	—	—
Projection	2 ⁷ / ₁₆ " (62mm)	3" (76mm)	3" (76mm)	1 ³ / ₁₆ " (46mm)	1 ³ / ₁₆ " (46mm)
ANSI function	—	08 or 09 field selectable	—	11 or 12 field selectable	—
Cylinder type	—	1 ¹ / ₄ " Mortise	—	1 ¹ / ₄ " Mortise	—
Handing	—	Handed/Reversible	Handed/Reversible	—	—
Optional trim	x 392-6	—	E360L-BE	—	E360T-BE

Note: 360L & 360T used on wood door require the 33A-WDA cover plate 374T used on wood door require #10-WDA cover plate

Notes

3348A-F/3548A-F Concealed vertical rod fire exit device



3348A-F and 3548A-F for hollow metal single and double doors up to 8' x 10' (2438mm x 2540mm), UL listed for fire exit hardware. See page 47 for detailed information on UL listed fire exit hardware label and door opening size information. Devices are ANSI A156.3 – 2008 Grade 1. The 3548A-F has a smooth mechanism case and the 3348A-F has grooved case. The concealed vertical rod device is non-handed except when the SS (Signal Switch) option is used. See opposite page for available outside trim and device functions.

3348A-F/3548A-F fits door stiles as narrow as 3 1/2" (90mm). Newly designed device has a one piece center case cover.

Finishes – US3, US4, US10, US15 (35A Only) US26, US26D, US26D-AM, US28, 313 and 315.

Specifications

Device lengths	2' 2" (610 mm) Door size 3' 2'4" to 3' (660mm to 914 mm) door size 4' 2'8" to 4' (813 mm to 1219 mm) door size
Device centerline from finished floor	39 13/16" (1006mm) Standard, Adjustable from 35 5/8" (905mm) to 49 5/8" (1260mm)
Center case dimensions	8 13/16" x 2 13/32" x 1 9/16" (208mm x 62mm x 40mm)
Mechanism case dimensions	2 1/4" x 2 1/4" (57mm x 57mm)
Projection	Pushbar neutral – 3 13/16" (97 mm) Pushbar depressed – 3 1/16" (78 mm)
Latch bolt	Deadlocking anti-friction top & bottom bolt 3/4" (19mm) throw Deadlocking anti-friction top & bottom bolt 1 1/2" (38mm) throw
Door undercut	3/4" (19mm)
Top & bottom latch	4 1/4" x 1 1/2" x 1 1/8" (108mm x 38mm x 29mm)
Vertical rods	Round 2 piece adjustable rods Top rod adjustable from 6'8" (2027mm) to 8'4" (2533mm) Bottom rod adjustable from 35 5/8" (905mm) to 49 5/8" (1260mm) Extension rod kits available for doors over 8'4" (2533mm)
Fasteners & sex bolts (SNB)	Includes 1 3/4" (44mm) – 2 1/4" (57mm) wood & metal doors #425 SNB furnished standard for end case #325 SNB furnished standard for EO (exit only device)
Electric options	ALK Alarm kit CX Chexit delayed exit EL Electric latch retraction HD-EL Electric latch retraction with hex dogging QEL Quiet electric latch retraction RX Request to exit, WP-RX waterproof option LX Latchbolt monitoring LX-RX Request to exit / latchbolt monitoring RX-LC, LX-LC, LX-RX-LC Low current option for RX, LX, LX-RX SS Signal switch CON Allegion Connect
Miscellaneous options	GBK Glass bead kit PN Pneumatic SG Safety glow SEC Security screws SNB Sex bolts
Dogging feature	Hex dogging standard CD Cylinder dogging LD Less dogging
Strikes	Top – 388 – Unfinished, bottom – 385A – Unfinished Optional strikes

QEL
Quiet electric latch retraction

- Bolt retraction via switch
- Converts exit door to push-pull operation

RX
Pushpad monitor switch

- Signals use of an opening
- SPDT switch to monitor pushpad

E (E360L)
Electric lever trim

- Electrified remote locking/unlocking
- Fail safe & fail secure options available
- No key override

ALK
Alarm exit kit

- Unauthorized opening triggers 85-decibel horn
- Set in armed or disarmed mode by key

EL
Electric latch retraction

- Enables remote unlatching
- Alternative to manual dogging

SG
Safety glow

- Self illuminating touchpad
- No batteries or electronics





PN
Pneumatic latch retraction





- For areas where electrical devices banned
- Special linkage for mechanical or pneumatic dogging

CON
Allegion Connectors

- Common connectors to connect various door hardware all the way to the power supply

Standard trim

	EO	DT	NL	NL-OP	TL
					
	Exit only no outside trim	Dummy trim pull when dogged (not recommended for fire device)	Night latch key retracts latchbolt	Night latch key retracts latchbolt optional pull required	Thumbturn key locks & unlocks
Product description	3348A-EO-F 3548A-EO0F	3348A-DT-F 3548A-DT-F	3348A-NL-F 3548A-NL-F	3348A-NL-OP-F 3548A-NL-OP-F	3348A-TL-F 3548A-TL-F
Trim description	—	386DT	386NL	388	376T x 386
Base size	—	7 ¹⁵ / ₃₂ " x 1 ⁵ / ₈ " (190x41mm)	7 ¹⁵ / ₃₂ " x 1 ⁵ / ₈ " (190x41mm)	7 ¹⁵ / ₃₂ " x 1 ¹¹ / ₁₆ " (190x43mm)	7 ¹ / ₂ " x 1 ¹¹ / ₁₆ " x 7 ⁷ / ₈ " (190x43mmx22mm)
Grip size	—	8 ¹ / ₂ " x 4 ⁵ / ₁₆ " (216x110mm)	8 ¹ / ₂ " x 4 ⁵ / ₁₆ " (216x110mm)	—	8 ¹ / ₂ " x 4 ⁵ / ₁₆ " (216x110mm)
Projection	—	2 ⁷ / ₁₆ " (62mm)	2 ⁷ / ₁₆ " (62mm)	1" (25mm)	1 ³ / ₁₆ " (46mm)
ANSI function	01	02	03	03	11-12 field selectable
Cylinder type	—	—	Rim	Rim	1 ¹ / ₄ " Mortise
Handing	—	—	Handed	—	—
Optional trim	—	x 360L-DT x 550DT x IVES 8190	—	x 550DT x IVES 8190 10"	x 392-6

	TL-BE	L	L-BE	T	T-BE
					
	Thumbturn-blank escutcheon always operable (no cylinder)	Lever key locks and unlocks	Lever blank escutcheon always operable (no cylinder)	Thumbturn key locks and unlocks (behind C/Case)	Thumbturn always operable (no cylinder) (behind C/Case)
Product description	3348A-TL-BE-F 3548A-TL-BE-F	3348A-L-F 3548A-L-F	3348A-L-BE-F 3548A-L-BE-F	3348A-T-F 3548A-T-F	3348A-T-BE-F 3548A-T-BE-F
Trim description	376T-BE x 386	360L	360L-BE	360T	360T-BE
Base size	7 ¹ / ₂ " x 1 ¹¹ / ₁₆ " x 7 ⁷ / ₈ " (190x43x22mm)	7 ¹ / ₂ " x 1 ¹¹ / ₁₆ " x 7 ⁷ / ₈ " (190x43x22mm)	7 ¹ / ₂ " x 1 ¹¹ / ₁₆ " x 7 ⁷ / ₈ " (190x43x22mm)	7 ¹ / ₂ " x 1 ¹¹ / ₁₆ " x 7 ⁷ / ₈ " (190x43x22mm)	7 ¹ / ₂ " x 1 ¹¹ / ₁₆ " x 7 ⁷ / ₈ " (190x43x22mm)
Grip size	8 ¹ / ₂ " x 4 ⁵ / ₁₆ " (216x110mm)	—	—	—	—
Projection	2 ⁷ / ₁₆ " (62mm)	3" (76mm)	3" (76mm)	1 ³ / ₁₆ " (46mm)	1 ³ / ₁₆ " (46mm)
ANSI function	—	08 or 09 field selectable	—	11 or 12 field selectable	—
Cylinder type	—	1 ¹ / ₄ " Mortise	—	1 ¹ / ₄ " Mortise	—
Handing	—	Handed/Reversible	Handed/Reversible	—	—
Optional trim	x 392-6	—	E360L-BE	—	E360T-BE

Note: 360L & 360T used on wood door require the 33A-WDA cover plate 374T used on wood door require #10-WDA cover plate

Notes

3349A/3549A Concealed vertical cable device



3349A and 3549A for hollow metal single and double doors, UL listed for panic exit hardware. Devices are ANSI A156.3 – 2008 (LBL option 2014) Grade 1. The 3549A has a smooth mechanism case and the 3349A has grooved case. The concealed vertical cable device is non-handed except when the SS (signal switch) option is used. See opposite page for available outside trim and device functions.

3349A/3549A fits door stiles as narrow as 2 1/8" (44 mm). Newly designed device has a one piece center case cover.

Finishes – US3, US3A, US4, US4A, US10, US15 (3549 Only), US26, US26D, US26D-AM Antimicrobial, US28, 313, 315 and 643E.



Specifications

Device lengths	2' 2" (610 mm) Door size 3' 2 1/4" to 3' (660mm to 914 mm) door size 4' 2 8" to 4' (813 mm to 1219 mm) door size
Device centerline from finished floor	39 13/16" (1006mm)
Center case dimensions	8 13/16" x 2 13/32" x 1 9/16" (208mm x 62mm x 40mm)
Mechanism case dimensions	2 1/4" x 2 1/4" (57mm x 57mm)
Projection	Pushbar neutral – 3 13/16" (97 mm) Pushbar depressed – 3 1/16" (78 mm)
Latch bolt	Deadlocking anti-friction top & bottom bolt 1/2" (13mm) throw
Door undercut	3/4" (19mm) Maximum - 24231516 Spacer block kit needed for 3/4" (19mm) undercut
Top & bottom latch	5 13/16" x 1 1/4" x 1 7/16" (147mm x 32mm x 37mm)
Vertical cables	7/32" (6mm) Diameter stainless steel cables
Fasteners & sex bolts (SNB)	Includes 1 3/4" (44mm) – 2 1/4" (57mm) wood & metal doors #425 SNB furnished standard for end case #325 SNB furnished standard for EO (exit only device)
Electric options	ALK Alarm kit CX Chexit delayed exit EL Electric latch retraction HD-EL Electric latch retraction with hex dogging QEL Quiet electric latch retraction RX Request to exit, WP-RX waterproof option *LX Latchbolt monitoring *LX-RX Request to exit / latchbolt monitoring *RX-LC, LX-LC, LX-RX-LC Low current option for RX, LX, LX-RX SS Signal switch CON Allegion Connect
Mechanical options	AX Accessible device
Miscellaneous options	GBK Glass bead kit PL Pullman latch PN Pneumatic INS-2/INS-4 Insulclad Kits 1/2" / 1/4" panels LBL Less bottom latch SG Safety glow SEC Security screws SNB Sex bolts
Dogging feature	Hex dogging standard CD Cylinder dogging LD Less dogging
Strikes	Top – 249 Bottom – 349

QEL
Quiet electric latch retraction
 • Bolt retraction via switch
 • Converts exit door to push-pull operation

AX
Accessible device
 • UL certified to meet new 5 lb. maximum operating force requirement
 • Exceeds ANSI/BHMA requirements

E (E360L)
Electric lever trim
 • Electrified remote locking/unlocking
 • Fail safe & fail secure options available
 • No key override

ALK
Alarm exit kit
 • Unauthorized opening triggers 85-decibel horn
 • Set in armed or disarmed mode by key

EL
Electric latch retraction
 • Enables remote unlatching
 • Alternative to manual dogging

CON
Allegion Connectors
 • Common connectors to connect various door hardware all the way to the power supply

DI
Dogging Indicator
 • Monitor dogging status without a control panel
 • Red indicator light shows visibility to dogging from over 75 feet

RX
Pushpad monitor switch
 • Signals use of an opening
 • SPDT switch to monitor pushpad





CD
Cylinder dogging
 • Replaces hex key dogging
 • Requires standard 1 1/4" mortise cylinder





PN
Pneumatic latch retraction
 • For areas where electrical devices banned
 • Special linkage for mechanical or pneumatic dogging

*For 33/3549A devices, LX switch monitors trim input or electric dogging of EL/QEL devices. LX switch does not monitor latchbolt condition.

3349A/3549A Concealed vertical cable device

Standard trim

	EO	DT	NL	NL-OP
				
	Exit only no outside trim	Dummy trim pull when dogged	Night latch key retracts latchbolt	Night latch key retracts latchbolt optional pull required
Product description	3349A-EO 3549A-EO	3349A-DT 3549A-DT	3349A-NL 3549A-NL	3349A-NL-OP 3549A-NL-OP
Trim description	—	386DT	386NL	388
Base size	—	7 ¹⁵ / ₃₂ " x 1 ⁵ / ₈ " (190x41mm)	7 ¹⁵ / ₃₂ " x 1 ⁵ / ₈ " (190x41mm)	7 ¹⁵ / ₃₂ " x 1 ¹¹ / ₁₆ " (190x43mm)
Grip size	—	8 ¹ / ₂ " x 4 ⁵ / ₁₆ " (216x110mm)	8 ¹ / ₂ " x 4 ⁵ / ₁₆ " (216x110mm)	—
Projection	—	2 ⁷ / ₁₆ " (62mm)	2 ⁷ / ₁₆ " (62mm)	1" (25mm)
ANSI function	01	02	03	03
Cylinder type	—	—	Rim	Rim
Handing	—	—	Handed	—
Optional trim	—	x 360L-DT x 550DT x IVES 8190	—	x 550DT x IVES 8190 10"

	L	L-BE	T	T-BE
				
	Lever key locks and unlocks	Lever blank escutcheon always operable (no cylinder)	Thumbturn key locks and unlocks (behind C/case)	Thumbturn always operable (no cylinder) (behind C/case)
Product description	3349A-L 3549A-L	3349A-L-BE 3549A-L-BE	3349A-T 3549A-T	3349A-T-BE 3549A-T-BE
Trim description	360L	360L-BE	360T	360T-BE
Base size	7 ¹ / ₂ " x 1 ¹¹ / ₁₆ " x 7 ⁷ / ₈ " (190x43x22mm)	7 ¹ / ₂ " x 1 ¹¹ / ₁₆ " x 7 ⁷ / ₈ " (190x43x22mm)	7 ¹ / ₂ " x 1 ¹¹ / ₁₆ " x 7 ⁷ / ₈ " (190x43x22mm)	7 ¹ / ₂ " x 1 ¹¹ / ₁₆ " x 7 ⁷ / ₈ " (190x43x22mm)
Grip size	—	—	—	—
Projection	3" (76mm)	3" (76mm)	1 ³ / ₁₆ " (46mm)	1 ³ / ₁₆ " (46mm)
ANSI function	08 or 09 field selectable	—	11 or 12 field selectable	—
Cylinder type	1 ¹ / ₄ " Mortise	—	1 ¹ / ₄ " Mortise	—
Handing	Handed/Reversible	Handed/Reversible	—	—
Optional trim	—	E360L-BE	—	E360T-BE

Nominal door opening height		Top cable part number	Bottom cable part number
*82" - 96"	*6'10" - 8'	47250175	47250178
>96" - 110"	>8'0" - 9' 2"	47250176	47250179
>110" - 120"	>9'2" - 10'	47250177	47250180

*Default door opening height. Specify door opening height if other than the default. For door heights less than 6'10" and greater than 10', contact our Customer Care department to discuss your specific application needs.

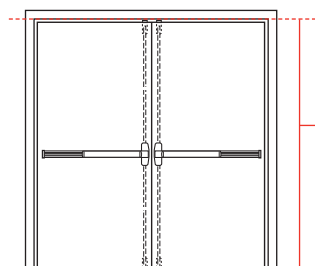

Door opening height is distance from bottom of frame header to finished floor.

See table on left for standard offering.

3349A-F/3549A-F Concealed vertical cable fire exit device



3349A-F and 3549A-F for hollow metal single and double doors up to 8' x 10' (2438mm x 2540mm), UL listed for fire exit hardware. See page 47 for detailed information on UL listed fire exit hardware label and door opening size information. Devices are ANSI A156.3 – 2008 (LBL option 2014) Grade 1. The 3549A-F has a smooth mechanism case and the 3349A-F has grooved case. The concealed vertical cable device is non-handed except when the SS (signal switch) option is used. See opposite page for available outside trim and device functions.

3349A-F/3529A-F fits door stiles as narrow as 3 1/2" (90mm). Newly designed device has a one piece center case cover.

Finishes – US3, US3A, US4, US4A, US10, US15 (3549 Only), US26, US26D, US26D-AM Antimicrobial, US28, 313, 315 and 643E.



Specifications

Device lengths	2' 2" (610 mm) Door size 3' 2 1/4" to 3' (660mm to 914 mm) door size 4' 2 1/8" to 4' (813 mm to 1219 mm) door size
Device centerline from finished floor	39 13/16" (1006mm) Standard
Center case dimensions	8 13/16" x 2 13/32" x 1 9/16" (208mm x 62mm x 40mm)
Mechanism case dimensions	2 1/4" x 2 1/4" (57mm x 57mm)
Projection	Pushbar neutral – 3 13/16" (97 mm) Pushbar depressed – 3 1/16" (78 mm)
Latch bolt	Deadlocking anti-friction top & bottom bolt 1/2" (13mm) throw
Door undercut	3/4" (19mm) Maximum - 24231516 Spacer block kit needed for 3/4" (19mm) undercut
Top & bottom latch	5 13/16" x 1 1/4" x 1 7/16" (147mm x 32mm x 37mm)
Vertical cables	7/32" (6mm) Diameter stainless steel cables
Fasteners & sex bolts (SNB)	Includes 1 3/4" (44mm) – 2 1/4" (57mm) wood & metal doors #425 SNB furnished standard for end case #325 SNB furnished standard for EO (exit only device)
Electric options	ALK Alarm kit CX Chexit delayed exit EL Electric latch retraction HD-EL Electric latch retraction with hex dogging QEL Quiet electric latch retraction RX Request to exit, WP-RX waterproof option *LX Latchbolt monitoring *LX-RX Request to exit / latchbolt monitoring *RX-LC, LX-LC, LX-RX-LC Low current option for RX, LX, LX-RX SS Signal switch CON Allegion Connect
Mechanical options	AX Accessible device
Miscellaneous options	GBK Glass bead kit PN Pneumatic LBL Less bottom latch SG Safety glow SEC Security screws SNB Sex bolts
Strikes	Top – 249 Bottom – 349

QEL

Quiet electric latch retraction

- Bolt retraction via switch
- Converts exit door to push-pull operation

AX

Accessible device

- UL certified to meet new 5 lb. maximum operating force requirement
- Exceeds ANSI/BHMA requirements

E (E360L)

Electric lever trim

- Electrified remote locking/unlocking
- Fail safe & fail secure options available
- No key override

ALK

Alarm exit kit

- Unauthorized opening triggers 85-decibel horn
- Set in armed or disarmed mode by key

EL

Electric latch retraction

- Enables remote unlatching
- Alternative to manual dogging

SG

Safety glow

- Self illuminating touchpad
- No batteries or electronics

CON

Allegion Connectors

- Common connectors to connect various door hardware all the way to the power supply

RX

Pushpad monitor switch

- Signals use of an opening
- SPDT switch to monitor pushpad





PN





Pneumatic latch retraction

- For areas where electrical devices banned
- Special linkage for mechanical or pneumatic dogging

*For 33/3549A devices, LX switch monitors trim input or electric dogging of EL/QEL devices. LX switch does not monitor latchbolt condition.

Standard trim

	EO	DT	NL	NL-OP
				
	Exit only no outside trim	Dummy trim pull when dogged	Night latch key retracts latchbolt	Night latch key retracts latchbolt optional pull required
Product description	3349A-EO-F 3549A-EO-F	3349A-DT-F 3549A-DT-F	3349A-NL-F 3549A-NL-F	3349A-NL-OP-F 3549A-NL-OP-F
Trim description	—	386DT	386NL	388
Base size	—	7 ¹⁵ / ₃₂ " x 1 ⁵ / ₈ " (190x41mm)	7 ¹⁵ / ₃₂ " x 1 ⁵ / ₈ " (190x41mm)	7 ¹⁵ / ₃₂ " x 1 ¹¹ / ₁₆ " (190x43mm)
Grip size	—	8 ¹ / ₂ " x 4 ⁵ / ₁₆ " (216x110mm)	8 ¹ / ₂ " x 4 ⁵ / ₁₆ " (216x110mm)	—
Projection	—	2 ⁷ / ₁₆ " (62mm)	2 ⁷ / ₁₆ " (62mm)	1" (25mm)
ANSI function	01	02	03	03
Cylinder type	—	—	Rim	Rim
Handing	—	—	Handed	—
Optional trim	—	x 360L-DT x 550DT x IVES 8190	—	x 550DT x IVES 8190 10"

	L	L-BE	T	T-BE
				
	Lever key locks and unlocks	Lever blank escutcheon always operable (no cylinder)	Thumbturn key locks and unlocks (behind C/case)	Thumbturn always operable (no cylinder) (behind C/case)
Product description	3349A-L-F 3549A-L-F	3349A-L-BE-F 3549A-L-BE-F	3349A-T-F 3549A-T-F	3349A-T-BE-F 3549A-T-BE-F
Trim description	360L	360L-BE	360T	360T-BE
Base size	7 ¹ / ₂ " x 1 ¹¹ / ₁₆ " x 7 ⁷ / ₈ " (190x43x22mm)	7 ¹ / ₂ " x 1 ¹¹ / ₁₆ " x 7 ⁷ / ₈ " (190x43x22mm)	7 ¹ / ₂ " x 1 ¹¹ / ₁₆ " x 7 ⁷ / ₈ " (190x43x22mm)	7 ¹ / ₂ " x 1 ¹¹ / ₁₆ " x 7 ⁷ / ₈ " (190x43x22mm)
Grip size	—	—	—	—
Projection	3" (76mm)	3" (76mm)	1 ³ / ₁₆ " (46mm)	1 ³ / ₁₆ " (46mm)
ANSI function	08 or 09 field selectable	—	11 or 12 field selectable	—
Cylinder type	1 ¹ / ₄ " Mortise	—	1 ¹ / ₄ " Mortise	—
Handing	Handed/Reversible	Handed/Reversible	—	—
Optional trim	—	E360L-BE	—	E360T-BE

Nominal door opening height		Top cable part number	Bottom cable part number
*82" - 96"	*6'10" - 8'	47250175	47250178
>96" - 110"	>8'0" - 9' 2"	47250176	47250179
>110" - 120"	>9'2" - 10'	47250177	47250180

*Default door opening height. Specify door opening height if other than the default. For door heights less than 6'10" and greater than 10', contact our Customer Care department to discuss your specific application needs.

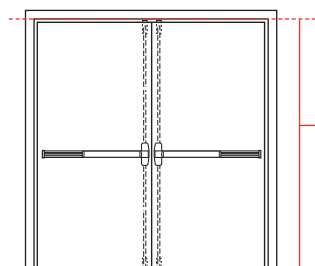

Door opening height is distance from bottom of frame header to finished floor.

See table on left for standard offering.

3350AWDC/3550AWDC Wood door concealed vertical cable device



3350AWDC and 3550AWDC for use on single and double wood doors, UL listed for panic exit hardware. Devices are ANSI A156.3 – 2008 Grade 1. The 3549A has a smooth mechanism case and the 3350AWDC has grooved case. The concealed vertical cable device is non-handed except when the SS (signal switch) option is used. See opposite page for available outside trim and device functions.

3350AWDC/3550AWDC fits door stiles as narrow as 2 1/8" (44 mm).

Scalp Plate – Device is furnished standard with an 15" (381 mm) long scalp plate for easy access to cables.

Finishes – US3, US3A, US4, US4A, US10, US15 (3550AWDC Only), US26, US26D, US26D-AM Antimicrobial, US28, 313, 315 and 643E.

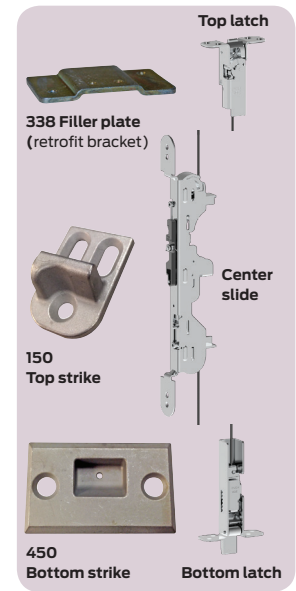

Specifications

Device lengths	2' 2" (610 mm) Door size 3' 2'4" to 3' (660mm to 914 mm) door size 4' 2'8" to 4' (813 mm to 1219 mm) door size
Device centerline from finished floor	39 13/16" (1006mm)
Center case dimensions	8 13/16" x 2 13/32" x 1 9/16" (208mm x 62mm x 40mm)
Mechanism case dimensions	2 1/4" x 2 1/4" (57mm x 57mm)
Projection	Pushbar neutral – 3 13/16" (97 mm) Pushbar depressed – 3 1/16" (78 mm)
Latch bolt	Deadlocking anti-friction top & bottom bolt 1/2" (13mm) throw
Door undercut	3/4" (19mm) Maximum
Top & bottom latch	5 13/16" x 1 1/4" x 1 7/16" (147mm x 32mm x 37mm)
Vertical cables	7/32" (6mm) Diameter stainless steel cables
Fasteners & sex bolts (SNB)	Includes 1 3/4" (44mm) – 2 1/4" (57mm) wood doors #425 SNB furnished standard for end case #325 SNB furnished standard for EO (exit only device)
Electric options	ALK Alarm kit CX Chexit delayed exit EL Electric latch retraction HD-EL Electric latch retraction with hex dogging QEL Quiet electric latch retraction RX Request to exit, WP-RX waterproof option *LX Latchbolt monitoring *LX-RX Request to exit / latchbolt monitoring *RX-LC, LX-LC, LX-RX-LC Low current option for RX, LX, LX-RX SS Signal switch CON Allegion Connect
Miscellaneous options	GBK Glass bead kit PL Pullman latch PN Pneumatic INS-2/INS-4 Insulclad Kits 1/2" / 1/4" panels LBL Less bottom latch SG Safety glow SEC Security screws SNB Sex bolts
Dogging feature	Hex dogging standard CD Cylinder dogging LD Less dogging
Strikes	Top – 150 Bottom – 450

QEL
Quiet electric latch retraction
 • Bolt retraction via switch
 • Converts exit door to push-pull operation

PN
Pneumatic latch retraction
 • For areas where electrical devices banned
 • Special linkage for mechanical or pneumatic dogging

E (E360L)
Electric lever trim
 • Electrified remote locking/unlocking
 • Fail safe & fail secure options available
 • No key override

ALK
Alarm exit kit
 • Unauthorized opening triggers 85-decibel horn
 • Set in armed or disarmed mode by key

EL
Electric latch retraction
 • Enables remote unlatching
 • Alternative to manual dogging

CON
Allegion Connectors
 • Common connectors to connect various door hardware all the way to the power supply





DI
Dogging Indicator
 • Monitor dogging status without a control panel
 • Red indicator light shows visibility to dogging from over 75 feet





RX
Pushpad monitor switch
 • Signals use of an opening
 • SPDT switch to monitor pushpad

CD
Cylinder dogging
 • Replaces hex key dogging
 • Requires standard 1 1/4" mortise cylinder

*For 33/3550AWDC devices, LX switch monitors trim input or electric dogging of EL/QEL devices. LX switch does not monitor latchbolt condition.

Standard trim

	EO	DT	NL	NL-OP
				
	Exit only no outside trim	Dummy trim pull when dogged	Night latch key retracts latchbolt	Night latch key retracts latchbolt optional pull required
Product description	3350AWDC-EO 3550AWDC-EO	33950AWDC-DT 3550AWDC-DT	3350AWDC-NL 3550AWDC-NL	3350AWDC-NL-OP 3550AWDC-NL-OP
Trim description	—	386DT	386NL	388
Base size	—	7 ¹⁵ / ₃₂ " x 1 ⁵ / ₈ " (190x41mm)	7 ¹⁵ / ₃₂ " x 1 ⁵ / ₈ " (190x41mm)	7 ¹⁵ / ₃₂ " x 1 ¹¹ / ₁₆ " (190x43mm)
Grip size	—	8 ¹ / ₂ " x 4 ⁵ / ₁₆ " (216x110mm)	8 ¹ / ₂ " x 4 ⁵ / ₁₆ " (216x110mm)	—
Projection	—	2 ⁷ / ₁₆ " (62mm)	2 ⁷ / ₁₆ " (62mm)	1" (25mm)
ANSI function	01	02	03	03
Cylinder type	—	—	Rim	Rim
Handing	—	—	Handed	—
Optional trim	—	x 360L-DT x 550DT x IVES 8190	—	x 550DT x IVES 8190 10"

	L	L-BE	T	T-BE
				
	Lever key locks and unlocks	Lever blank escutcheon always operable (no cylinder)	Thumbturn key locks and unlocks (behind C/case)	Thumbturn always operable (no cylinder) (behind C/case)
Product description	3350AWDC-L 3550AWDC-L	3350AWDCA-L-BE 3550AWDC-L-BE	3350AWDC-T 3550AWDC-T	3350AWDC-T-BE 3550AWDC-T-BE
Trim description	360L	360L-BE	360T	360T-BE
Base size	7 ¹ / ₂ " x 1 ¹¹ / ₁₆ " x 7 ⁷ / ₈ " (190x43x22mm)	7 ¹ / ₂ " x 1 ¹¹ / ₁₆ " x 7 ⁷ / ₈ " (190x43x22mm)	7 ¹ / ₂ " x 1 ¹¹ / ₁₆ " x 7 ⁷ / ₈ " (190x43x22mm)	7 ¹ / ₂ " x 1 ¹¹ / ₁₆ " x 7 ⁷ / ₈ " (190x43x22mm)
Grip size	—	—	—	—
Projection	3" (76mm)	3" (76mm)	1 ³ / ₁₆ " (46mm)	1 ³ / ₁₆ " (46mm)
ANSI function	08 or 09 field selectable	—	11 or 12 field selectable	—
Cylinder type	1 ¹ / ₄ " Mortise	—	1 ¹ / ₄ " Mortise	—
Handing	Handed/Reversible	Handed/Reversible	—	—
Optional trim	—	E360L-BE	—	E360T-BE

Standard door opening height
Feet (Inches)
6'8" - 7' (72" - 84")
7'1" - 8' (85" - 96")
8'1" - 9' (97" - 108")
9'1" - 10' (109" - 120")

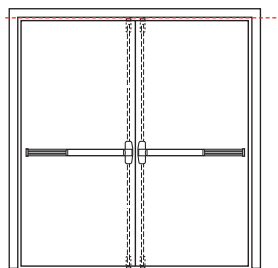

Door Opening Height
is measured from finished floor
to frame rabbet on door side.

See table on left for standard offering.

Note: Non-standard sizes available with extended lead time. Consult Customer Care for more information 1-877-671-7011.

3350AWDC-F/3550AWDC-F Concealed vertical cable fire exit device



3350AWDC-F and 3550AWDC-F for use on single and double wood doors up to 8' x 10' (2438mm x 2540mm), UL listed for fire exit hardware. See page 47 for detailed information on UL listed fire exit hardware label and door opening size information. Devices are ANSI A156.3 – 2008 Grade 1. The 3550AWDC-F has a smooth mechanism case and the 3350AWDC-F has grooved case. The concealed vertical cable device is non-handed except when the SS (signal switch) option is used. See opposite page for available outside trim and device functions.

3350AWDC-F/3550AWDC-F fits narrow stile doors.

Scalp Plate – Device is furnished standard with an 15" (381 mm) long scalp plate for easy access to cables.

Finishes – US3, US3A, US4, US4A, US10, US15 (3550AWDC Only), US26, US26D, US26D-AM Antimicrobial, US28, 313, 315 and 643E.

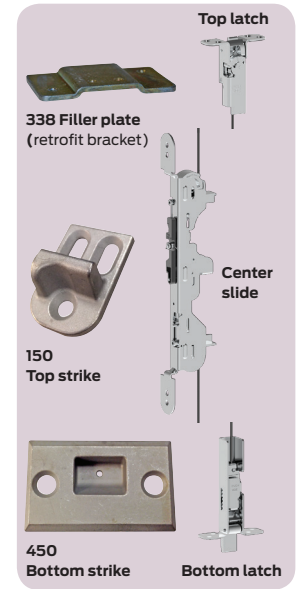

Specifications

Device lengths	2' 2" (610 mm) Door size 3' 2'4" to 3' (660mm to 914 mm) door size 4' 2'8" to 4' (813 mm to 1219 mm) door size
Device centerline from finished floor	39 ¹³ / ₁₆ " (1006mm) Standard
Center case dimensions	8 ¹³ / ₁₆ " x 2 ¹³ / ₃₂ " x 1 ⁹ / ₁₆ " (208mm x 62mm x 40mm)
Mechanism case dimensions	2 ¹ / ₄ " x 2 ¹ / ₄ " (57mm x 57mm)
Projection	Pushbar neutral – 3 ¹³ / ₁₆ " (97 mm) Pushbar depressed – 3 ¹ / ₁₆ " (78 mm)
Latch bolt	Deadlocking anti-friction top & bottom bolt 1/2" (13mm) throw
Door undercut	3/4" (19mm) Maximum
Top & bottom latch	5 ¹³ / ₁₆ " x 1 ¹ / ₄ " x 1 ⁷ / ₁₆ " (147mm x 32mm x 37mm)
Vertical cables	7/32" (6mm) Diameter stainless steel cables
Fasteners & sex bolts (SNB)	Includes 1 ³ / ₄ " (44mm) – 2 ¹ / ₄ " (57mm) wood doors #425 SNB furnished standard for end case #325 SNB furnished standard for EO (exit only device)
Electric options	ALK Alarm kit CX Chexit delayed exit EL Electric latch retraction HD-EL Electric latch retraction with hex dogging QEL Quiet electric latch retraction RX Request to exit, WP-RX waterproof option *LX Latchbolt monitoring *LX-RX Request to exit / latchbolt monitoring *RX-LC, LX-LC, LX-RX-LC Low current option for RX, LX, LX-RX SS Signal switch CON Allegion Connect
Miscellaneous options	GBK Glass bead kit PN Pneumatic LBL Less bottom latch SG Safety glow SEC Security screws SNB Sex bolts
Strikes	Top – 150 Bottom – 450

QEL
Quiet electric latch retraction
 • Bolt retraction via switch
 • Converts exit door to push-pull operation

PN
Pneumatic latch retraction
 • For areas where electrical devices banned
 • Special linkage for mechanical or pneumatic dogging

E (E360L)
Electric lever trim
 • Electrified remote locking/unlocking
 • Fail safe & fail secure options available
 • No key override

ALK
Alarm exit kit
 • Unauthorized opening triggers 85-decibel horn
 • Set in armed or disarmed mode by key

EL
Electric latch retraction
 • Enables remote unlatching
 • Alternative to manual dogging





SG
Safety glow
 • Self illuminating touchpad
 • No batteries or electronics





CON
Allegion Connectors
 • Common connectors to connect various door hardware all the way to the power supply

RX
Pushpad monitor switch
 • Signals use of an opening
 • SPDT switch to monitor pushpad

*For 33/3550AWDC devices, LX switch monitors trim input or electric dogging of EL/QEL devices. LX switch does not monitor latchbolt condition.

Standard trim

	EO	DT	NL	NL-OP
				
	Exit only no outside trim	Dummy trim pull when dogged	Night latch key retracts latchbolt	Night latch key retracts latchbolt optional pull required
Product description	3350AWDC-EO-F 3550AWDC-EO-F	3350AWDC-DT-F 3550AWDC-DT-F	3350AWDC-NL-F 3550AWDC-NL-F	3350AWDC-NL-OP-F 3550AWDC-NL-OP-F
Trim description	—	386DT	386NL	388
Base size	—	7 ¹⁵ / ₃₂ " x 1 ⁵ / ₈ " (190x41mm)	7 ¹⁵ / ₃₂ " x 1 ⁵ / ₈ " (190x41mm)	7 ¹⁵ / ₃₂ " x 1 ¹¹ / ₁₆ " (190x43mm)
Grip size	—	8 ¹ / ₂ " x 4 ⁵ / ₁₆ " (216x110mm)	8 ¹ / ₂ " x 4 ⁵ / ₁₆ " (216x110mm)	—
Projection	—	2 ⁷ / ₁₆ " (62mm)	2 ⁷ / ₁₆ " (62mm)	1" (25mm)
ANSI function	01	02	03	03
Cylinder type	—	—	Rim	Rim
Handing	—	—	Handed	—
Optional trim	—	x 360L-DT x 550DT x IVES 8190	—	x 550DT x IVES 8190 10"

	L	L-BE	T	T-BE
				
	Lever key locks and unlocks	Lever blank escutcheon always operable (no cylinder)	Thumbturn key locks and unlocks (behind C/case)	Thumbturn always operable (no cylinder) (behind C/case)
Product description	3350AWDC-L-F 3550AWDC-L-F	3350AWDC-L-BE-F 3550AWDC-L-BE-F	3350AWDC-T-F 3550AWDC-T-F	3350AWDC-T-BE-F 3550AWDC-T-BE-F
Trim description	360L	360L-BE	360T	360T-BE
Base size	7 ¹ / ₂ " x 1 ¹¹ / ₁₆ " x 7 ⁷ / ₈ " (190x43x22mm)	7 ¹ / ₂ " x 1 ¹¹ / ₁₆ " x 7 ⁷ / ₈ " (190x43x22mm)	7 ¹ / ₂ " x 1 ¹¹ / ₁₆ " x 7 ⁷ / ₈ " (190x43x22mm)	7 ¹ / ₂ " x 1 ¹¹ / ₁₆ " x 7 ⁷ / ₈ " (190x43x22mm)
Grip size	—	—	—	—
Projection	3" (76mm)	3" (76mm)	1 ³ / ₁₆ " (46mm)	1 ³ / ₁₆ " (46mm)
ANSI function	08 or 09 field selectable	—	11 or 12 field selectable	—
Cylinder type	1 ¹ / ₄ " Mortise	—	1 ¹ / ₄ " Mortise	—
Handing	Handed/Reversible	Handed/Reversible	—	—
Optional trim	—	E360L-BE	—	E360T-BE

Standard door opening height
Feet (Inches)
6'8" - 7' (72" - 84")
7'1" - 8' (85" - 96")
8'1" - 9' (97" - 108")
9'1" - 10' (109" - 120")

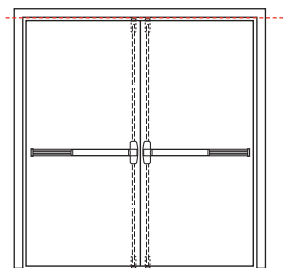

Door opening height
is measured from finished floor
to frame rabbet on door side.

See table on left for standard offering.



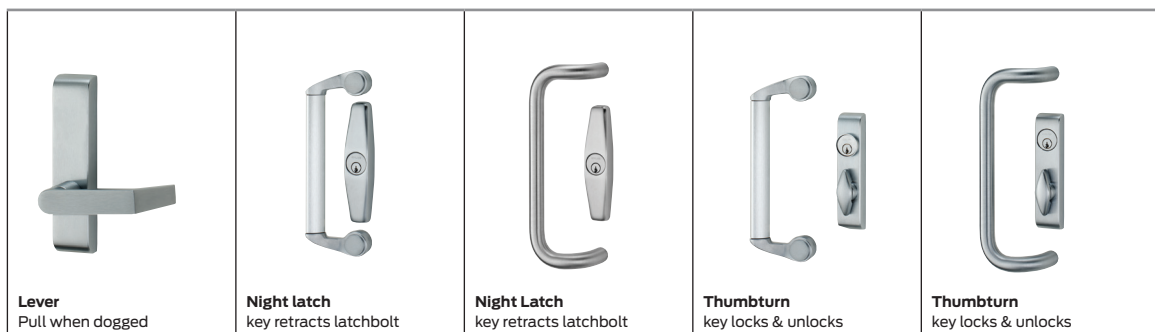

Note: Non-standard sizes available with extended lead time. Consult Customer Care for more information 1-877-671-7011.

33A/35A Optional trim



	Lever Pull when dogged	Night latch key retracts latchbolt	Night Latch key retracts latchbolt	Thumbturn key locks & unlocks	Thumbturn key locks & unlocks
Trim description	360L-DT	388 x 550DT	388 x IVES 8190 10"	360T x 550DT	360T x IVES 8190 10"
Base size	7½ x 1⅞" x 7⁄8" (190x43mmx22mm)	7½ x 1⅞" (190x43mm)	7½ x 1⅞" (190x43mm)	7½ x 1⅞" x 7⁄8" (190x43mmx22mm)	7½ x 1⅞" x 7⁄8" (190x43mmx22mm)
Grip size	—	10" center to center	10" center to center	10" center to center	10" center to center
Projection	3" (76mm)	1" (25mm)	1" (25mm)	1⅜" (46mm)	1⅜" (46mm)
ANSI function	02	03	03	11/12 Field selectable	11/12 Field selectable
Cylinder type	—	Rim	Rim	1¼" Mortise	1¼" Mortise
Handing	Handed / Reversible	—	—	—	—

33A/35A Optional trim

					
	Thumbturn-blank escutcheon always operable (no cylinder)	Thumbturn-blank escutcheon always operable (no cylinder)	Thumbturn key locks & unlocks	Thumbturn-blank escutcheon always operable (no cylinder)	Offset pull
Trim description	360T-BE x 550 DT	360T-BE x 8190 10"	374T/376T x 8190 10"	374T-BE/376T-BE x 8190 10"	392-6
Base size	7½ x 1 ¹¹ / ₁₆ " x 7 ⁷ / ₈ " (190x43mmx22mm)	7½ x 1 ¹¹ / ₁₆ " x 7 ⁷ / ₈ " (190x43mmx22mm)	7½ x 1 ¹¹ / ₁₆ " x 7 ⁷ / ₈ " (190x43mmx22mm)	7½ x 1 ¹¹ / ₁₆ " x 7 ⁷ / ₈ " (190x43mmx22mm)	7 x 3 ½" x ¾" (178x89mmx19mm)
Grip size	11 ⁹ / ₁₆ " center to center	1" center to center	8½" x 4 ⁵ / ₁₆ " (216x110mm)	8½" x 4 ⁵ / ₁₆ " (216x110mm)	6¼" center to center
Projection	1 ¹³ / ₁₆ " (46mm)	1 ¹³ / ₁₆ " (46mm)	1 ¹³ / ₁₆ " (46mm)	1 ¹³ / ₁₆ " (46mm)	2¼"
ANSI function	—	—	11-12 Field selectable	—	—
Cylinder type	—	—	1¼" Mortise	—	—
Handing	—	—	—	—	—

Note: 360L & 360T used on Wood Door require the 33A-WDA cover plate
376T used on Wood Door require #10-WDA cover plate

33A/35A Strike/Stile information

Device type	Standard single door		Standard double door		Optional single door		Optional double door	
	Strike	Stile	Strike w/mullion	Stile	Strike	Stile	Strike w/mullion	Stile
33A 35A	1439	2" (51mm)	1408 x 5754	2" (51mm)	299 1410 1606	2 ³ / ₄ " (70mm) 1 ³ / ₄ " (44mm) 2 ¹ / ₂ " (64mm)	299 x 5654 299 x 4954 1606 x 1654	2 ⁵ / ₈ " (67mm) 3 ⁵ / ₁₆ " (84mm) 2 ³ / ₄ " (70mm)
3327A 3527A	266 (Top) 304L (Bottom) 248-L (Bottom)	2 ¹ / ₈ " (54mm)	266 (Top) 304L (Bottom) 248-L (Bottom)	1 ³ / ₄ " (44mm)	299 (Top) 385A (Bottom) 260U (Top) 385A (Bottom)	3 ¹ / ₈ " (79mm) 2 ¹ / ₈ " (54mm)	299 (Top) 385A (Bottom) 260U (Top) 385A (Bottom)	3 ¹ / ₈ " (79mm) 2 ¹ / ₈ " (54mm)
3327A-F 3527A-F	—	—	299F (Top) 304L (Bottom)	2 ³ / ₁₆ " (56mm)	—	—	—	—
3327A-LBR-F	—	—	499F (Top) (Req. auxiliary fire latch)	3 ⁵ / ₈ " (92mm)	—	—	—	—
3347A 3547A 3348A 3548A	338 (Top) 385A (Bottom)	2 ¹ / ₈ " (54mm)	338 (Top) 385A (Bottom)	1 ³ / ₄ " (44mm)	304L (Bottom)	2 ¹ / ₂ " (64mm)	304L (Bottom)	2 ¹ / ₂ " (64mm)
3347A-F 3547A-F 3348A-F 3548A-F	—	—	338 (Top) 385A (Bottom)	3 ¹ / ₂ " (89mm)	—	—	304L (Bottom)	3 ¹ / ₂ " (89mm)
3347A-LBR 3547A-LBR 3348A-LBR 3548A-LBR	338 (Top)	2 ¹ / ₂ " (64mm)	338 (Top)	2 ¹ / ₂ " (64mm)	—	—	—	—
3347A-LBR-F 3547A-LBR-F	—	—	338 (Top)	3 ⁵ / ₈ " (92mm)	—	—	—	—
3349A 3549A	249 (Top) 349 (Bottom)	2 ¹ / ₂ " (64mm)	249 (Top) 349 (Bottom)	1 ³ / ₄ " (44mm)	—	—	—	—
3349A-F 3549A-F	—	—	249 (Top) 349 (Bottom)	3 ¹ / ₂ " (89mm)	—	—	—	—
3349A-LBL 3549A-LBL	249 (Top)	2 ¹ / ₂ " (64mm)	249 (Top)	2 ¹ / ₂ " (64mm)	—	—	—	—
3349A-LBL-F 3549A-LBL-F	—	—	249 (Top)	3 ⁵ / ₈ " (92mm)	—	—	—	—

33A/35A Strike/Stile information

Strikes for rim devices

299

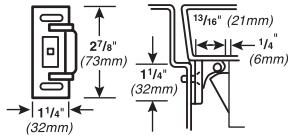

Projection 13/16" (21mm)

1408

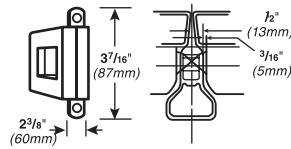

One per pair of doors - use with 5754 Mullion only

1410 - Integral stop

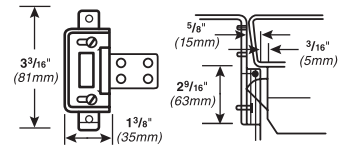

Projection 1/2" (13mm)

1439

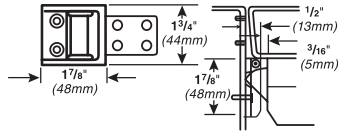

Projection 1/2" (13mm)

1606

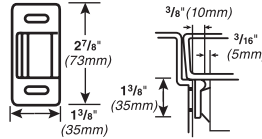

Projection 3/8" (10mm)

1609

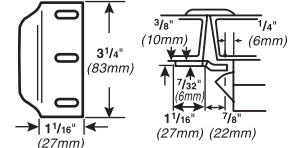

For rim/vertical rod combination -not fire rated

Strikes for vertical cable devices

249 - Top strike

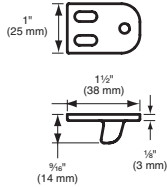

Projection 9/16" (14mm)

349 - Bottom strike

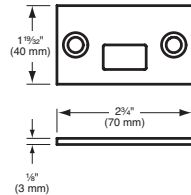

Projection 1/8" (3mm)

Strikes for vertical rod devices

260U-Flush transom only

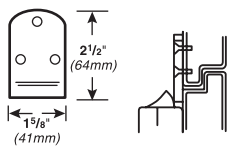

Projection 3/8" (10mm)

266

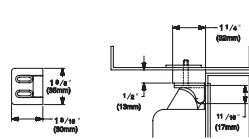

Projection 1 1/4" (32mm)

299

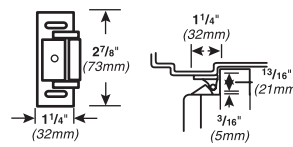

Projection 13/16" (21mm)

299F

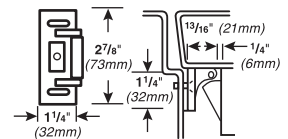

Projection 13/16" (21mm)

304L

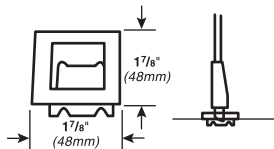

Mortise 13/16" (21mm)

338

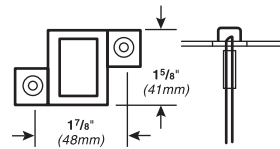

Mortise 5/8" (16mm)

385A

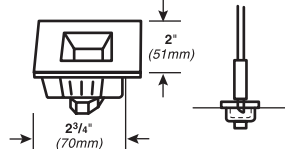

Mortise 2 1/2" (64mm)

499F

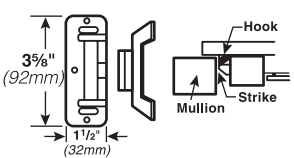

Projection 13/16" (21mm)

Grade, type and function options

ANSI function, grade & type

Function	Grade 1, type 4	Grade 1, type 5	Grade 1, type 6, 7 & 8	
01	33AEO 35AEO	3327A-EO 3327A-EO-F 3527A-EO 3527A-EO-F	3347A-EO 3347A-EO-F 3348A-EO 3348A-EO-F 3349A-EO 3349A-EO-F	3547A-EO 3547A-EO-F 3548A-EO 3548A-EO-F 3549A-EO 3549A-EO-F
02	33A-DT 35A-DT	3327A-DT 3527A-DT	3347A-DT 3348A-DT 3349A-DT	3547A-DT 3548A-DT 3549A-DT
03	33A-NL 33A-NL-OP 35A-NL 35A-NL-OP	3327A-NL-OP 3527A-NL-OP 3327A-NL-OP-F 3527A-NL-OP-F 3527A-NL 3327A-NL-F 3527A-NL 3527A-NL-F	3347A-NL-OP 3347A-NL-OP-F 3348A-NL-OP 3348A-NL-OP-F 3347A-NL 3347-NL-F 3348-NL 3348-NL-F 3349A-NL-OP 3349A-NL-OP-F 3349A-NL 3349A-NL-F	3547A-NL-OP 3547A-NL-OP-F 3548A-NL-OP 3548A-NL-OP-F 3547A-NL 3547-NL-F 3548-NL 3548-NL-F 3549A-NL-OP 3549A-NL-OP-F 3549A-NL 3549A-NL-F
08-09	33A-L 35A-L	3327A-L 3327A-L-F 3527A-L 3527A-L-F	3347A-L 3347A-L-F 3348A-L 3348A-L-F 3349A-L 3349A-L-F	3547A-L 3547A-L-F 3548A-L 3548A-L-F 3549A-L 3549A-L-F
11-12	33A-TL 35A-TL	3327A-TL 3327A-TL-F 3527A-TL 3527A-TL-F	3347A-TL 3347A-TL-F 3348A-TL 3348A-TL-F	3547A-TL 3547A-TL-F 3548A-TL 3548A-TL-F

Dimensions

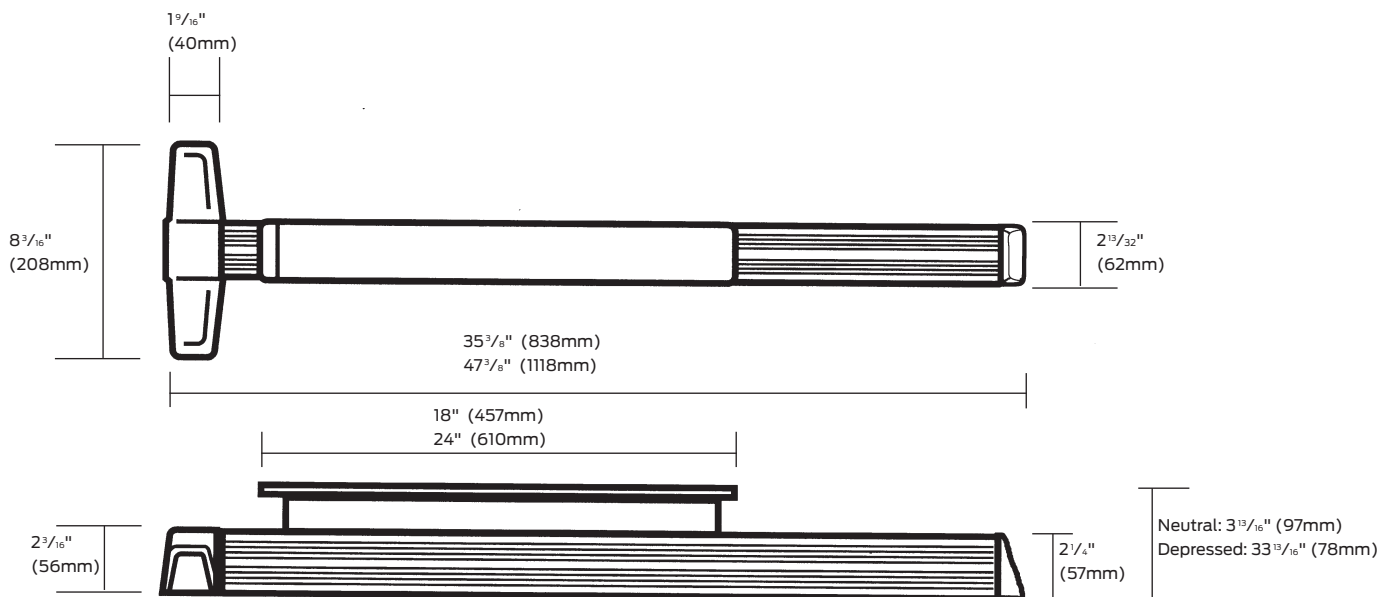

33A/35A Electrical options

ALK Alarm kit

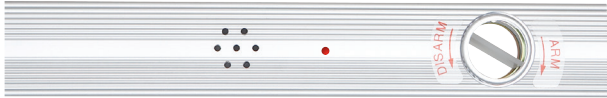

The ALK battery alarm kit is a simple yet effective way to deter unauthorized use of an opening. While the exit device is still a means of egress, the ALK kit contains an internal horn. When the touch bar is depressed, the horn sounds to provide an audible means of signaling that the opening has been violated. The alarm kit can be armed or disarmed by key. Thus allowing the exit device to be set in an armed or disarmed mode. The horn is rated at 85 decibel.

The key switch uses a standard 1 1/4" (32mm) mortise cylinder with a straight cam (Schlage Cam reference B502-191). The unit operates on one standard 9-volt alkaline battery. When the battery is weak, the horn will emit an intermittent low battery alert signal.

Also can be powered using the PS902 power supply. See PS902 for additional information. Alarm kits are available with a choice of two switch kits, RX or LX. RX monitors the touchpad and is furnished standard. LX optional latch bolt monitoring is recommended for use with surface vertical rod exit devices. Specify ALK-LX.

The ALK is available in two styles, 33A ALK, grooved cover and 35A ALK, smooth cover.

The ALK includes "EMERGENCY EXIT ONLY. ALARM WILL SOUND" decal for application on door, or the RSS push bar trim can be used instead of the door decal, specify RSS push bar trim.

The External Inhibit comes standard on Von Duprin exit devices. External Inhibit (EI) allows for the use of external switch to be used to arm, disarm and reset the alarm. Auto Reset (AR) is an option that rearms the alarm after a preset time. AR is available in three field selectable times – 1 1/2, 3 or 4 1/2 minutes.

When the ALK is used, standard dogging is removed. If cylinder dogging is required for 3' or 4' doors the ALK can be moved to the hinge side of the device and standard cylinder dogging can be added.

To order, specify:

1. Standard, 33A ALK
2. Cylinder Dogging, CD33A ALK

Minimum door sizes

Device	3' (914mm) Length	4' (1219mm) Length
33A/35A	2'9" (838mm)	3'3" (991mm)
3327A/3527A	2'8" (813mm)	3'2" (966mm)
3347A/3347A-F 3547A/3547A-F	2'8" (813mm)	3'2" (966mm)
3348A/3348A-F 3548A/3548A-F	2'8" (813mm)	3'2" (966mm)

RX Request to exit



The RX feature is used to signal the use of an opening. This device is equipped with one internal SPDT switch which monitors the pushpad.

The device can be connected to a security console, or may be used as a single door alarm when used with a horn and power supply. A continuous current electric transfer must be used for transferring power from the frame to the door.

The RX switch option should not be used to control a load, but as a signalling switch (0.5 amps. resistive maximum). The RX switch is available in a low current (LC) switch. Most commonly used in computer operated monitoring systems.

To order, specify:

1. Standard – Use prefix RX, example RX33AEO
2. Low Current – Use prefix RX-LC, example RX-LC35AEO

RX2 Double request to exit

The RX2 feature uses 2 RX switches.

To order, specify:

1. Standard – Use prefix RX2, example RX233AEO

LX Latch Bolt monitoring

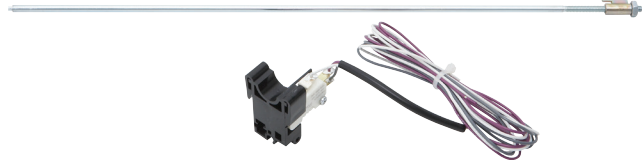

The LX feature is used to signal the use of an opening. This device is equipped with one internal SPDT switch which monitors the latch bolt. The device can be connected to a security console, or may be used as a single door alarm when used with a horn and power supply. A continuous current electric transfer must be used for transferring power from the frame to the door.

The LX switch option should not be used to control a load, but as a signalling switch (0.5 amps. resistive maximum).

The LX switch is available in a low current (LC) switch. Most commonly used in computer operated monitoring systems.

To order, specify:

1. Standard – Use prefix LX, example LX33AEO
2. Low Current – Use prefix LX-LC, example LX-LC35AEO

Electrical rating for all switches:

- Standard – 2 Amp maximum @ 24VDC
- Low Current (LC) - below 50 Milliamps @ 24VDC

Note: All switches can be either factory or field installed

33A/35A Chexit device

CX The Chexit® (with motor driven blocking actuator)*

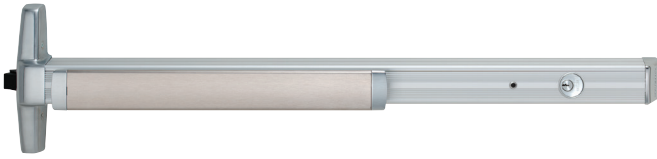

The Von Duprin Chexit device is designed for controlled egress applications. It meets both life safety and security needs, as well as the requirements of NFPA 101 for "Special Locking Arrangement" and IBC "Special Egress-Control Devices". All control inputs, auxiliary locking, local alarm and remote signaling outputs are self-contained in the Chexit assembly. Numerous configurable options allow the device to be customized for the specific code or application requirements. The standard Chexit device sounds an alarm and keeps the door secured for 15 seconds following an exit attempt with immediate release upon fire.

The Chexit device includes a 6" x 20" decal for application on door.

"PUSH UNTIL ALARM SOUNDS.
DOOR CAN BE OPENED IN 15 SECONDS"

Chexit typical applications

Chexit single door with options – The Chexit is used as an access control device. The card reader allows access. Also shown in this application is an external horn and door position switch. The auxiliary horn is used for increased volume in remote locations. Using a door position switch gives added security to the opening in case the door is not reclosed.

With the Chexit disarmed, the opening functions as a normal exit device. If card readers are required on both sides of the door, the normally closed contacts of the readers should be wired in series.

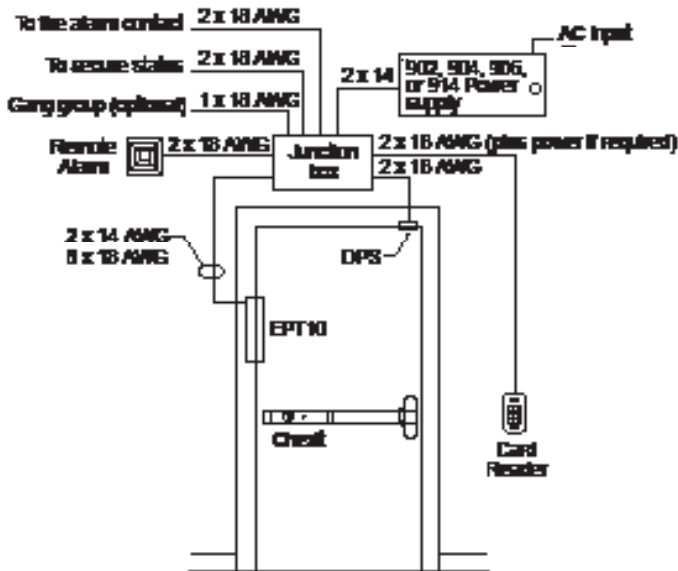

Figure 1. Riser Diagram, Single Door

Minimum door opening sizes for CX devices

Consult factory for other size requirements.

Device	3' (914mm) Length	4' (1219mm) Length
CX33A/35A	2'10 ³ / ₄ " (883mm)	3'4 ³ / ₄ " (1035mm)
CX3327A/3327A-F/3527A/3527A-F	2'10 ¹ / ₄ " (870mm)	3'4 ¹ / ₄ " (1022mm)
CX3347A/3347A-F/3547A/3547A-F	2'10 ¹ / ₄ " (870mm)	3'4 ¹ / ₄ " (1022mm)
CX3348A/3348A-F/3548A/3548A-F	2'10 ¹ / ₄ " (870mm)	3'4 ¹ / ₄ " (1022mm)
CX3349A/3349A-F/3549A/3549A-F	2'10 ¹ / ₄ " (870mm)	3'4 ¹ / ₄ " (1022mm)
CX3350/3350WDC-F/ 3550/3550WDC-F	2'10 ¹ / ₄ " (870mm)	3'4 ¹ / ₄ " (1022mm)

Specifications / Power supply requirements*

Input voltage – 24VDC

Input current inrush – 1.25A

Input current holding – 390mA

Alarm relay and Secure relay contact ratings – 24VDC, 1A

Fire alarm, Inhibit and Door position switch inputs require normally closed dry contacts.

Power supply information for CX devices with motor driven blocking actuator*.

Power supply	Maximum number of devices
PS902 (up to 2 amps)	1 Chexit device
PS904 (up to 4 amps)	3 Chexit devices
PS906 (up to 6 amps)	4 Chexit devices
PS914 (up to 4 amps)	4 Chexit devices

When powering multiple components, verify that the amperage requirements of all components combined does not exceed the power supply output rating, see table above for output ratings. Consult Installation Instructions for proper wire gauge and wire run requirements. Exceeding the recommended devices and/or not following Installation Instructions may void your warranty. Call Customer Care at 877-671-7011 or visit the Allegion website for more information - www.us.allegion.com.

How to order*

To order, specify:

1. Prefix product description number "CX".
Example: CX33A-L
2. Specify option (see options on page 38).
Example: CX-RCM
3. Door size other than 3' (914mm).
4. Door thickness other than 1³/₄" (45mm).
5. Finish.

*Note: Chexit devices built after August 24, 2015 are built using motor driven blocking actuators that have decreased power supply and operating requirements. The information listed in this catalog references the power supply and operating requirements that are needed for the new products with motor driven blocking actuators. For information on devices built previous to August 24, 2015, please contact Customer Care at 877-671-7011.

33/35 Chexit, RCM and DE5300 features

The Chexit, Remote Chexit Module (RCM) or DE5300 devices have several features and options available to fit your applications. See below for more information.

Inputs & Outputs

Fire Alarm Input

This input releases the door immediately upon a fire alarm allowing immediate egress. The Internal Alarm can be silenced during a fire input via an onboard switch setting.

Inhibit Input (Access Control)

This optional input is provided to allow authorized egress or entry when the device is Armed using an external card reader, Key Switch, etc. It also allows remote reset of the Chexit, RCM or DE5300 in an alarmed condition. The ability to reset alarms with the inhibit input can be disabled via an onboard switch setting.

Door Position Switch Input

An optional Door Position Switch (DPS) can provide door position status to Chexit, RCM or DE5300 for additional security, ensuring that the door is closed, and can cause alarm when the door is left or forced open.

Gang Bus

The Gang bus allows a Chexit, RCM or DE5300 device to signal other Chexit, RCM or DE5300 devices when it enters the Release Delay, allowing multiple doors to release at the same time in an emergency. Up to 8 devices may be connected to the Gang Bus.

Alarm Relay Contacts

The Alarm Relay contacts are provided as a means to control a Remote Alarm, such as a horn or lamp, or signal an external monitor. The contacts can be configured with a jumper as Normally Open or Normally Closed, and become active upon entering an alarmed condition.

Secure Relay Contacts

The Secure Relay contacts are provided as a means to signal an external monitor. The contacts can be configured as Normally Open or Normally Closed with a jumper, and become active when the DPS indicates the door is closed and the Push Pad is locked.

Delays

Release Delay

When the Push Pad is pushed and the Nuisance Delay expires, the Chexit, RCM or DE5300 enters the Release Delay with alarm. During the Release Delay, the Internal Alarm sounds, the Alarm Relay activates, and the Chexit/RCM keeps the Push Pad or DE5300 magnetic lock, locked for 15 seconds (less any time already elapsed during the Nuisance Delay). Once started, the Release Delay sequence will not stop and the devices will unlock.

Nuisance Delay

When a Chexit, RCM or DE5300 is located in a public area, it can be desirable to limit false releases when the Push Pad is accidentally pushed. The Nuisance Delay is the brief time a Push Pad can be accidentally pushed before the Release Delay sequence starts. If the Nuisance Time is set to 0 seconds the Chexit, RCM or DE5300 will enter Release Delay as soon as the Push Pad is pushed (when armed). Setting the Nuisance Time to 1, 2, or 3 seconds allows the Push Pad to be pressed for 1 to 3 seconds before the Chexit, RCM or DE5300 goes into Release Delay. If the Nuisance Audio and Nuisance Delay are both on, the Internal Alarm will pulse during the Nuisance Delay. The Alarm Relay does not activate during the Nuisance Delay. If the Push Pad is released before the Nuisance Delay expires, the Chexit, RCM or DE5300 will remain armed.

Rearm Delay

The Rearm Delay is the amount of time after the Key Switch or Inhibit Input is deactivated to when the device rearms. It is designed to give someone time to pass through the door before rearming occurs. The Rearm Time can be changed via the onboard switch settings from 0 and 28 seconds in 2 second increments. If the Rearm Time is set to 30 seconds and a DPS is used, if the door is opened and the Rearm Time expires, there will be no alarm. The Chexit, RCM or DE5300 will rearm after the door is closed. If the door never opens, the Chexit, RCM or DE5300 will rearm after 30 seconds. If not using a DPS, the Chexit, RCM or DE5300 will always rearm in 30 seconds.

DPS Delay

If the DPS detects that the door closed during the Rearm Delay, the Chexit, RCM or DE5300 ends the Rearm Delay and allows 2 seconds for the latch to clear the strike before rearming.

Interface

Key Switch

The Key Switch provides the means to Arm or Disarm/Reset the Chexit, RCM or DE5300. Turning the Key Switch clockwise initiates the Rearm Delay, and turning the Key Switch counter-clockwise Disarms/Resets the Chexit, RCM or DE5300. The Key Switch allows the key to be removed in either the Arm or the Disarm/Reset position.

Status Indicator

The red Status Indicator displays the status of the Chexit, RCM or DE5300. The Status Indicator flashes slow if the Chexit, RCM or DE5300 is armed, flashes fast in an alarmed mode, is off when inhibited and on solid during Rearm Delay.

Internal Alarm

The Internal Alarm sounds the status of the Chexit, RCM or DE5300. The Internal Alarm sounds continuously during and after a fire alarm or a Release Delay, pulses fast during the Nuisance Delay or a tamper and pulses slow during Disarmed Powerup mode.

Settings

Armed Powerup

When set to OFF, a power disruption and power return will put the Chexit, RCM or DE5300 in a disarmed, unlocked alarm mode.

Trim Fail Safe / Fail Secure (FS/FSE)

The trim input power can be set to FS (Fail Safe; locked when energized, unlocked when deenergized or during power failure) or FSE (Fail Secure; unlocked when energized, locked when deenergized or during power failure).

The trim must be bought or modified to physically function as FS or FSE. This on board setting only selects the trim input power.

33A/35A Chexit options

RCM Remote Chexit Module — is designed to provide the concept of the Chexit delayed exit system for door sizes smaller than the standard Chexit device can accommodate. The Chexit module is installed in a control box and mounted in a remote location. Features and functions of the standard Chexit exit device are available on the Remote Chexit Module.



RCM Module

Minimum door opening sizes for RCM devices

Consult factory for other size requirements.

Device	3' (914mm) Length	4' (1219mm) Length
CX-RCM33A/35A	2'5" (737mm)	2'11" (889mm)
CX-RCM3327A/3327A-F /3527A/3527A-F	2'4½" (724mm)	2'10½" (876mm)
CX-RCM3347A/3347A-F /3547A/3547A-F	2'4½" (724mm)	2'10½" (876mm)
CX-RCM3348A/3348A-F /3548A/3548A-F	2'4½" (724mm)	2'10½" (876mm)
CX-RCM3349A/3349A-F /3549A/3549A-F	2'4½" (724mm)	2'10½" (876mm)
CX3350/3350WDC-F /3550/3550WDC-F	2'4½" (724mm)	2'10½" (876mm)

Specifications / Power supply requirements*

Size – 3.75" x 5.57" x 2.50"

Input voltage – 24VDC

Input current inrush – 1.25A

Input current holding – 390mA

Alarm relay and Secure relay contact ratings – 24VDC, 1A

Fire alarm, Inhibit and Door position switch inputs require normally closed dry contacts.

Cylinders — Cylinders are not furnished with the Chexit device and must be specified when ordering. Use 1¼" mortise cylinder with compression ring K510-406 with straight cam and orient cam as shown. Schlage cylinder 20-001-114 recommended for the device and the CD cylinder dogging option. See Schlage Pricebook for additional information.

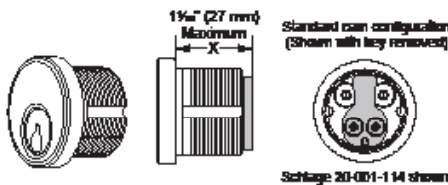

How to order*

See Chexit "How to order" on page 36.

*Note: RCM modules built after August 24, 2015 are built using motor driven blocking actuators that have decreased power supply and operating requirements. The information listed in this catalog references the power supply and operating requirements that are needed for the new products with motor driven blocking actuators. For information on devices built previous to August 24, 2015, please contact Customer Care at 877-671-7011.

DE5300 Delayed Egress System

DE5300 Delayed Egress System — is designed for controlled egress applications when used in conjunction with a magnetic lock. It meets both life safety and security needs, as well as the requirements of NFPA for "Special Locking Arrangement" and IBC "Special Egress-Control Devices". All control units, auxiliary locking, local alarm and remote signaling outputs are self-contained in the DE5300 assembly.



DE5300 Module

The DE5300 is commonly used on narrow stile doors where a standard or narrow stile Chexit is not practical. DE5300 Delayed Exit System uses a Chexit logic board and a Von Duprin RX-LC (low current request to exit) panic device to control a Schlage Electronics Direct Hold Magnetic Lock.

The Chexit module for the DE5300 is installed in a control box and mounted in the wall adjacent to the door. Features and functions of the standard Chexit exit device are available on the DE5300.

The DE5300 device includes a 6" x 20" decal for application on door.

"PUSH UNTIL ALARM SOUNDS.
DOOR CAN BE OPENED IN 15 SECONDS"

Cylinders — Cylinders are not furnished with the DE5300 and must be specified when ordering. Use 1¼" mortise cylinder with compression ring K510-406 with straight cam and orient cam as shown. Schlage cylinder 20-001-114 recommended for the device and the CD cylinder dogging option. See Schlage Pricebook for additional information.

Specifications / Power supply requirements

Size - 3.75" x 5.57" x 2.50"

Input voltage – 24VDC

Input current – 1A

Alarm relay and Secure relay contact ratings – 24VDC, 1A

Fire alarm, Inhibit and Door position switch inputs require normally closed dry contacts.

How to order

To order, specify:

- DE5300
- M420/P, M450/P, or M490/P magnetic lock (order direct from Schlage Electronics).
- RX-LC 22/33A/35A/98/99 device.
- PS900 Series
- EPT-2/10

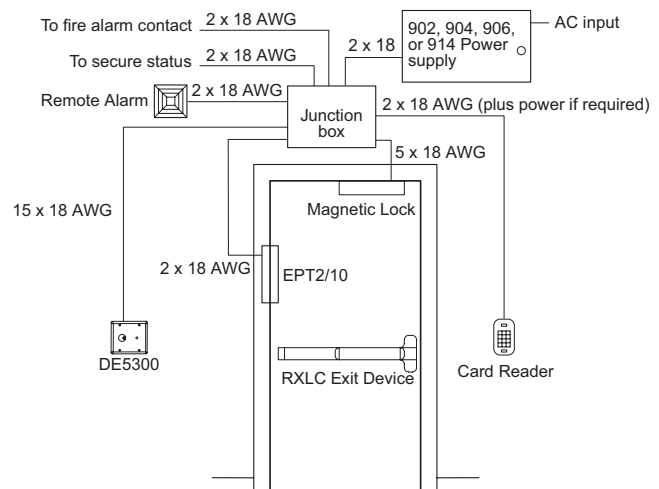

Figure 1. Riser Diagram, Single Door

33A/35A Electrical options

QEL Quiet electric latch retraction

The QEL feature allows for the remote unlatching of exit devices. A control station operator can flip a switch to retract the latch bolt and immediately change an exit door to push-pull operation. Different than the popular EL, the QEL quiet operation is achieved using an electric drive motor which retracts the latch bolt either momentary unlatching or for extended periods of time. This feature is an alternative to manual dogging.

QEL devices are also useful with automatic door operators, and may be applied to fire-rated applications when under the control of an **automatic fire alarm system**.

UL approved for Class II circuit applications.

The QEL option does not include the power transfer from door to frame, the power supply, or the control operator. Refer to EPT-2 power transfer and the PS902 or 914 power supply.

The PS902/914 with the 2RS, 4RL or 4R board is the minimum required. Other option boards available for other functions, see PS902/914 power supply for additional information.

QEL Electrical load	
Voltage	24VDC
Current	1.0 A Inrush (0.5 sec.) 0.14 A Holding 2.0 A Calibrate (3 sec. one time)

To order, specify:

- Standard – Use prefix QEL, example QEL33A-L.

Popular QEL application

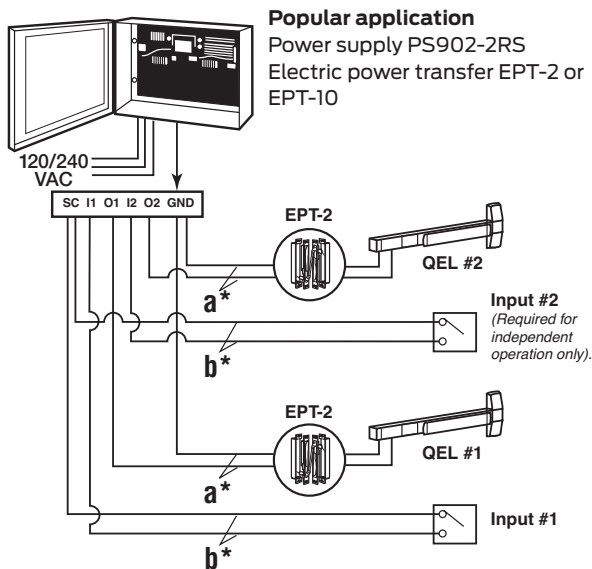

QEL Device wire selection size

a*	Distance (one-way)	Wire Gauge
	200 ft.	18 AWG
	320 ft.	16 AWG
	500 ft.	14 AWG
	800 ft.	12 AWG

b*	Wire selection	Switch wire size
	1200 ft. Max.	18 gauge standard

EL Electric latch retraction

The EL feature allows for the remote unlatching of exit devices. A control station operator can flip a switch to retract the latch bolt and immediately change an exit door to push-pull operation. A powerful, continuous duty solenoid retracts the latch bolt, either for momentary unlatching, or for extended periods of time. The EL feature is an alternative to manual dogging. If manual hex-key dogging is required, specify HD-EL.

EL devices are also useful with automatic door operators, and may be applied to fire-rated applications when under the control of an **automatic fire alarm system**. UL approved for Class II circuit applications.

The EL option does not include the power transfer from door to frame, the power supply, or the control operator. Refer to EPT-2 power transfer and the PS914 power supply.

The PS914 with the 900-2RS option card is minimum option card required. Other option cards available for other functions, see PS914 power supply for additional information.

Solenoid specifications:

Continuous Duty – 24 VDC
Current Inrush – 16 Amps
Current Holding – 0.3 Amps

To order, specify:

- Standard – Use prefix EL, example EL33AL
- Hex Key dogging – Use prefix HD-EL, example HD-EL33AL

Popular EL application

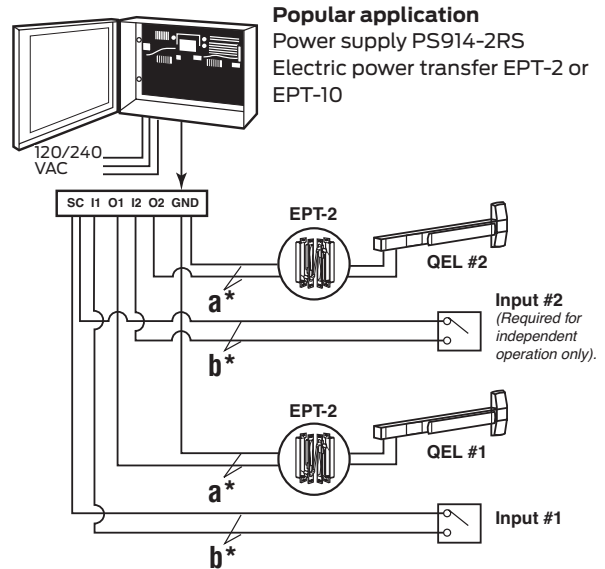

EL Device wire selection size

	Von Duprin exit device	EL Wire length (feet) ¹	Wire gauge (AWG)
	EL 33A/35A Rim	0-500	12
		0-300	14
		0-200	16
a*	All other EL33A/35A device types	0-250	12
		0-150	14
		0-100	16
b*	Control Switch	0-1200	18

1. Wire lengths include an EPT, Door loop, electric hinge or pivot and are measured one way between the PS914/option board and the device.

2. Table is applicable to devices that have shipped after August 2012.

33A/35A Electrical accessories

Power supplies

Series PS902/914



Overview:

The PS900 Series is a consolidated line of power supplies and accessories that offer enhanced flexibility and functionality specific to the changing needs of the access control market. The PS900 Series can be used in a variety of applications to convert high voltage AC power into the low voltage DC outputs required by most access control devices. The PS900 Series protects devices downstream by providing Class 2*, filtered and regulated power. The full line is UL294 certified.

Note: PS906 can provide Class 2 rated outputs when used with 900-8P distribution board.

Features:

- Constant output rating at both 12 VDC and 24 VDC provides superior performance ; includes field selectable jumper
- Polarized connectors for option boards eliminate need for racks and side connectors
- Flat mounting of option boards provides easier access to terminal blocks for connection of electrified devices
- High voltage protective cover
- Battery back-up board auto-selects voltage
- Fire alarm relay can be configured to provide either switched or un-switched outputs from a power supply
- PS914 designed with high in rush current for powering electrified panic devices
- Universal 120-240 VAC input
- Low voltage DC, regulated and filtered
- Electronic power limiting foldback circuit for AC current overload protection
- Fused primary input
- AC status monitor- isolated SPDT contacts
- AC input and DC output LED status indicators
- Cover mounted AC input indication
- Hinged cover with lock down screws

Certifications:

- UL 294 certified—the standard for access control
- Class 2 rated*

* Except PS906, output rating exceeds Class 2 power limits

Once power is converted to low voltage DC, the PS900 Series offers a variety of distribution options, including basic fuse protection, simple relay, and advanced logic providing complex sequencing and timing functions.

* PS906 can provide Class 2 rated outputs when used with 900-8P distribution board.

	PS902	PS904	PS906	PS914
Number of connectors on power supply for the following:	2 amps	4 amps	6 amps	4 amps
Distribution boards	1	2	3	2
Battery back-up board	1	1	1	1

Note: One fire alarm board can be connected directly to the PS902. If a fire alarm board is desired for the PS904, PS906 or PS914 it can be connected to a distribution board.

Applications:

The PS900 Series of power supplies works with many electrified devices including Schlage electromagnetic locks, Schlage AD-Series hardwired locks, Schlage electrified mechanical locks, Von Duprin electrified strikes , Von Duprin exit devices, and many other brands.

Accessories:

The Schlage PS900 Series features seven option boards for use in a variety of applications. All Schlage PS900 Series power supplies option boards are UL 294 certified.

Option boards:

900-4R: 4 relay controlled output board to power multiple devices

900-4RL: 4 relay distribution board with logic is field configurable for time delay function, auto operator, security interlock

900-8F: Provides 8 individually fuse-protected outputs, giving the flexibility to power multiple devices and provide another layer of protection

900-FA: Emergency interface relay integrates with fire alarm and is used to cut power in case of emergency

900-BB: Battery backup

900-2RS: 2 relay EL/QEL panic device control board (PS914 only)

900-BBK: Battery backup kit includes two 7A/hr batteries and provides up to four hours of backup power when cycled every 5 minutes at full load

33A/35A Electrical accessories

EPT Electrical power transfer PNT Pneumatic transfer

Electric power transfer provides a means of transferring electrical power from a door frame to the edge of a swinging door. The units are completely concealed when the door is in the closed position, and are ideally suited for installations involving abuse or heavy traffic.

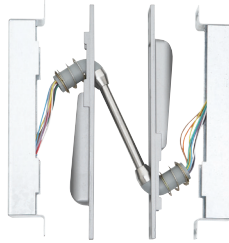

Two models are available; EPT-2, two 18 gauge wires and EPT-10, ten 24 gauge wires. The EPT-2 and EPT-10 are U/L listed as "miscellaneous door accessory".

Pneumatic controls

PNT-1 is available for pneumatic latch retraction exit devices. Appearance and dimensions are identical to EPT models.

UL Listed for use on fire doors

Door applications:

Degree of opening	Hinge type	Door thickness
0-180	Up to 5" butt hinges	1 3/4"
0-180	Up to 3/4" offset pivots	1 3/4"
0-130	5 1/2" butt hinges	1 3/4"
0-110	6" butt hinges	1 3/4"
0-90	Swing clear hinges	1 3/4"

Finishes

SP28 (sprayed aluminum)

SP313 (sprayed duranodic).

Dimensions

Housing	9" x 1 1/4" x 1 5/8" (229mm x 32mm x 38mm)
EPT-2	Two 18 gauge wires, Up to 2 AMPS @ 24VDC, with a 16 AMPS Maximum Surge
EPT-10	Ten 24 gauge wires, Up to 1 AMPS @ 24VDC, with a 16 AMPS Maximum Surge
PNT-1	5/32" Tubing

To order, specify:

1. EPT-2, EPT-10 or PNT-1.
2. Finish, SP28 or SP313.

Allegion Connect

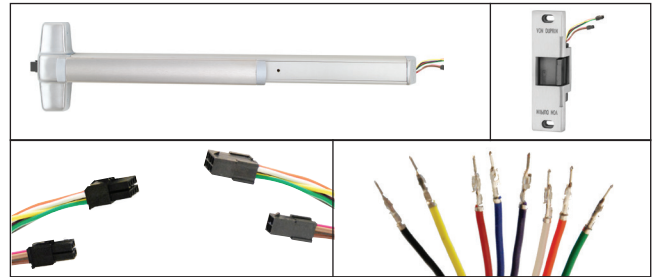

Allegion's cross-category Connect features common interconnect components to our electrified options. Allegion Connect is a quick and easy way to connect power sources; all the way from your power supply to locking device. There is no wire cutting; reducing installation and maintenance time ultimately cutting cost. After installation, Allegion's Connect continues to provide benefits throughout the lifetime of the opening by offering a service kit for repairs or modifications in the future.

Features and benefits

- Quick: common connections reducing installation time
- Perfect Connections: these factory installed connectors ensure the right wires match up every time
- Protective: the connectors protect the connection points throughout the installation process and lifetime of the opening
- Interchangeable: all Allegion Connect products utilize the same connectors
- Maintenance: you no longer need to cut away wire to disconnect Allegion products, also available is a service kit specifically for Connect products.

Harness length	Connectors on both ends	Connectors on one end, crimped pins on the other end
6 Inches	CON-6	CON-6P
12 Inches	CON-12	CON-12P
26 Inches	CON-26	CON-26P
32 Inches	CON-32	CON-32P
38 Inches	CON-38	CON-38P
44 Inches	CON-44	CON-44P
50 Inches	CON-50	CON-50P
192 Inches	CON-192	CON-192P

Power Supply Wire Harness = Connectors on one end, stripped leads on the other end, offering a direct connection to the power supply

6 Inches	CON-6W - wire extension to power supply
----------	---

Consult door manufacturer for harness length requirements.

Note: You will need to purchase a separate wiring harness to go from exit device to hinge/EPT and an additional harness to go from hinge/EPT to power supply or access control system. Harness part numbers with ordering information can be located in the Schlage, Von Duprin and Falcon pricebooks. A service kit is available for order in the Schlage, Von Duprin and Falcon pricebooks. Included in this kit are male end plugs, female end plugs and pins to customize harnesses to your application.

Note: Must be ordered with exit devices and locks

How to order

1. Specify CON for Connect electronic options
Example: EL-35-EO-CON (35 Series Electrified Latching exit only with Connect connectors)
2. Specify harness length; Consult door manufacturer for harness length
3. Specify Von Duprin EPT10-CON or Ives 7200 power transfer hinge

Wire run options

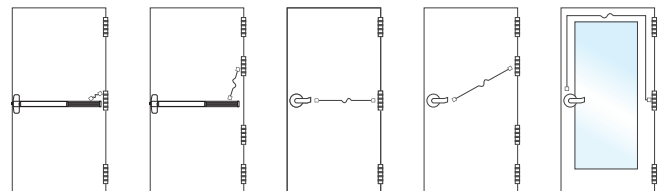

33A/35A Mechanical options

AX Accessible device

The AX device is a UL certified exit device designed to meet the progressive requirements of the California Building Code for accessible openings. This device meets the 5 lbs of operating force requirement called for in chapter 11B-309.4. The AX device also exceeds ANSI/BHMA requirements. Available devices include: AX33/35A, AX33/35A-F, AX33/3549A LBL, AX33/3549A-F LBL, AX33/3549A-F LBLAFL. Additionally, all AX devices will be shipped with a new UL label clearly stating "Meets California Building Code (2013) Sec. 11B-309.4" and an "AX" identifier label on device center case. See images below for reference.

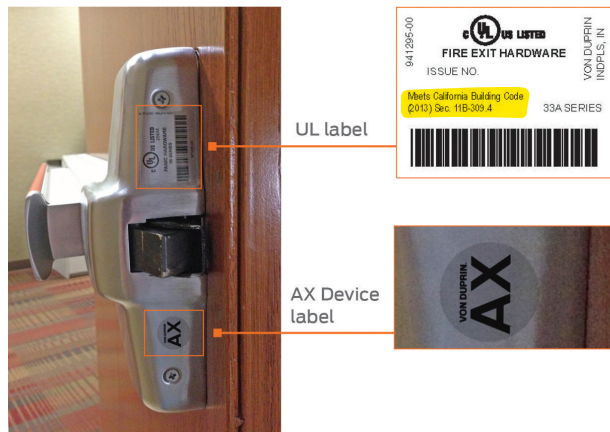

PN Pneumatic controlled exit devices



The PN feature provides remote latch bolt retraction in hazardous areas where electrically operated devices would not be permitted. The pneumatic solenoid will retract the latch bolt for momentary or prolonged periods. PN exit devices are particularly suited for use with automatic door operators. The PN feature is available on both Panic and fire exit hardware devices.

The PN feature includes a special actuating linkage that gives building owners the option of mechanically or pneumatically dogging the exit device. If manual hex-key dogging is required, specify HD-PN (Dogging the device, whether mechanically or pneumatically, makes the device function as a push/pull unit and reduces the wear on its moving parts.) If cylinder dogging is required, the standard cylinder dogging is not available.

When activated pneumatically, the latch bolt(s) of the exit device retract in 1/22 to 1/2 seconds. This pneumatic operation uses air pressure ranging from 50 to 100 pounds per square inch.

This product will function only when it is part of a pneumatic system (air compressor, air lines, pneumatic system, etc.).

Contact LCN for correct control boxes.

To order, specify:

- Standard — Use prefix PN, example PN99NL
- Hex Key Dogging — Use prefix HD-PN, example HD-PN33ANL
- Special Center Case Dogging (handing is required, specify RHR or LHR) — Use prefix SD-PN, example SD-PN33ANL

PNT pneumatic transfer

Pneumatic controls

PNT-1 is available for pneumatic latch retraction exit devices. Appearance and dimensions are identical to EPT models.

RSS Red Silk Screen



Red silkscreen lettering on touchpad trim. - "Emergency Exit Only, Push To Open And Sound Alarm". This comes standard on SS devices.

To order, specify: Suffix RSS, 3327L-RSS RHR

WH Weep holes

WH is available for all 98/99 Series exit devices. Weep holes are ideal for devices that are mounted to exterior doors that can be exposed to rain and other elements. Hole spacing on 3' and 4' devices are every 6" on center. A 3 foot device will have 5 holes, are 4 foot device will have 7 holes.

To order, specify: Suffix WH, 33A-EO-WH

SS Signal switch

Monitors pushpad and latch bolt

The SS feature is used to signal the unauthorized use of an opening. This device is

equipped with two internal SPDT switches. One switch monitors both the pushpad and the latch bolt assembly, making the latch bolt tamper resistant, for positive security. An additional SPDT switch is connected to the 1 1/4"

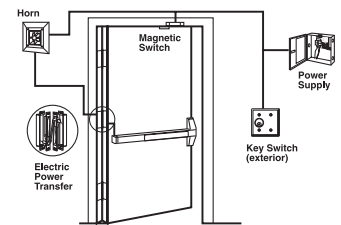

(32mm) mortise with straight

cam for alarm "bypass." (Schlage cam reference B502-191).

The device can be connected to a security console, or may be used as a single door alarm when used with a horn and power supply. A continuous current electric transfer must be used for transferring power from the frame to the door.

To order, specify:

1. Prefix SS, example SS33AL
2. Handing Required, LHR or RHR

Electrical ratings:

Up to 2.0 AMPS @ 24VDC

Popular SS application

Unauthorized use of this opening will activate the local horn. The key switch permits inhibiting this system for authorized entry.

SG Safety glow



Self-illuminating touchpad defines the location of the exit door in dark or smoke-filled area. The Safety Glow coating is a special powder coat finish that glows brightly during low or no light conditions. This coating was developed to meet MEA standards where luminescent exit door markings are required in commercial facilities. There are no batteries or electronics, the coating is charged when exposed to light.

To order, specify: Suffix SG, EL 3327A-SG

33A/35A Mechanical options

Dogging options

LD Less dogging

Less Dogging is available in all 33A/35A Panic Exit devices to remove the dogging option.

To order, specify: 1. Use prefix LD, example LD33AL

CD Cylinder dogging

Cylinder dogging is available on all 33A/35A Panic Exit devices to replace the standard hex key dogging. Unit requires a standard 1¹/₄" (32mm) mortise cylinder with a straight cam (Schlage Cam B502-191 reference).

To order, specify: 1. Use prefix, CD, example CD33AL

CDK Cylinder dogging kit

For field conversion, a cylinder dogging conversion kit is available. Cannot be added to fire exit hardware.

Order: 33A/99CDK or 35A/98CDK, specify finish



Dummy pushpad

The 330 dummy pushpad is designed as a companion unit for all 33A devices. The 350 dummy pushpad is a companion unit for all 35A devices. The pushpad is rigid or nonfunctioning. A push/pull operation can be accomplished by using 386DT, 360L-DT, 550DT, 392-6 trim or any Ives Pull.

The 330/350 can be equipped with a functional pushpad and will accommodate an RX switch. Specify RX-330. May also be equipped with the RX2, double RX switch. Specify RX2-330

To order, specify:

1. 330 or 350
2. Size 3' or 4' (914mm or 1219mm)
3. Finish, US3, US4, US10, US26, US26D, US28, 313AN, 315AN, 350 Only US32D.

33A/35A Device options & accessories

RG-27 Vertical rod and latch guard



Rod Guard

Latch Guard



Series RG-27 Vertical rod and latch guards protect the bottom rods of exit devices from the damaging impacts of carts or gurneys passing through doors. (If bottom rods become damaged, the exit device will not function as intended and can jeopardize the ability to exit safely during an emergency.)

In addition to protecting the vertical rod, the guard provides a smooth, unobstructed surface so the door can be pushed open easily with the bumpers of a wheelchair. The latch guard portion is 10" high. The standard latch guard features a 45° ramp. The extended latch guard offers a continuous ramp in 3' or 4' widths.

All stainless steel construction in US32D finish. Latch guards can cover latches as large as 1 1/4"W x 10"H x 1 7/8" projection.

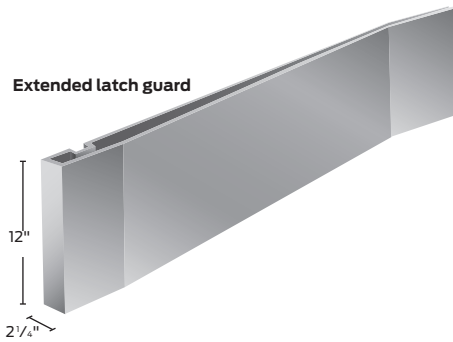

Models

RGO	Rod guard only (Projection 1 3/16")
RG-27	Rod and latch guard
RG-27-3	3' (914mm) Rod guard and extended latch guard
RG-27-4	4' (1219mm) Rod guard and extended latch guard
LGO	Latch guard only
LGO-3	3' (914mm) Extended latch guard only
LGO-4	4' (1219mm) Extended latch guard only

Note: Wood doors - Can be used on fire doors with high density blocking with sheet metal screws. For non-fire rated wood doors use sex bolt.

To order, specify:

1. Model number.
2. Handing (except on RGO).
3. Door material if other than Hollow metal.
4. Optional sex bolt mounting available.

LBR/LBL Less bottom rod/Less bottom latch

LBR/LBL option is available, using a spring loaded auxiliary latch bolt installed in the lower door edge. When exposed to heat the auxiliary latch bolt releases, keeping the doors in alignment and closed during a fire. UL listed 3 hours on hollow metal doors double egress, 90 minute swinging same direction, and 20 minutes wood doors (consult wood door manufacturer). Fits door stiles as narrow as 3 5/8".

LBR/LBL devices must be ordered in pairs or must be used in conjunction with an approved automatic or constant latching flush bolt.

LBR/LBL used on non-fire rated devices, the spring loaded auxiliary latch bolt is not required. Device is supplied less bottom rod, latch and strike.

PL Pullman latch

When PL is specified the standard latches are replaced with pullman style latches. Pullman latches are always extended and are most commonly used in conjunction with electric strikes and LBR-less bottom rod application. Not available with Fire rated devices. Not recommended where security is of the utmost since latches do not deadlock.

GBK Glass bead kit

Glass bead conversion kits are available for all 33A/35A Series devices for use on doors with raised glass beads. Each kit consists of 1/4" (6mm) shim sets. GBK for Surface vertical rod ships with 1/8" shims for rod guides.

To order, specify:

1. 33AGBK
2. Device type (Rim, mortise, surface vertical rod, concealed vertical rod)
3. Wood door, when used with concealed vertical rod

WDA Cover plate kit

For wood door applications, used to cover up door preparations for control, also prevents the control from boring into the wood door. Finished to match control.

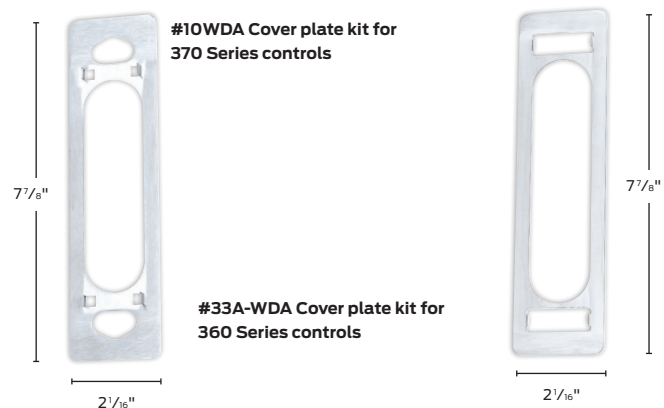

33A/35A Device options & accessories

Mullions

Removable steel mullions provide single door performance in double door openings with rim devices. Mullions are easily removed by loosening bottom set screw and removing top fitting cover. The top mullion fitting is attached to the frame and is concealed by the fitting cover.

Steel mullions are 2" (51mm) wide and 3" (76mm) deep, with a wall thickness of $\frac{1}{8}$ " (3mm).

Mullions are shipped with mounting screws and prepared for strikes. Strikes are not included except where indicated.

Steel mullions are available in SP28 and SP313 finishes. Consult factory for other powder coat finish options.

KR – Keyed removable steel mullions make removal faster and easier by a single operation of the mortise cylinder. Once mullion is removed, large equipment or furniture can freely pass through the opening. The unit will self lock when re-installed, without the use of the cylinder key. Uses a $1\frac{1}{4}$ " mortise cylinder with a straight cam (Schlage cam reference L583-475). Cylinders are sold separately. Prefix mullion model with "KR".

Removable aluminum mullions are $1\frac{1}{16}$ " (27mm) wide on face closest to the door and $2\frac{3}{8}$ " (60mm) at the widest point. The depth is $3\frac{1}{8}$ " (79mm) with a wall thickness of $\frac{1}{8}$ " (3mm).

Aluminum mullions are available in US4, US10, US28, 313 and 315 finishes. Consult factory for other powder coat finish options. Aluminum mullions are not available keyed removable.

Stock hollow metal applications for devices mounted to cover ANSI 161 cutouts are higher than the standard mullion strike location. Consult the factory for special strike preparation or order a blank mullion. See below.

Blank mullions are furnished without strike preparation. They are used to mount devices at a strike height different from the standard mullion preparation.

To order, specify:

1. For keyed Removable option on steel mullions, prefix model number with "KR"
2. Model number
3. Height of opening
4. Finish
5. Handing if required
6. Centerline deviation (refer to device template for standard centerline)
7. Strikes, when required, should be ordered with device

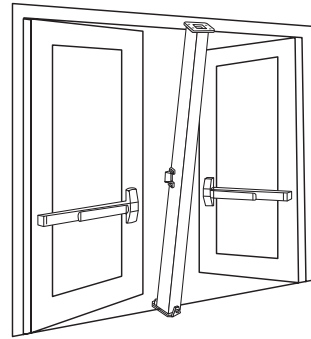

Removable mullions

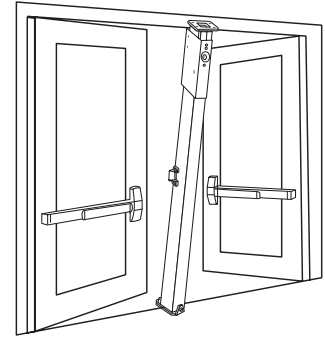

Keyed removable steel mullions

Steel mullions

1654 Prepared for two 1606 strikes. If 1606 strikes are not specified on the order, two per mullion will be added. Additional charges apply.

4954 Prepared for 264 or 299 strikes. For use with all Von Duprin Panic rim devices.



9954 Prepared for and must be used with two 268 strikes (88-F device), or two 499F (22-F, 33A-F, 35A-F, 98-F, 99F devices).

UL fire labeled mullion for up to 3 hour opening using Von Duprin fire exit rim devices. This mullion is not easily removed due to special fittings.

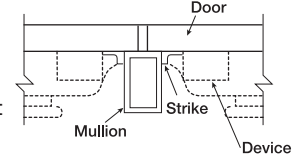

33A-F and 35A-F devices are rated up to 10'0" (3048 mm).

Note: If 268 or 499F strikes are not specified on the order, two per mullion will be added. Additional charges apply.

4754 Prepared for two 4263 monitor strikes.

4854 Prepared for one 299 and one 6111 electric strike. Indicate handing for electric strike.



9854 Prepared for one 268 or 499F strike and one 6111 electric strike. Indicate handing for electric strike. UL fire labeled mullion for up to 3 hour openings up to 8' x 8' (2438mm x 2438mm) using Von Duprin fire exit rim devices

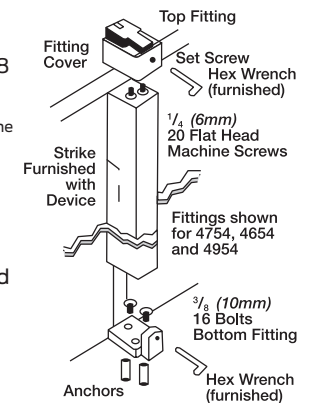

Aluminum mullions

5654 Prepared for two 299 strikes.

5754 Prepared for 1408 double strike.

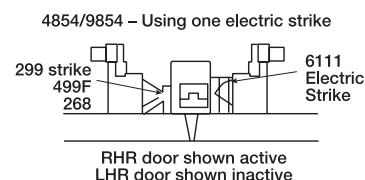

33A/35A Additional information

UL Listed — Fire exit hardware label/Opening size

Exit device	Single door	Double door	
		Same direction	Double egress
33A/35A-F	3 Hour 4' x 10'	3 Hour 8' x 8' (w/ KR98/9954 mullion) 3 Hour 8' x 10' (w/ 98/9954 mullion)	—
3327A-F	—	90 Min. 8' x 10'	3 Hour 8' x 10'
3527A-F	—	90 Min. 8' x 10'	3 Hour 8' x 10'
3347A-F	—	90 Min. 8' x 10'	3 Hour 8' x 10'
3547A-F	—	90 Min. 8' x 10'	3 Hour 8' x 10'
3348A-F	—	90 Min. 8' x 10'	3 Hour 8' x 10'
3548A-F	—	90 Min. 8' x 10'	3 Hour 8' x 10'
3349A-F	—	90 Min. 8' x 10'	3 Hour 8' x 10'
3549A-F	—	90 Min. 8' x 10'	3 Hour 8' x 10'

When using the 3347A-F and 3547A-F in a wood door application, consult wood door manufacturers for current UL listings.

Cylinders

Cylinders are not furnished with device or trim and must be specified when ordering. Refer to trim pages for cylinder type.



Mortise — 3215 (Schlage 20-001, B502-191 cam)



Rim — 3216 (Schlage 20-022 cam)

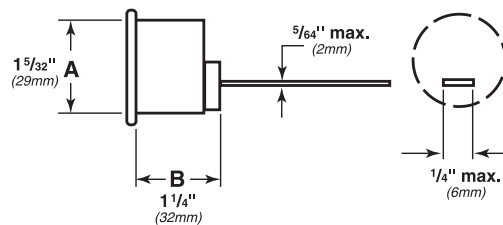
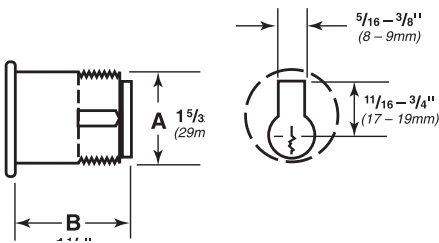

Dogged (inverted) cam

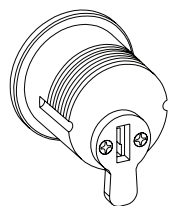

For cylinder dogging or 360L

Undogged cam (standard operations)

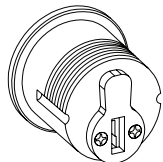

For standard trim functions or 360L-NL



33A/35A Finishes

Finishes*

	Color	US number	BHMA number
	Chromium, polished	US26	625
	Anodized, aluminum	US28	628
	Chromium, dull	US26D	626
	Brass, polished	US3	605
	Brass, dull	US4	606

	Color	US number	BHMA number
	Bronze, dull	US10	612
	Satin nickel Available for 35A ONLY	US15	619
	Satin stainless steel	US32D	630
	Duranodic dark bronze	313	710
	Black, painted (not flat powder)	SPBLK	693
	Flat Black	US19/ 315	622/711
	Aged bronze	–	643e

Special finishes

	Color	US number	BHMA number
	Satin chrome, Antimicrobial	US26D-AM	626-AM
	Satin stainless steel, antimicrobial	US32D-AM	630-AM

Pushpad Options — Knurled

Embossed “Push”

Braille (Caution-Stairwell), satin stainless steel only

RSS – (Emergency Exit – Push to open and sound alarm) – Red Silkscreen lettering on US32D

* NOTE: Durable powder coated finishes available at specific special request. PLEASE CONTACT FACTORY.

About Allegion

Allegion (NYSE: ALLE) is a global pioneer in safety and security, with leading brands like CISA®, Interflex®, LCN®, Schlage®, SimonsVoss® and Von Duprin®. Focusing on security around the door and adjacent areas, Allegion produces a range of solutions for homes, businesses, schools and other institutions. Allegion is a \$2 billion company, with products sold in almost 130 countries.

For more, visit www.allegion.com

aptiQ ■ LCN ■ **SCHLAGE** ■ STEELCRAFT ■ VON DUPRIN