

Architectural Door Accessories

ASSA ABLOY
Opening Solutions

The global leader in
door opening solutions

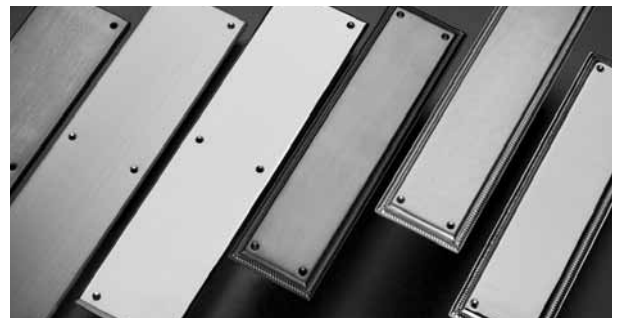
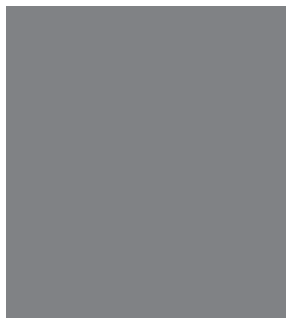
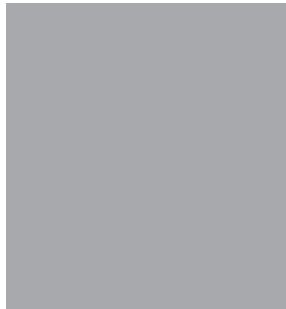
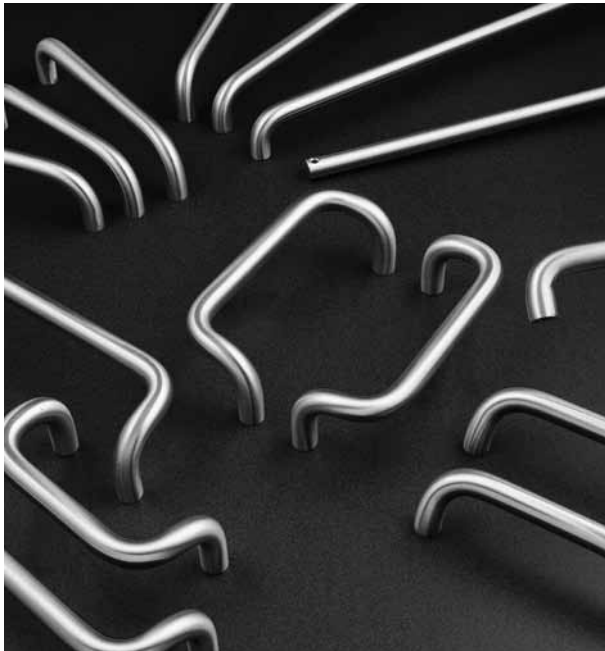
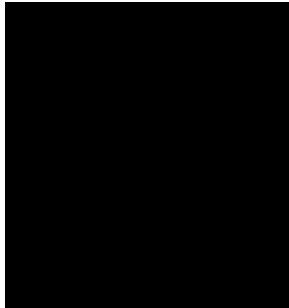
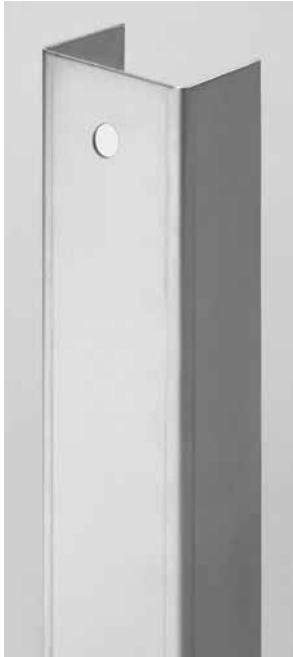

Rockwood Products Price Book - Accessories

USA & Canada Prices Effective June 3, 2019

| Table of Contents | Page # |
|--|--------|
| Architectural Finishes | 33 |
| Angle Plates | 29 |
| Auxiliary Hardware | 27 |
| Card Holder | 25 |
| Coordinators | 27 |
| Corner Guards | 21 |
| Covers | 28 |
| Custom Strikes | 29 |
| Decals | 25 |
| Door Edges | 21-22 |
| Door Guards | 25 |
| Door Knockers & Viewers | 25 |
| Door Plates - Kick Plates/Armor Plates | 30-32 |
| Door Pulls | 16-20 |
| Door Silencers | 25 |
| Door Stops | 23-24 |
| Fasteners - Spare Parts | 38-41 |
| Filler Plates & Shims | 29 |
| Flush Bolts | 27 |
| Flush Bolts - Manual | 24 |
| Flush Pulls | 15 |
| Gate Latch | 24 |
| Gravity Door Coordinators | 24 |
| General Information | 8 |
| Latch Protectors | 22 |
| Mounting Details | 34-37 |
| Mounting Kits | 42 |
| Numeric Index | 4-7 |
| Overhead Holders & Stops | 28 |
| Pivots | 29 |
| Privacy Door Latch | 25 |
| Pull Plate Sets | 14 |
| Pull Plates | 20-21 |
| Push and Pull Bars | 9 |
| Push Plate Ordering Information | 12 |
| Push Plates | 13-15 |
| Roller Latches | 24 |
| Series 47 Push Bars | 10 |
| Series 47 Tubular Push & Pull Bars | 11 |
| Signs | 26 |
| Surface Bolts | 24-25 |
| Trim Protector Bars | 29 |
| Vandal Resistant Trim & Vandal Resistant Pulls | 20 |
| Wall Guard | 25 |

| No. | Description | Page | No. | Description | Page |
|---------------------|--|------|-------------------|------------------------------|------|
| 10-PB | Push Bar | 9 | 96 | Flush Pull | 15 |
| 10BO | Bracket for #10 | 9 | 102-RKW | Straight Door Pull | 16 |
| 11-PB – 18-PB | Push Bars | 9 | 102 x 70 | Pull Plates | 20 |
| 19-PB | Push Bar | 9 | 105 | Straight Door Pull | 16 |
| 20-PB – 23-PB | Pull Bars | 9 | 105 x 70 | Pull Plates | 20 |
| 25-PB – 26-PB | Push Bars | 9 | 106-RKW | Straight Door Pull | 16 |
| 27-PB – 30-PB | Push Pull Bar Sets | 9 | 106 x 70 | Pull Plates | 20 |
| 31-PB – 32-PB | Pull Bars | 9 | 107 | Straight Door Pull | 16 |
| 33-PB – 34-PB | Push Bars | 9 | 107 x 70 | Pull Plates | 20 |
| 35-PB – 36-PB | Push Pull Bar Sets | 9 | 107 x 73B/73BL | Pull Plate Set | 14 |
| 40-PB – 42-PB | Screen Door Guards | 9 | 108 – 110-RKW | Straight Door Pull | 16 |
| 43-PB – 45-PB | Push Bars | 9 | 110 x 70 | Pull Plates | 20 |
| 47-PB, -2-PB, -3-PB | Series 47 Push Bars | 10 | 110 x 73C/73CL | Pull Plate Set | 14 |
| 48-PB | Series 47 Push Bar | 10 | 110-6SP | Security Door Pull | 16 |
| 50-PB | Pull Bar | 9 | 111, 111A | Straight Door Pull | 16 |
| 51-PB | Push Bar | 9 | 111 x 70 | Pull Plates | 20 |
| 51BO | Bracket for #50 | 9 | 111 x 73C/73CL | Pull Plate Set | 14 |
| 52-PB | Push Pull Bar Set | 9 | 112 | Straight Door Pull | 16 |
| 53-PB | Push Pull Bar Set | 9 | 118 | Straight Door Pull | 16 |
| 70 Series | Push Plates - .050" Thick | 13 | 120 – 122-RKW | Door Pulls | 17 |
| 71 Series | Push Plates - .062" Thick | 13 | 122 x 70 | Pull Plates | 20 |
| 73 Series | Push Plates - .125" Thick | 14 | 123 | Door Pull | 17 |
| 75 Series | Push Plates - .125" Thick | 14 | 123 x 70 | Pull Plates | 20 |
| 76 Series | Decorative Push Plates - .050" Thick | 14 | 125-RKW | Door Pull | 17 |
| 77 Series | Decorative Push Plates - .050" Thick | 14 | 125 x 70 | Pull Plates | 20 |
| 80 – 86 | Push Plates - .050" Thick | 15 | 126-RKW | Door Pull | 17 |
| 87 | Push Plate - .125" Thick | 15 | 126 x 70 | Pull Plates | 20 |
| 90, 90B | Cylinder Pulls | 15 | 130-RKW – 132-RKW | Cast Door Pulls | 17 |
| 91-RKW – 93-RKW | Combination Push Pull Plates | 15 | 132 x 70 | Pull Plates | 20 |
| 94, 94BTB | Flush Pulls | 15 | 134-RKW – 137 | Cast Door Pulls | 17 |
| 94C | Flush Pull | 15 | 137 x 70 | Pull Plates | 20 |
| 94DLL, 94DLS | Dead Lock Flush Pulls | 15 | 138 – 139 | Cast Door Pulls | 17 |
| 94L, 94P | Flush Pulls | 15 | 147, 147L | Cast Door Pulls | 17 |
| 94P x 94L | Flush Pull Set | 15 | 147 x 76, 77 | Decorative Pull Plates | 21 |
| 95A, 95B | Flush Pulls | 15 | 148 | Cast Door Pull | 17 |
| 95R | Flush Pull - Round | 15 | 148 x 76, 77 | Decorative Pull Plates | 21 |

| No. | Description | Page | No. | Description | Page |
|---------------|---------------------------------|------|----------------|--|------|
| 149 | Cast Door Pull..... | 17 | 488 – 489 | Door Stops..... | 24 |
| 176-RKW – 177 | Offset Door Pulls..... | 19 | 490 | Door Holder & Stop..... | 24 |
| 185 | Offset Door Pull..... | 19 | 491-RKW – 494S | Automatic Door Holders & Stops..... | 24 |
| 193 | Hospital Door Pull..... | 19 | 505-RKW – 508 | Cast Brass Door Stops..... | 24 |
| 208 | Wooden Door Pull..... | 19 | 517 | Aluminum Door Stop..... | 24 |
| 215, 215L | Tapered Door Pulls..... | 19 | 518 – 519 | Cast Brass Door Stops..... | 24 |
| 290 – 296 | Corner Guards..... | 21 | 520 | Replacement Bumper..... | 24 |
| 300 – 302B | Mortise Door Edges..... | 21 | 525 – 526 | Spring Base Door Stops..... | 24 |
| 304 – 307 | Non-Mortise Door Edges..... | 22 | 528 | Hinge Pin Stop..... | 24 |
| 308 – 310B-BS | Overlapping Door Edges..... | 22 | 550 Series | Lever Ext. Flush Bolt, Guide & Strike..... | 24 |
| 320-RKW – 330 | Latch Protectors..... | 22 | 554 Series | Rabbit Piece, Guide & Strike..... | 24 |
| 400 – 405 | Solid Cast Wall Stops..... | 23 | 555 Series | Lever Ext. Flush Bolt, Bolt Head, Guide & Strike..... | 24 |
| 406 – 409 | Wrought Wall Stops..... | 23 | 555ROD | Optional Bolt Lengths..... | 24 |
| 412 – 416 | Solid Cast Wall Stops..... | 23 | 555 x BFB | Flush Bolt w/Bottom Fire Bolt..... | 24 |
| 426 | Wall Stop..... | 23 | 556WS | Lever Ext. Wind Storm Flush Bolt..... | 24 |
| 430-RKW | Solid Cast Wall Stop..... | 23 | 557 Series | Lever Ext. Flush Bolt & Strike..... | 24 |
| 431-RKW, 432W | Wall Stops..... | 23 | 570 | Dust Proof Strike..... | 24 |
| 440 – 441 | Low Dome Stops..... | 23 | 576, 576B | Gravity Door Coordinator..... | 24 |
| 441CU | Dome Stop Combination Unit..... | 23 | 580 Series | Surface Bolts..... | 24 |
| 441H | Cast Universal Dome Stop..... | 23 | 582 Series | Surface Bolts..... | 24 |
| 442 – 443 | High Dome Stops..... | 23 | 585 Series | Heavy Duty Surface Bolts..... | 24 |
| 444 | Cast Door Stop Riser..... | 23 | 590 – 594 | Roller Latches..... | 24 |
| 445, 445H | Heavy Duty Door Stops..... | 23 | 602 | Secret Gate Latch..... | 24 |
| 446 | Door Stop..... | 23 | 603 – 604 Shim | Door Guards w/Shim..... | 25 |
| 449 | Door Stop Riser..... | 23 | 605, 605SMS | Door Guard Protection Plates..... | 25 |
| 455 | Curved Roller Stop..... | 23 | 606-RKW | Wall Guard..... | 25 |
| 456-RKW, 456L | Straight Roller Stops..... | 23 | PDL | Privacy Door Latch..... | 25 |
| 458 | Kick Down Door Stop..... | 23 | 608-RKW – 609 | Door Silencers..... | 25 |
| 459 | Spring Loaded Plunger Stop..... | 23 | 611 | Door Knocker..... | 25 |
| 460 – 461L | Kick Down Door Stops..... | 23 | 614, 614V | Door Knockers..... | 25 |
| 462 – 468-RKW | Heavy Duty Door Stops..... | 23 | 619 | 160° Door Viewer..... | 25 |
| 470 – 481 | Door Stops..... | 23 | 620 | 160° Door Viewer..... | 25 |
| 481MP | Heavy Duty Mounting Plate..... | 23 | 620VC | Viewer Cover for 619..... | 25 |
| 482 – 485 | Door Stops..... | 23 | 621 | 160° Door Viewer..... | 25 |
| 486 | Angle Door Stop..... | 23 | 622 | 190° Door Viewer..... | 25 |
| 487 | Heavy Duty Wall Stop..... | 23 | | | |

| No. | Description | Page | No. | Description | Page |
|-------------------|--|------|-------------------|--|------|
| 622VC | Viewer Cover for 622 | 25 | 2960, 2962 | Automatic Flush Bolts | 27 |
| 624 | 160° Door Viewer w/Cover | 25 | 11047, -2, -3 | Straight Push Pull Bar Sets | 10 |
| 626 – 629 | 190° Door Viewers w/Cover | 25 | 11147, -2, -3 | Straight Push Pull Bar Sets | 10 |
| 630 Series | Surface Bolts | 25 | 111A47, -2, -3 | Straight Push Pull Bar Sets | 10 |
| 651 | Card Holder | 25 | 11247, -2, -3 | Straight Push Pull Bar Sets | 10 |
| 660, 661, 662-RKW | Decals | 25 | 11847 | Straight Push Pull Bar Set | 10 |
| 670 Series | Engraved Signs..... | 26 | BF97, BF97L | Barrier Free Flush Pulls..... | 15 |
| 674H, 674L | Engraved Signs..... | 26 | BF150 – BF159 | 90° Offset Door Pulls | 18 |
| 700 – 702 | Hand Rail Brackets..... | 27 | BF156 – BF159 C17 | 90° Offset Door Pull Sets..... | 18 |
| 790 | Small Coat Hook..... | 27 | BF160 – BF169 | 45° Offset Door Pulls | 19 |
| 796 | Small Double Coat Hook..... | 27 | BF257 – BF260 | Heavy Duty Offset Door Pulls..... | 20 |
| 802, 806 | Medium Coat Hooks..... | 27 | BF680 Series | Engraved Signs w/Braille..... | 26 |
| 841 | Ball Knob..... | 27 | BF683 – BF689 | ADA Tactile Signs w/Braille | 26 |
| 845 | Utility Pull..... | 27 | BF15647, -2, -3 | Offset Push Pull Bar Sets..... | 10 |
| 850 – 856-RKW | Wire Pulls..... | 27 | BF15747, -2, -3 | Offset Push Pull Bar Sets..... | 10 |
| 860 | Flush Cup Pull..... | 27 | BF157A47, -2, -3 | Offset Push Pull Bar Sets..... | 10 |
| 870 | Wrought Flush Pull | 27 | BF15847, -2, -3 | Offset Push Pull Bar Sets..... | 10 |
| 872 | Cast Flush Pull..... | 27 | BF15947 | Offset Push Pull Bar Set | 10 |
| 880 | Cast Lever Edge Pull..... | 27 | BFLG10 – BFLG16 | Latch Guard Covers | 28 |
| 885-RKW | Concealed Edge Pull..... | 27 | BFM624, BFM625 | All Gender Restroom Signs | 26 |
| 890 – 891 | Pocket Door Pulls | 27 | BFM682 – BFM689 | Tactile ADA Molded Plastic Signs w/Braille..... | 26 |
| 900 – 901 | Magnetic Catches..... | 27 | BFRC12, BFRC24 | Vertical Rod Covers | 28 |
| 910 – 911 | Adjustable Ball Catches | 27 | BP47, -2, -3 | Series 47 Push Bars w/Base Plate..... | 10 |
| 1100 | Carry Bar | 27 | CP10 – CP10HD | Pivots - Standard Head | 29 |
| 1700 | Door Coordinator | 27 | CP40 – CP40HD | Pivots - Standard Floor | 29 |
| 2600 Series | Door Coordinators | 27 | CPK2840 | Cover Plate Kit | 27 |
| 2805 | Self Latching Flush Bolt (Top Only)..... | 27 | CS Series | Custom Strikes | 29 |
| 2840, 2842 | Automatic Flush Bolt Sets..... | 27 | D89 | Security Flush Pull | 15 |
| 2845 | Combination Flush Bolt Set | 27 | D133-RKW | Security Loop Door Pull..... | 17 |
| 2848, 2849 | Flush Bolts w/Bottom Fire Bolt | 27 | DF86 | Door Edge Filler Plate..... | 29 |
| 2905 | Self Latching Flush Bolt (Top Only)..... | 27 | DFF4 | Frame Hinge Filler Plates | 29 |
| 2940, 2942 | Automatic Flush Bolt Set..... | 27 | DFF5 | Frame Hinge Filler Plates | 29 |
| 2945 | Combination Flush Bolt Set | 27 | DHF4B | Door Hinge Filler Plates | 29 |
| 2948, 2949 | Flush Bolts w/Bottom Fire Bolt | 27 | | | |

| No. | Description | Page | No. | Description | Page |
|---------------------|--|------|---------------------|--|-------|
| DHF4S | Door Hinge Filler Plates | 29 | R101LPB | Trim Protector Bars..... | 29 |
| DHF5B | Door Hinge Filler Plates | 29 | R102LPB | Trim Protector Bars..... | 29 |
| DHF5S | Door Hinge Filler Plates | 29 | R111LPB | Trim Protector Bars..... | 29 |
| FB-1, -2 | Filler Bars..... | 27 | R112LPB | Trim Protector Bars..... | 29 |
| FBF48 | Flush Bolt Filler Plate | 29 | R115LPB | Trim Protector Bars..... | 29 |
| FBS48 | Flush Bolt Strike Filler Plate | 29 | R116EDPH | Exit Device Protector | 29 |
| FC161 | Door Face Filler Plate..... | 29 | R116EDPL | Exit Device Protector | 29 |
| FD160 | Door Face Filler Plate..... | 29 | SD1230 | Standard Duty Trim Protector Bar..... | 29 |
| HD2230 | Heavy Duty Trim Protector Bars | 29 | SD1240 | Standard Duty Trim Protector Bar..... | 29 |
| HD2240 | Heavy Duty Trim Protector Bars | 29 | SD1250 | Standard Duty Trim Protector Bar..... | 29 |
| HD2250 | Heavy Duty Trim Protector Bars | 29 | SD1260 | Standard Duty Trim Protector Bar..... | 29 |
| HS42 | 4 Hinge Shims | 29 | SF160 | Strike Filler Plate | 29 |
| HS44 | 4 1/2" Hinge Shims | 29 | SFASA | Strike Filler Plate | 29 |
| HS52 | 5" Hinge Shims | 29 | SFB160 | Strike Filler Plate | 29 |
| HS54 | 5" Hinge Shims | 29 | SP47 | Series 47 Push Bar | 10 |
| K1038 | Metal Door Plate - .038" Thick..... | 31 | SP1001 – SP1079 | Fasteners - Spare Parts | 38-41 |
| K1050, K1050F | Metal Door Plates - .050" Thick..... | 31 | T47, -2, -3 | Tubular Push Bars | 11 |
| K1050-1 – K1050-8 | Shaped Metal Door Plates - .050" Thick..... | 31 | T110 – T118 | Tubular Door Pulls | 16 |
| K1050A-1 – K1050A-8 | Shaped Metal Door Plates - .050" Thick..... | 31 | T110 x 70 | Tubular Pull Plates | 21 |
| K1062 | Metal Door Plate - .062" Thick..... | 32 | T111 x 70 | Tubular Pull Plates..... | 21 |
| K1125 | Metal Door Plate - .125" Thick..... | 32 | T11047 | Tubular Straight Push Pull Bar Sets..... | 11 |
| K2060 Series | Plastic Door Plates - .060" Thick..... | 32 | T11147 | Tubular Straight Push Pull Bar Sets..... | 11 |
| K2125 Series | Plastic Door Plates - .125" Thick..... | 32 | T111A47 | Tubular Straight Push Pull Bar Sets..... | 11 |
| K3125 | Laminate Plastic Door Plate - .125" Thick..... | 32 | T11247 | Tubular Straight Push Pull Bar Sets..... | 11 |
| K4125 | Clear Plastic Door Plate - .125" Thick..... | 32 | T11847 | Tubular Straight Push Pull Bar Set..... | 11 |
| KB1150 – KB1152 | Angle Plates - .050" Thick | 29 | TBF156 – TBF159 | Tubular 90° Offset Door Pulls | 18 |
| KIT Series | Mounting Kits for Door Pulls | 42 | TBF156 – TBF159 C17 | Tubular 90° Offset Door Pull Sets | 18 |
| LA86 | Latch Adapter Plate | 29 | TBF15647 | Tubular Offset Push Pull Bar Sets..... | 11 |
| LF161 | Door Edge Filler Plate..... | 29 | TBF15747 | Tubular Offset Push Pull Bar Sets..... | 11 |
| OH100 | HD Concealed Overhead Stops..... | 28 | TBF157A47 | Tubular Offset Push Pull Bar Sets..... | 11 |
| OH200 | Concealed Overhead Holders & Stops..... | 28 | TBF15847 | Tubular Offset Push Pull Bar Sets..... | 11 |
| OH900 | HD Surface Overhead Stops | 28 | TBF15947 | Tubular Offset Push Pull Bar Set..... | 11 |
| OH1000 | Surface Overhead Holders & Stops..... | 28 | VRP30 | Vandal Resistant Pull..... | 20 |
| PDL | Privacy Door Latch..... | 25 | VRT12 – VRT26 | Vandal Resistant Trim | 20 |

Ordering Information

This price list cancels and supersedes all prior listings.

Orders are accepted with the understanding that they will be billed at prices in effect at time of shipment.

Prices are subject to change without notice.

We reserve the right to decline the whole or part of orders in which the price or quantity of goods is not acceptable to us.

Easy Order Placement

USA:

By Phone: 1-800-458-2424 Monday through Thursday 8:00 am ET to 7:00 pm ET, Friday 8:00 am ET to 4:30 pm ET

By Fax: Orders may be faxed to 1-800-922-9212

By Email: orders.rockwood@assaabloy.com

By Internet: <http://extranet.assaabloydss.com/> and select Order Entry under the Customer Service Menu

Canada:

By Phone: 1-800-461-3007 Monday through Friday 8:00 am ET to 4:30 pm ET

By Fax: Orders may be faxed to 1-800-461-8989

By Email: cavau-orders@assaabloy.com

By Internet: <http://extranet.assaabloydss.ca/> and select Order Entry under the Customer Service Menu

Terms and Conditions of Sale

Terms: 1% 15 days, net 30 days

Remit Payment To: PNC Bank/Rockwood, PO Box 644489, Pittsburgh, PA 15264-4489

For Terms & Conditions and Warranty information pertaining to product sales in Canada, please visit www.assaabloy.ca/terms

Freight Policy

Freight Allowance: All prices are F.O.B. Rockwood, Pennsylvania and/or Ventura, California. Full freight will be allowed on shipments of \$1,000 net and over within the continental limits of the United States (excluding Alaska and Hawaii). All shipments are routed most cost effective route of our choice. We reserve the right to designate the carrier.

Special Order Material

Special items made to your specifications are not returnable. These items are not subject to cancellation without consideration of expense involved at the cancellation date.

Samples

Salable samples will be charged at regular prices.

Returned Goods

Return no merchandise without written permission from the factory. Authorization will insure your receiving proper credit. Errors in shipping may occasionally occur. If this is the case immediately notify the factory, and we will gladly make the proper adjustments. If the error is at the customer's end, a minimum charge of 25% plus freight will be incurred for handling. Unauthorized claims for labor or charges will not be allowed. No credit will be allowed beyond six months after invoice date.

Shortages

Claims for shortages must be made within 30 days of invoice date.

Templates

Upon request we will furnish templates for any of our standard items of manufacture. Commonly used templates are available on our website at www.assaabloydooraccessories.us.

Product Weight Information

NOTE: Weights indicated throughout the price list are approximate for brass, bronze or stainless steel base material. Aluminum base materials weigh approximately $\frac{1}{3}$ the listed weights.

Engraving

Engraving may be added on many pulls and plates. Call factory for pricing.

For Terms and Conditions as well as Warranty information pertaining to product sales in Canada, please visit www.assaabloy.ca/terms

ASSA ABLOY

Opening Solutions

The global leader in
door opening solutions

Push and Pull Bars

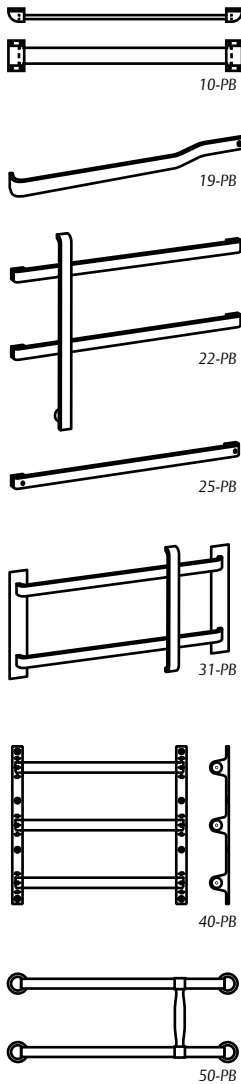

| Push and Pull Bars | | | | | | | |
|--------------------|----------|----------------|-------------------|----------|-------------------|----------|----------|
| Part | 28/628 | 3/605 4/606 | 10/612 10B/613 | 10BE/BSP | 26/625 26D/626 | 32D/630 | 32DMS |
| 10-PB | | 814.00 | 814.00 | 793.00 | 786.00 | | |
| 10BO | | 258.00 | 258.00 | 255.00 | 250.00 | | |
| 11-PB | 329.00 | 670.00 | 765.00 | 402.00 | 741.00 | 350.00 | 372.00 |
| 12-PB | 329.00 | 670.00 | 765.00 | 402.00 | 741.00 | 350.00 | 372.00 |
| 14-PB | 329.00 | 765.00 | 858.00 | 440.00 | 832.00 | 379.00 | 405.00 |
| 15-PB | 329.00 | 765.00 | 858.00 | 440.00 | 832.00 | 379.00 | 405.00 |
| 18-PB | 329.00 | 765.00 | 858.00 | 440.00 | 832.00 | 379.00 | 405.00 |
| 19-PB | 329.00 | 765.00 | 858.00 | 440.00 | 832.00 | 379.00 | 405.00 |
| 20-PB | 804.00 | 1,761.00 | 2,049.00 | 964.00 | 1,984.00 | 835.00 | 857.00 |
| 21-PB | 911.00 | 1,901.00 | 2,331.00 | 1,074.00 | 2,262.00 | 928.00 | 955.00 |
| 22-PB | 926.00 | 1,998.00 | 2,280.00 | 1,111.00 | 2,213.00 | 961.00 | 984.00 |
| 23-PB | 984.00 | 2,144.00 | 2,568.00 | 1,168.00 | 2,493.00 | 1,009.00 | 1,032.00 |
| 25-PB | 316.00 | 670.00 | 765.00 | 348.00 | 741.00 | 299.00 | 323.00 |
| 26-PB | 329.00 | 717.00 | 858.00 | 365.00 | 832.00 | 314.00 | 341.00 |
| 27-PB | 1,418.00 | 3,090.00 | 3,564.00 | 1,659.00 | 3,458.00 | 1,433.00 | 1,455.00 |
| 28-PB | 1,563.00 | 3,327.00 | 4,042.00 | 1,802.00 | 3,924.00 | 1,508.00 | 1,581.00 |
| 29-PB | 1,546.00 | 3,471.00 | 3,801.00 | 1,802.00 | 3,687.00 | 1,554.00 | 1,581.00 |
| 30-PB | 1,636.00 | 3,564.00 | 4,279.00 | 1,481.00 | 4,150.00 | 1,635.00 | 1,658.00 |
| 31-PB | 806.00 | 1,894.00 | 2,115.00 | 1,205.00 | 2,053.00 | 1,038.00 | 1,065.00 |
| 32-PB | 849.00 | 1,931.00 | 2,166.00 | 1,235.00 | 2,101.00 | 1,065.00 | 1,090.00 |
| 33-PB | 699.00 | 1,504.00 | 1,685.00 | 942.00 | 1,637.00 | 811.00 | 839.00 |
| 34-PB | 740.00 | 1,561.00 | 1,750.00 | 971.00 | 1,696.00 | 840.00 | 864.00 |
| 35-PB | 1,194.00 | 3,396.00 | 3,793.00 | 2,147.00 | 3,683.00 | 1,854.00 | 1,876.00 |
| 36-PB | 1,227.00 | 3,490.00 | 3,906.00 | 2,206.00 | 3,818.00 | 1,900.00 | 1,927.00 |
| 40-PB | | 706.00 | 706.00 | 618.00 | 683.00 | | |
| 41-PB | | 499.00 | 499.00 | 438.00 | 483.00 | | |
| 42-PB | | 361.00 | 361.00 | 316.00 | 349.00 | | |
| 43-PB | 374.00 | 1,120.00 | 1,340.00 | 779.00 | 1,299.00 | 671.00 | 697.00 |
| 44-PB | 346.00 | 1,046.00 | 1,256.00 | 734.00 | 1,218.00 | 633.00 | 658.00 |
| 45-PB | 325.00 | 950.00 | 1,138.00 | 693.00 | 1,103.00 | 600.00 | 622.00 |
| 50-PB | | 935.00 | 1,023.00 | 897.00 | 991.00 | | |
| 51-PB | | 375.00 | 412.00 | 363.00 | 398.00 | | |
| 51BO | | 71.00 | 80.00 | 71.00 | 78.00 | | |
| 52-PB | | 1,672.00 | 1,836.00 | 1,610.00 | 1,784.00 | | |
| 53-PB | | 319.00 | 358.00 | 316.00 | 347.00 | | |

Push & Pull Extra Length Bars

| Extra Length Bars | | | | | | |
|-----------------------|--------|----------------|-------------------|----------|----------------|---------|
| Description | 28/628 | 3/605 4/606 | 10/612 10B/613 | 10BE/BSP | 26/625 26D/626 | 32D/630 |
| Over 3/4" thru 1 1/2" | 6.60 | 13.00 | 15.30 | 15.30 | 13.00 | 10.90 |
| Over 1 1/2" thru 3" | 8.70 | 17.40 | 19.60 | 21.20 | 17.40 | 15.30 |

Bars over 36" add per inch the following additional cost.

Mounting Types for Push Bars 10 through 45 and 50, 51, 52

Mounting charge included in list price.

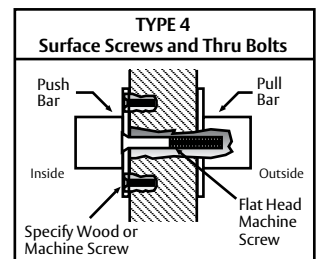
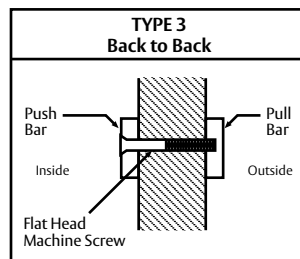
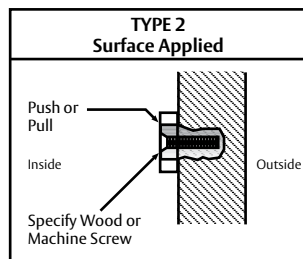
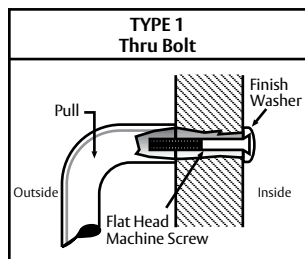

Series 47 Push Bars

| Series 47 Push Bars | | | | | | | | | | | | |
|---|--------|---------------------------|----------------|-------------------|----------|----------|----------|----------|----------|----------|----------|----------|
| Part | 28/628 | 313/710 314 315/711 | 3/605 4/606 | 10/612 108/613 | 10BE/BSP | 26D/626 | 26/625 | 32D/630 | 32/629 | 32DMS | 32D316 | 32316 |
| SP47 | 182.00 | 219.00 | 549.00 | 687.00 | 555.00 | 528.00 | 528.00 | 485.00 | 543.00 | 512.00 | 647.00 | 696.00 |
| 47-PB | 111.00 | 124.00 | 433.00 | 568.00 | 503.00 | 427.00 | 444.00 | 293.00 | 337.00 | 518.00 | 654.00 | 685.00 |
| 47-2-PB | 306.00 | 374.00 | 1,032.00 | 1,032.00 | 1,023.00 | 1,000.00 | 1,000.00 | 864.00 | 972.00 | 984.00 | 1,205.00 | 1,264.00 |
| 47-3-PB | 456.00 | 456.00 | 1,547.00 | 1,547.00 | 1,531.00 | 1,502.00 | 1,502.00 | 1,296.00 | 1,457.00 | 1,475.00 | 1,805.00 | 1,896.00 |
| 48-PB | 154.00 | 182.00 | 407.00 | 480.00 | 322.00 | 393.00 | 393.00 | 264.00 | 341.00 | 356.00 | 387.00 | 443.00 |
| BP47 | 244.00 | 276.00 | 605.00 | 605.00 | 593.00 | 586.00 | 586.00 | 525.00 | 567.00 | 549.00 | 694.00 | 722.00 |
| BP47-2 | 489.00 | 553.00 | 1,295.00 | 1,295.00 | 1,274.00 | 1,256.00 | 1,256.00 | 1,127.00 | 1,215.00 | 1,225.00 | 1,467.00 | 1,526.00 |
| BP47-3 | 639.00 | 738.00 | 1,836.00 | 1,836.00 | 1,813.00 | 1,784.00 | 1,784.00 | 1,597.00 | 1,727.00 | 1,745.00 | 2,101.00 | 2,190.00 |
| Straight Single Bar Sets | | | | | | | | | | | | |
| 11047 | 173.00 | 200.00 | 594.00 | 755.00 | 675.00 | 592.00 | 608.00 | 404.00 | 472.00 | 695.00 | 887.00 | 950.00 |
| 111A47 | 238.00 | 279.00 | 780.00 | 868.00 | 738.00 | 753.00 | 753.00 | 633.00 | 705.00 | 701.00 | 899.00 | 961.00 |
| 11147 | 177.00 | 202.00 | 613.00 | 780.00 | 695.00 | 606.00 | 626.00 | 415.00 | 485.00 | 720.00 | 806.00 | 915.00 |
| 11247 | 179.00 | 204.00 | 630.00 | 808.00 | 718.00 | 626.00 | 645.00 | 425.00 | 497.00 | 737.00 | 943.00 | 1,008.00 |
| 11847 | 247.00 | 297.00 | 864.00 | 954.00 | 790.00 | 838.00 | 838.00 | 693.00 | 765.00 | 761.00 | 959.00 | 1,014.00 |
| Straight Double Bar Sets | | | | | | | | | | | | |
| 11047-2 | 265.00 | 301.00 | 957.00 | 1,911.00 | 1,192.00 | 968.00 | 980.00 | 1,123.00 | 1,084.00 | 1,149.00 | 1,419.00 | 1,505.00 |
| 111A47-2 | 322.00 | 377.00 | 1,128.00 | 2,011.00 | 1,198.00 | 1,103.00 | 1,114.00 | 1,332.00 | 1,303.00 | 1,156.00 | 1,431.00 | 1,515.00 |
| 11147-2 | 478.00 | 549.00 | 1,716.00 | 1,933.00 | 1,217.00 | 1,698.00 | 1,750.00 | 1,136.00 | 1,095.00 | 1,175.00 | 1,345.00 | 1,475.00 |
| 11247-2 | 270.00 | 308.00 | 993.00 | 1,958.00 | 1,232.00 | 982.00 | 1,012.00 | 1,147.00 | 1,105.00 | 1,191.00 | 1,474.00 | 1,560.00 |
| Straight Triple Bar Sets | | | | | | | | | | | | |
| 11047-3 | 367.00 | 415.00 | 1,354.00 | 3,104.00 | 1,697.00 | 1,361.00 | 1,383.00 | 1,854.00 | 1,715.00 | 1,639.00 | 2,018.00 | 2,132.00 |
| 111A47-3 | 424.00 | 490.00 | 1,526.00 | 3,201.00 | 1,702.00 | 1,495.00 | 1,519.00 | 2,060.00 | 1,934.00 | 1,643.00 | 2,030.00 | 2,141.00 |
| 11147-3 | 581.00 | 660.00 | 2,112.00 | 3,129.00 | 1,720.00 | 2,094.00 | 2,155.00 | 1,862.00 | 1,728.00 | 1,662.00 | 1,944.00 | 2,100.00 |
| 11247-3 | 372.00 | 419.00 | 1,386.00 | 3,150.00 | 1,738.00 | 1,377.00 | 1,417.00 | 1,876.00 | 1,740.00 | 1,678.00 | 2,074.00 | 2,188.00 |
| Offset Single Bar Sets | | | | | | | | | | | | |
| BF15647 | 202.00 | 229.00 | 674.00 | 868.00 | 767.00 | 676.00 | 696.00 | 447.00 | 520.00 | 765.00 | 1,014.00 | 1,080.00 |
| BF157A47 | 204.00 | 231.00 | 692.00 | 895.00 | 785.00 | 694.00 | 712.00 | 460.00 | 540.00 | 775.00 | 1,029.00 | 1,094.00 |
| BF15747 | 204.00 | 231.00 | 692.00 | 895.00 | 790.00 | 694.00 | 712.00 | 460.00 | 540.00 | 775.00 | 1,029.00 | 1,094.00 |
| BF15847 | 206.00 | 234.00 | 710.00 | 920.00 | 812.00 | 710.00 | 732.00 | 472.00 | 551.00 | 812.00 | 1,071.00 | 1,138.00 |
| BF15947 | 320.00 | 375.00 | 923.00 | 976.00 | 863.00 | 895.00 | 895.00 | 761.00 | 823.00 | 831.00 | 1,073.00 | 1,135.00 |
| Offset Double Bar Sets | | | | | | | | | | | | |
| BF15647-2 | 293.00 | 331.00 | 1,038.00 | 2,024.00 | 1,261.00 | 1,035.00 | 1,067.00 | 1,189.00 | 1,145.00 | 1,215.00 | 1,542.00 | 1,628.00 |
| BF157A47-2 | 293.00 | 331.00 | 1,038.00 | 2,024.00 | 1,271.00 | 1,035.00 | 1,067.00 | 1,189.00 | 1,147.00 | 1,226.00 | 1,554.00 | 1,638.00 |
| BF15747-2 | 293.00 | 331.00 | 1,038.00 | 2,024.00 | 1,288.00 | 1,035.00 | 1,067.00 | 1,189.00 | 1,147.00 | 1,226.00 | 1,554.00 | 1,638.00 |
| BF15847-2 | 297.00 | 335.00 | 1,056.00 | 2,047.00 | 1,304.00 | 1,074.00 | 1,083.00 | 1,200.00 | 1,156.00 | 1,259.00 | 1,589.00 | 1,681.00 |
| Offset Triple Bar Sets | | | | | | | | | | | | |
| BF15647-3 | 394.00 | 444.00 | 1,436.00 | 3,216.00 | 1,766.00 | 1,429.00 | 1,474.00 | 1,926.00 | 1,779.00 | 1,705.00 | 2,139.00 | 2,256.00 |
| BF157A47-3 | 394.00 | 444.00 | 1,436.00 | 3,216.00 | 1,778.00 | 1,429.00 | 1,474.00 | 1,926.00 | 1,781.00 | 1,715.00 | 2,151.00 | 2,264.00 |
| BF15747-3 | 394.00 | 444.00 | 1,436.00 | 3,216.00 | 1,789.00 | 1,429.00 | 1,474.00 | 1,926.00 | 1,781.00 | 1,715.00 | 2,151.00 | 2,264.00 |
| BF15847-3 | 396.00 | 447.00 | 1,453.00 | 3,240.00 | 1,809.00 | 1,468.00 | 1,490.00 | 1,934.00 | 1,790.00 | 1,748.00 | 2,190.00 | 2,307.00 |
| Series 47 Extra Length Bars - Bars over 36" add per inch the following additional cost per bar. | | | | | | | | | | | | |
| | 4.80 | 6.10 | 12.50 | 16.50 | 14.30 | 12.20 | 12.50 | 12.50 | 9.60 | 14.30 | 14.30 | 14.30 |

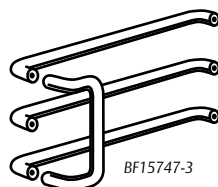
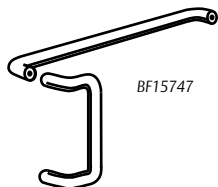
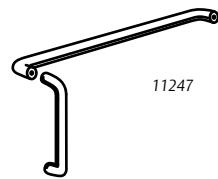

See page 35 for detailed mounting drawings. Engraving "Push" or "Pull" on 1" Series 47 Push Bars add \$204.00 (1/2" Letter Height).

Series 47 Tubular Push & Pull Bars

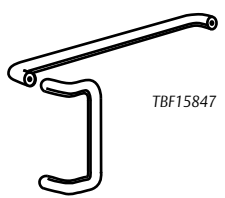
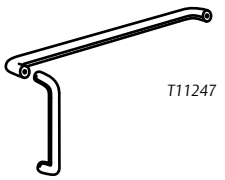

| Series 47 Tubular Push Bars | | | | | | |
|--|----------------|-------------------|----------|---------|--------|--------|
| Part | 3/605 4/606 | 10/612 10B/613 | 10BE/BSP | 32D/630 | 32/629 | 32DMS |
| T47 | 396.00 | 418.00 | 336.00 | 281.00 | 314.00 | 308.00 |
| T47-2 | 784.00 | 834.00 | 668.00 | 556.00 | 629.00 | 587.00 |
| T47-3 | 1,179.00 | 1,246.00 | 1,003.00 | 835.00 | 941.00 | 861.00 |
| Series 47 Tubular Straight Single Bar Sets | | | | | | |
| T11047 | 612.00 | 641.00 | 490.00 | 409.00 | 476.00 | 476.00 |
| T111A47 | 602.00 | 636.00 | 510.00 | 406.00 | 472.00 | 472.00 |
| T11147 | 602.00 | 636.00 | 487.00 | 406.00 | 472.00 | 472.00 |
| T11247 | 615.00 | 647.00 | 492.00 | 410.00 | 476.00 | 476.00 |
| T11847 | 647.00 | 670.00 | 519.00 | 433.00 | 505.00 | 501.00 |
| Series 47 Tubular Offset Single Bar Sets | | | | | | |
| TBF15647 | 656.00 | 681.00 | 501.00 | 421.00 | 518.00 | 480.00 |
| TBF157A47 | 662.00 | 692.00 | 507.00 | 427.00 | 522.00 | 489.00 |
| TBF15747 | 662.00 | 692.00 | 507.00 | 427.00 | 557.00 | 489.00 |
| TBF15847 | 670.00 | 701.00 | 515.00 | 433.00 | 526.00 | 493.00 |
| TBF15947 | 706.00 | 740.00 | 550.00 | 462.00 | 557.00 | 524.00 |

See page 35 for detailed mounting drawings. Engraving "Push" or "Pull" on 1" Series 47 Push Bars add \$204.00 (1/2" Letter Height).

TYPICAL MOUNTING

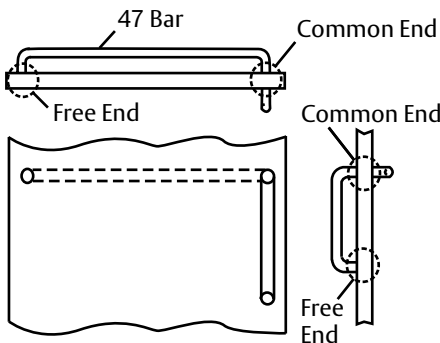

For Set Mounting Hardware, see page 34.

Location Standards

Positioning Applications:

- door pulls to plates
- engraving on plates
- cutouts on plates
- cutout and engraving on plates

Sizing:

- 1 1/4" standard cylinder hole cutout size
- 3/8" diameter standard thumbturn hole
- other cutout sizes and styles are readily available

NOTE: Be sure the pull you choose will fit on the plate, allowing for cutouts and/or engraving.

Pull Positioning on Plates 4" or Less in Width

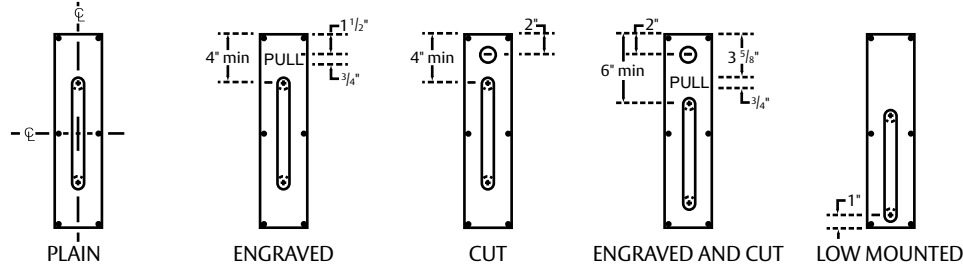

Pull Positioning on Plates Wider than 4" (Handing Required)

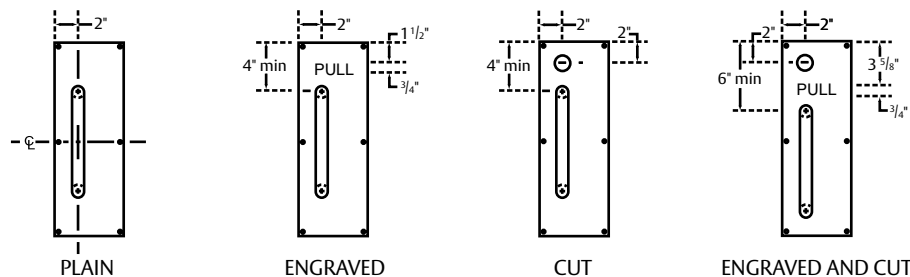

Recommended Locations on Door

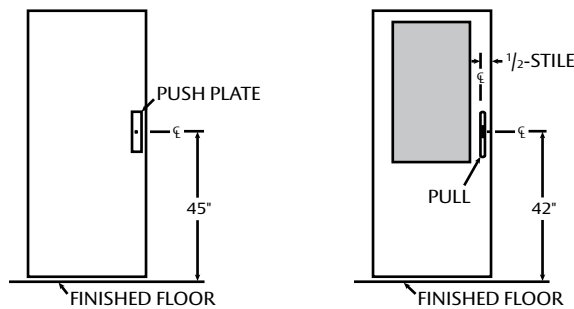

Engraving and Adhesive Mounting

| Description | Price |
|--|-------|
| Engraving "Push", "Pull", "Men" or "Women" | 97.00 |
| Push Plate Adhesive Mounting | 19.40 |

Engraving: 3/4" high condensed block letters with black enamel fill; other letter sizes and styles are readily available.

Additional Charges Per Thickness of Push Plate

| Part | Description | 70/.050" | 71/.062" | 73/.125" |
|-----------|-------------------|----------|----------|----------|
| CFC | Cut for Cylinder | 2.40 | 10.00 | 10.80 |
| CFTT | Cut for Thumbturn | 2.40 | 10.00 | 10.80 |
| Pull Prep | Prep for Pull | 4.80 | 20.00 | 21.60 |

ADA Accessibility Guidelines for Buildings and Facilities (ADAAG) as amended through January 1998 4.13.9 Door Hardware.

Handles, pulls, latches, locks, and other operating devices on accessible doors shall have a shape that is easy to grasp with one hand and does not require tight grasping, tight pinching, or twisting of the wrist to operate. Lever-operated mechanisms, push-type mechanisms, and U-shaped handles are acceptable designs. When sliding doors are fully open, operating hardware shall be exposed and usable from both sides. Hardware required for accessible door passage shall be mounted no higher than 48 in. (1220 mm) above finished floor.

ASSA ABLOY

Opening Solutions

The global leader in door opening solutions

Push Plates - .050" Thick

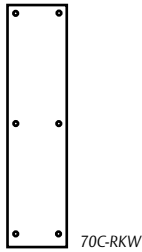

| No. 70 - Square Ends | | | | | | | | | | |
|----------------------|--------|----------------|-------------------|----------|---------|--------|---------|--------|-------|--------|
| Part | 28/628 | 3/605 4/606 | 10/612 10B/613 | 10BE/BSP | 26D/626 | 26/625 | 32D/630 | 32/629 | 32DMS | 32D316 |
| 70A | 18.10 | 36.20 | 40.70 | 35.80 | 36.20 | 38.40 | 14.90 | 23.40 | 40.50 | 49.60 |
| 70B | 20.40 | 45.20 | 47.50 | 44.70 | 45.20 | 47.50 | 19.20 | 23.40 | 42.60 | 49.60 |
| 70C-RKW | 24.90 | 52.00 | 57.00 | 49.20 | 52.00 | 55.00 | 18.90 | 27.70 | 46.90 | 55.00 |
| 70E | 31.80 | 74.00 | 83.00 | 74.00 | 77.00 | 79.00 | 27.70 | 42.60 | 77.00 | 88.00 |
| 70F | 36.30 | 100.00 | 106.00 | 99.00 | 102.00 | 104.00 | 40.50 | 53.00 | 85.00 | 106.00 |
| 70G | 38.50 | 77.00 | 93.00 | 54.00 | 85.00 | 85.00 | 42.60 | 58.00 | 60.00 | 70.00 |

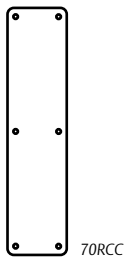

| No. 70RC - Round Corners | | | | | | | | | | |
|--------------------------|-------|--------|--------|-------|--------|--------|-------|-------|-------|--------|
| 70RCA | 38.50 | 61.00 | 63.00 | 40.20 | 61.00 | 61.00 | 31.90 | 42.60 | 46.90 | 57.00 |
| 70RCB | 40.80 | 66.00 | 74.00 | 49.20 | 72.00 | 72.00 | 40.50 | 51.00 | 49.00 | 57.00 |
| 70RCC | 40.80 | 74.00 | 83.00 | 54.00 | 81.00 | 81.00 | 44.70 | 55.00 | 51.00 | 61.00 |
| 70RCE | 55.00 | 104.00 | 117.00 | 83.00 | 113.00 | 113.00 | 68.00 | 87.00 | 83.00 | 95.00 |
| 70RCF | 59.00 | 119.00 | 142.00 | 89.00 | 138.00 | 138.00 | 75.00 | 96.00 | 89.00 | 108.00 |
| 70RCG | 38.50 | 74.00 | 97.00 | 61.00 | 91.00 | 91.00 | 49.00 | 62.00 | 64.00 | 72.00 |

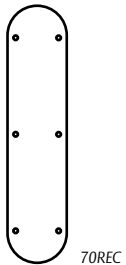

| No. 70RE - Round Ends | | | | | | | | | | |
|-----------------------|-------|-------|-------|-------|-------|-------|-------|-------|-------|-------|
| 70REA | 49.90 | 72.00 | 77.00 | 58.00 | 74.00 | 74.00 | 46.90 | 55.00 | 58.00 | 70.00 |
| 70REB | 55.00 | 77.00 | 89.00 | 63.00 | 83.00 | 83.00 | 51.00 | 62.00 | 60.00 | 70.00 |
| 70REC | 57.00 | 83.00 | 97.00 | 69.00 | 91.00 | 91.00 | 55.00 | 68.00 | 64.00 | 72.00 |

See page 12 for standard locations and sizes of Cylinder Cutouts (CFC) and Thumbturn Cutouts (CFTT), engraving and pricing.

Push Plates - .062" Thick

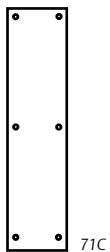

| No. 71 - Square Corners | | | |
|-------------------------|----------|---------|--------|
| Part | 10BE/BSP | 32D/630 | 32DMS |
| 71A | 51.00 | 42.60 | 68.00 |
| 71B | 58.00 | 46.90 | 72.00 |
| 71C | 67.00 | 53.00 | 81.00 |
| 71E | 87.00 | 72.00 | 96.00 |
| 71F | 103.00 | 83.00 | 109.00 |
| 71G | 76.00 | 62.00 | 87.00 |

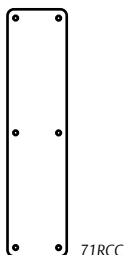

| No. 71RC - Round Corners | | | |
|--------------------------|--------|-------|--------|
| 71RCA | 63.00 | 51.00 | 77.00 |
| 71RCB | 69.00 | 55.00 | 81.00 |
| 71RCC | 76.00 | 62.00 | 87.00 |
| 71RCE | 103.00 | 81.00 | 104.00 |
| 71RCF | 109.00 | 87.00 | 115.00 |
| 71RCG | 87.00 | 72.00 | 96.00 |

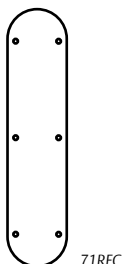

| No. 71RE - Round Ends | | | |
|-----------------------|-------|-------|--------|
| 71REA | 83.00 | 68.00 | 92.00 |
| 71REB | 87.00 | 72.00 | 96.00 |
| 71REC | 93.00 | 77.00 | 100.00 |

Concealed Mount Pull Plate Sets

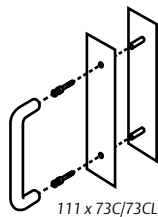

| Pull Plate x Plate with Lug | | | |
|-----------------------------|---------|--------|----------|
| Part | 32D/630 | 32DMS | 10BE/BSP |
| 107 x 73B/73BL | 331.00 | 379.00 | 393.00 |
| 110 x 73C/73CL | 435.00 | 499.00 | 517.00 |
| 111 x 73C/73CL | 450.00 | 518.00 | 534.00 |

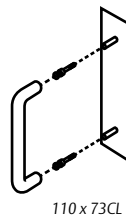

| Pull (only) x Plate with Lug | | | |
|------------------------------|---------|--------|----------|
| Part | 32D/630 | 32DMS | 10BE/BSP |
| 107 x 73BL | 232.00 | 265.00 | 276.00 |
| 110 x 73CL | 324.00 | 373.00 | 384.00 |
| 111 x 73CL | 344.00 | 397.00 | 412.00 |

See page 12 for standard locations and sizes of Cylinder Cutouts (CFC) and Thumbturn Cutouts (CFTT), engraving and pricing. See page 36 for detail drawing of Type 9 mounting.

Push Plates

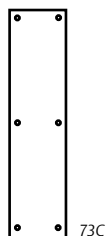

| No. 73 - Square Corners (.125" Thick) | | | | | | | | | |
|---------------------------------------|--------|----------------|-------------------|----------|-------------------|---------|--------|--------|--------|
| Part | 28/628 | 3/605 4/606 | 10/612 10B/613 | 10BE/BSP | 26/625 26D/626 | 32D/630 | 32/629 | 32DMS | 32D316 |
| 73A | 59.00 | 161.00 | 190.00 | 111.00 | 183.00 | 89.00 | 130.00 | 117.00 | 127.00 |
| 73B | 72.00 | 181.00 | 208.00 | 125.00 | 201.00 | 62.00 | 138.00 | 126.00 | 144.00 |
| 73C | 75.00 | 197.00 | 221.00 | 137.00 | 215.00 | 70.00 | 151.00 | 136.00 | 161.00 |
| 73E | 88.00 | 255.00 | 280.00 | 182.00 | 269.00 | 147.00 | 185.00 | 173.00 | 221.00 |
| 73F | 102.00 | 321.00 | 344.00 | 222.00 | 333.00 | 179.00 | 213.00 | 207.00 | 248.00 |
| 73G | 77.00 | 229.00 | 255.00 | 148.00 | 248.00 | 121.00 | 168.00 | 145.00 | 176.00 |

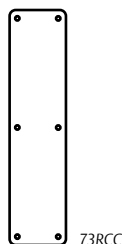

| No. 73RC - Round Corners (.125" Thick) | | | | | | | | | |
|--|--------|--------|--------|--------|--------|--------|--------|--------|--------|
| 73RCA | 88.00 | 183.00 | 212.00 | 134.00 | 201.00 | 106.00 | 153.00 | 134.00 | 149.00 |
| 73RCB | 93.00 | 195.00 | 224.00 | 143.00 | 217.00 | 117.00 | 158.00 | 141.00 | 158.00 |
| 73RCC | 97.00 | 219.00 | 244.00 | 152.00 | 233.00 | 128.00 | 179.00 | 153.00 | 176.00 |
| 73RCE | 116.00 | 276.00 | 301.00 | 206.00 | 291.00 | 166.00 | 215.00 | 192.00 | 244.00 |
| 73RCF | 131.00 | 344.00 | 367.00 | 248.00 | 355.00 | 202.00 | 236.00 | 226.00 | 271.00 |
| 73RCG | 105.00 | 248.00 | 276.00 | 170.00 | 267.00 | 138.00 | 194.00 | 164.00 | 197.00 |

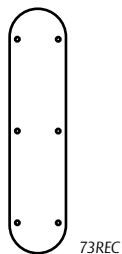

| No. 73RE - Round Ends (.125" Thick) | | | | | | | | | |
|-------------------------------------|--------|--------|--------|--------|--------|--------|--------|--------|--------|
| 73REA | 129.00 | 221.00 | 248.00 | 176.00 | 242.00 | 143.00 | 187.00 | 168.00 | 185.00 |
| 73REB | 141.00 | 233.00 | 260.00 | 184.00 | 251.00 | 149.00 | 194.00 | 175.00 | 194.00 |
| 73REC | 143.00 | 248.00 | 271.00 | 196.00 | 263.00 | 160.00 | 209.00 | 185.00 | 212.00 |

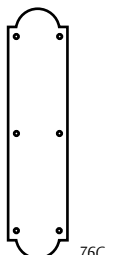

| Laminate and Clear Plastic - Square Corners (.125" Thick) | | | | | | | | | |
|---|-------|-------|-------|-------|-------|--|--|--|--|
| Part | Black | Brown | Gray | Beige | Clear | | | | |
| 75A | 30.00 | 30.00 | 30.00 | 30.00 | 30.00 | | | | |
| 75B | 32.00 | 32.00 | 32.00 | 32.00 | 32.00 | | | | |
| 75C | 32.00 | 32.00 | 32.00 | 32.00 | 34.00 | | | | |
| 75E | 39.00 | 39.00 | 39.00 | 39.00 | 41.00 | | | | |
| 75F | 43.00 | 43.00 | 43.00 | 43.00 | 46.00 | | | | |
| 75G | 36.00 | 36.00 | 36.00 | 36.00 | 39.00 | | | | |

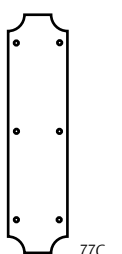

| Decorative (.050" Thick) | | | | | | | | | |
|--------------------------|----------------|-------------------|----------|-------------------|--|--|--|--|--|
| Part | 3/605 4/606 | 10/612 10B/613 | 10BE/BSP | 26/625 26D/626 | | | | | |
| 76B | 91.00 | 102.00 | 93.00 | 97.00 | | | | | |
| 76C | 100.00 | 108.00 | 101.00 | 104.00 | | | | | |
| 77B | 91.00 | 102.00 | 93.00 | 97.00 | | | | | |
| 77C | 100.00 | 108.00 | 101.00 | 104.00 | | | | | |

See page 12 for standard locations and sizes of Cylinder Cutouts (CFC) and Thumbturn Cutouts (CFTT), engraving and pricing.

ASSA ABLOY

Opening Solutions

The global leader in door opening solutions

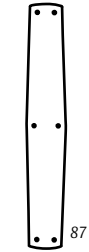
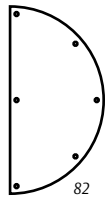

Push Plates (con't)

| .050" Thick | | | | | | | | | |
|-------------|--------|----------------|-------------------|----------|-------------------|---------|--------|--------|--------|
| Part | 28/628 | 3/605 4/606 | 10/612 10B/613 | 10BE/BSP | 26/625 26D/626 | 32D/630 | 32/629 | 32DMS | 32D316 |
| 80 | 88.00 | 144.00 | 159.00 | 105.00 | 153.00 | 83.00 | 109.00 | 102.00 | 131.00 |
| 81 | 93.00 | 151.00 | 163.00 | 114.00 | 159.00 | 92.00 | 121.00 | 143.00 | 140.00 |
| 82 | 97.00 | 161.00 | 178.00 | 123.00 | 172.00 | 98.00 | 128.00 | 121.00 | 146.00 |
| 84 | 152.00 | 255.00 | 274.00 | 208.00 | 265.00 | 168.00 | 198.00 | 187.00 | 216.00 |
| 85 | 57.00 | 106.00 | 108.00 | 74.00 | 104.00 | 68.00 | | 87.00 | |
| 86 | 82.00 | 125.00 | 131.00 | 103.00 | 125.00 | 81.00 | | 100.00 | |
| .125" Thick | | | | | | | | | |
| 87 | 145.00 | 297.00 | 319.00 | 244.00 | 308.00 | 198.00 | 236.00 | 221.00 | |

See page 12 for standard locations and sizes of Cylinder Cutouts (CFC) and Thumbturn Cutouts (CFTT), engraving and pricing.

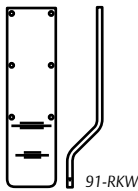
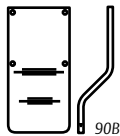
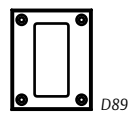

Flush Pulls

| Heavy Duty Security - Cast Brass | | | | | | | | | | | | |
|----------------------------------|--------|---------|--|--|----------|--|--|--|--|--|--|--|
| Part | 4/606 | 26D/626 | | | 10BE/BSP | | | | | | | |
| D89 | 208.00 | 135.00 | | | 171.00 | | | | | | | |

| Cylinder Pulls - .125" Thick | | | | | | | | | | | | | |
|------------------------------|--------|--------|-------|--------|---------|----------|---------|--------|---------|--------|--------|--------|-------|
| Part | 28/628 | 3/605 | 4/606 | 10/612 | 10B/613 | 10BE/BSP | 26D/626 | 26/625 | 32D/630 | 32/629 | 32DMS | 32D316 | 32316 |
| 90 | 72.00 | 81.00 | 81.00 | 85.00 | 85.00 | 91.00 | 72.00 | 91.00 | 69.00 | | 120.00 | | |
| 90B | 96.00 | 116.00 | | | 122.00 | 109.00 | 101.00 | | 90.00 | | 116.00 | | |

| Combination Pulls - .125" Thick - See page 12 for standard locations and sizes of Cylinder Cutouts (CFC) and Thumbturn Cutouts (CFTT), engraving and pricing. | | | | | | | | | | | | | |
|---|--------|--------|--------|--------|---------|----------|---------|--------|---------|--------|--------|--------|-------|
| Part | 28/628 | 3/605 | 4/606 | 10/612 | 10B/613 | 10BE/BSP | 26D/626 | 26/625 | 32D/630 | 32/629 | 32DMS | 32D316 | 32316 |
| 91-RKW | 80.00 | 136.00 | 136.00 | 144.00 | 144.00 | 107.00 | 131.00 | 142.00 | 76.00 | | 107.00 | | |
| 92-RKW | 125.00 | 199.00 | | | 208.00 | 161.00 | 201.00 | | 127.00 | | 150.00 | | |
| 93-RKW | 188.00 | 350.00 | 350.00 | 373.00 | 373.00 | 297.00 | 359.00 | 359.00 | 232.00 | 232.00 | 269.00 | | |

| Flush Pulls | | | | | | | | | | | | | |
|--------------|--|--------|--------|--------|--------|--------|--------|--------|--------|--------|--------|--------|--------|
| 94 | | 113.00 | 113.00 | 113.00 | 113.00 | 109.00 | 111.00 | 113.00 | 46.00 | 115.00 | 98.00 | 112.00 | 154.00 |
| 94BTB (pair) | | 232.00 | 232.00 | 232.00 | 232.00 | 228.00 | 225.00 | 232.00 | 97.00 | 236.00 | 202.00 | 231.00 | 314.00 |
| 94C | | 124.00 | 124.00 | 124.00 | 124.00 | 113.00 | 120.00 | 124.00 | 50.00 | 119.00 | 102.00 | 118.00 | 159.00 |
| 94L | | 183.00 | | | 191.00 | 130.00 | 183.00 | | 100.00 | 132.00 | 117.00 | 138.00 | 182.00 |
| 94P | | 161.00 | | | 176.00 | 113.00 | 170.00 | | 85.00 | 119.00 | 102.00 | 118.00 | 159.00 |
| 94P x 94L | | 347.00 | | | 370.00 | 246.00 | 356.00 | | 188.00 | 255.00 | 222.00 | 259.00 | 344.00 |

| Dead Lock Pulls - For Barrier Free grip specify BF94DLL or BF94DLS. Used with dead bolt lock. 1 1/4" cylinder hole is standard. | | | | | | | | | | | | | |
|---|--|--------|--|--|--------|--------|--------|--|--------|--------|--------|--------|--------|
| 94DLL | | 278.00 | | | 278.00 | 253.00 | 265.00 | | 185.00 | 228.00 | 228.00 | 255.00 | 302.00 |
| 94DLS | | 231.00 | | | 231.00 | 214.00 | 224.00 | | 145.00 | 191.00 | 191.00 | 214.00 | 255.00 |

| Cast Brass - Fasteners concealed in cup. | | | | | | | | | | | | | |
|--|--|-------|-------|-------|-------|--------|-------|-------|--|--|--|--|--|
| 95A | | 35.20 | 47.70 | 38.40 | 39.00 | 81.00 | 37.60 | 47.70 | | | | | |
| 95B | | 39.00 | 50.00 | 41.50 | 41.50 | 86.00 | 40.20 | 50.00 | | | | | |
| 95R | | 85.00 | 85.00 | 89.00 | 89.00 | 113.00 | 87.00 | 89.00 | | | | | |

| Flush Pull - .125" Thick - See page 12 for standard locations and sizes of Cylinder Cutouts (CFC) and Thumbturn Cutouts (CFTT), engraving and pricing. | | | | | | | | | | | | | |
|--|--|--------|--|--|--------|--------|--------|--|--------|--|--------|--|--|
| 96 | | 226.00 | | | 242.00 | 234.00 | 235.00 | | 139.00 | | 211.00 | | |

| Barrier Free | | | | | | | | | | | | | |
|--------------|--|--------|--|--|--------|--------|--------|--|--------|--|--------|--|--|
| BF97 | | 294.00 | | | 311.00 | 260.00 | 300.00 | | 155.00 | | 236.00 | | |
| BF97L | | 348.00 | | | 368.00 | 319.00 | 355.00 | | 217.00 | | 291.00 | | |

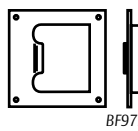
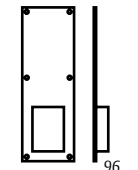
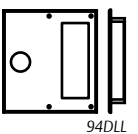
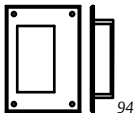

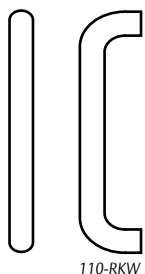

110-RKW

Straight Door Pulls & Door Pull Sets

| Straight Door Pulls & Door Pull Sets | | | | | | | | | | | | | |
|--------------------------------------|--------|--------------------|----------------|--------|---------|----------|---------|--------|---------|--------|--------|--------|--------|
| Part | 28/628 | 313/710 315/711 | 3/605 4/606 | 10/612 | 10B/613 | 10BE/BSP | 26D/626 | 26/625 | 32D/630 | 32/629 | 32DMS | 32D316 | 32316 |
| 102-RKW | | | 104.00 | 129.00 | 129.00 | 58.00 | 97.00 | 97.00 | 62.00 | 95.00 | 79.00 | | |
| 105 | 36.00 | 45.00 | 83.00 | 97.00 | 97.00 | 85.00 | 83.00 | 85.00 | 53.00 | 70.00 | 88.00 | 130.00 | 158.00 |
| 106-RKW | 36.00 | 45.00 | 83.00 | 100.00 | 104.00 | 91.00 | 85.00 | 89.00 | 53.00 | 72.00 | 90.00 | 133.00 | 162.00 |
| 107 | 39.00 | 45.00 | 97.00 | 113.00 | 115.00 | 130.00 | 97.00 | 100.00 | 55.00 | 79.00 | 99.00 | 137.00 | 165.00 |
| 108 | 41.00 | 55.00 | 108.00 | 127.00 | 131.00 | 117.00 | 111.00 | 113.00 | 66.00 | 90.00 | 121.00 | 156.00 | 183.00 |
| 109 | 68.00 | 75.00 | 161.00 | 206.00 | 206.00 | 287.00 | 153.00 | 153.00 | 107.00 | 132.00 | 125.00 | 154.00 | 186.00 |
| 110-RKW | 55.00 | 66.00 | 163.00 | 193.00 | 197.00 | 176.00 | 163.00 | 170.00 | 103.00 | 128.00 | 188.00 | 244.00 | 275.00 |
| 111A | 72.00 | 80.00 | 221.00 | 308.00 | 308.00 | 192.00 | 215.00 | 215.00 | 165.00 | 191.00 | 184.00 | 236.00 | 263.00 |
| 111 | 57.00 | 68.00 | 181.00 | 217.00 | 224.00 | 196.00 | 178.00 | 185.00 | 116.00 | 140.00 | 210.00 | 271.00 | 302.00 |
| 112 | 59.00 | 72.00 | 199.00 | 244.00 | 248.00 | 222.00 | 197.00 | 206.00 | 128.00 | 151.00 | 224.00 | 302.00 | 337.00 |
| 118 | 103.00 | 114.00 | 357.00 | 448.00 | 448.00 | 295.00 | 346.00 | 346.00 | 241.00 | 285.00 | 278.00 | 365.00 | 390.00 |

See page 34 for mounting selection and charges. NOTE: For BF Barrier Free projection on applicable straight door pulls add: \$9.50 each list. Add \$113.00 for knurling — round pulls only.

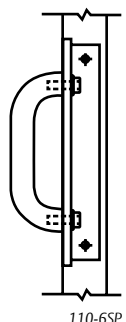

110-6SP

Security Door Pull

| Security Door Pull | | | |
|--------------------|----------|---------|--------|
| Part | 10BE/BSP | 32D/630 | 32DMS |
| 110-6SP | 515.00 | 401.00 | 505.00 |

For use on security hollow metal doors with reinforcing plate and access hole cover plate with *TORX® - security torx screws — all to be supplied by door manufacturer.

Tubular Door Pulls & Door Pull Sets

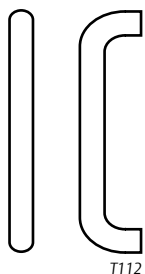

T112

| Tubular Straight Door Pulls — Type 1 Thru-Bolt Mount for 1 3/4" Door. | | | | | | |
|---|----------------|-------------------|----------|---------|--------|--------|
| Part | 3/605 4/606 | 10/612 10B/613 | 10BE/BSP | 32D/630 | 32/629 | 32DMS |
| T110 | 241.00 | 245.00 | 169.00 | 139.00 | 170.00 | 168.00 |
| T111A | 252.00 | 260.00 | 173.00 | 143.00 | 174.00 | 172.00 |
| T111 | 252.00 | 260.00 | 173.00 | 143.00 | 174.00 | 172.00 |
| T112 | 264.00 | 271.00 | 183.00 | 149.00 | 185.00 | 176.00 |
| T118 | 297.00 | 302.00 | 198.00 | 170.00 | 214.00 | 195.00 |

*Torx® is a registered trademark of Textron Inc.

ASSA ABLOY

Opening Solutions

The global leader in door opening solutions

USA & Canada Prices Effective June 3, 2019

Copyright © 2019, ASSA ABLOY Accessories and Door Controls Group, Inc. All rights reserved. Reproduction in whole or in part without the express written permission of ASSA ABLOY Accessories and Door Controls Group, Inc. is prohibited.

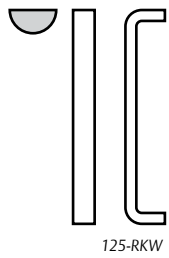

125-RKW

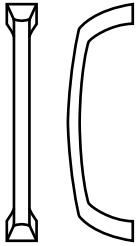

137

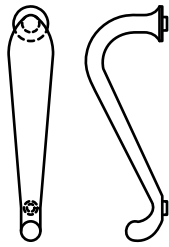

147

Door Pulls

| Pulls - Engraving available vertically. See page 12 for pricing. | | | | | | | | | | |
|--|--------|----------------|--------|---------|----------|---------|--------|---------|--------|--------|
| Part | 28/628 | 3/605 4/606 | 10/612 | 10B/613 | 10BE/BSP | 26D/626 | 26/625 | 32D/630 | 32/629 | 32DMS |
| 120 | 204.00 | 420.00 | 461.00 | 461.00 | 293.00 | 448.00 | 448.00 | 250.00 | 246.00 | 274.00 |
| 121 | 215.00 | 448.00 | 488.00 | 488.00 | 313.00 | 473.00 | 473.00 | 261.00 | 266.00 | 289.00 |
| 122-RKW | 59.00 | 136.00 | 181.00 | 181.00 | 91.00 | 172.00 | 172.00 | 77.00 | 77.00 | 103.00 |
| 123 | 68.00 | 159.00 | 201.00 | 201.00 | 109.00 | 195.00 | 195.00 | 95.00 | 95.00 | 118.00 |
| 125-RKW | 68.00 | 144.00 | 153.00 | 153.00 | 123.00 | 149.00 | 149.00 | 103.00 | 103.00 | 128.00 |
| 126-RKW | 72.00 | 170.00 | 193.00 | 193.00 | 137.00 | 183.00 | 183.00 | 116.00 | 116.00 | 138.00 |
| Cast Pulls | | | | | | | | | | |
| 130-RKW | 40.80 | 81.00 | 81.00 | 85.00 | 76.00 | 74.00 | 89.00 | 99.00 | 136.00 | 138.00 |
| 131-RKW | 40.80 | 81.00 | 81.00 | 89.00 | 76.00 | 77.00 | 91.00 | 99.00 | 136.00 | 138.00 |
| 132-RKW | 59.00 | 89.00 | | 100.00 | 111.00 | 95.00 | | 101.00 | | 125.00 |
| D133-RKW | | 134.00 | | 233.00 | 137.00 | 151.00 | | 112.00 | 121.00 | 142.00 |
| 134-RKW | | 131.00 | | 140.00 | 150.00 | 136.00 | | | | |
| 137 | | 106.00 | | 115.00 | 125.00 | 111.00 | | 107.00 | 105.00 | 130.00 |
| 137L | | 212.00 | | 212.00 | 230.00 | 206.00 | | | | |
| 138 | 88.00 | 149.00 | | 165.00 | 179.00 | 161.00 | | | | |
| 139 | 88.00 | 149.00 | | 165.00 | 179.00 | 161.00 | | | | |
| Cast Pulls - See page 34 for mounting selection and charges. | | | | | | | | | | |
| 147 | 43.10 | 170.00 | 170.00 | 170.00 | 184.00 | 165.00 | | | | |
| 147L | | 287.00 | 341.00 | 341.00 | 369.00 | 333.00 | | | | |
| 148 | | 255.00 | 255.00 | 255.00 | 277.00 | 248.00 | | | | |
| 149 | | 314.00 | 314.00 | 314.00 | 340.00 | 305.00 | | | | |

90° Offset Door Pulls & Door Pull Sets

| 90° Offset Door Pulls & Door Pull Sets | | | | | | | | | | | | |
|---|--------|--------------------|----------------|-------------------|----------|---------|--------|---------|--------|--------|--------|--------|
| Part | 28/628 | 313/710 315/711 | 3/605 4/606 | 10/612 10B/613 | 10BE/BSP | 26D/626 | 26/625 | 32D/630 | 32/629 | 32DMS | 32D316 | 32316 |
| BF150 | 91.00 | 114.00 | 219.00 | 269.00 | 176.00 | 212.00 | 212.00 | 151.00 | 196.00 | 182.00 | 230.00 | 260.00 |
| BF151 | 102.00 | 122.00 | 237.00 | 133.00 | 190.00 | 231.00 | 231.00 | 163.00 | 202.00 | 188.00 | 242.00 | 269.00 |
| BF152 | 102.00 | 129.00 | 219.00 | 269.00 | 176.00 | 212.00 | 212.00 | 167.00 | 196.00 | 191.00 | 253.00 | 288.00 |
| BF156 | 82.00 | 95.00 | 233.00 | 297.00 | 261.00 | 237.00 | 246.00 | 142.00 | 175.00 | 254.00 | 369.00 | 409.00 |
| BF157A | 82.00 | 97.00 | 251.00 | 321.00 | 287.00 | 255.00 | 263.00 | 158.00 | 193.00 | 278.00 | 400.00 | 435.00 |
| BF157 | 82.00 | 97.00 | 251.00 | 321.00 | 287.00 | 255.00 | 263.00 | 158.00 | 193.00 | 268.00 | 384.00 | 418.00 |
| BF158 | 88.00 | 99.00 | 269.00 | 344.00 | 307.00 | 274.00 | 282.00 | 169.00 | 204.00 | 301.00 | 429.00 | 462.00 |
| BF159 | 129.00 | 144.00 | 349.00 | 410.00 | 376.00 | 355.00 | 365.00 | 237.00 | 287.00 | 367.00 | 369.00 | 464.00 |
| Offset Door Pulls - Type 17 Concealed Mount for 1 3/4" Aluminum Door. (Double Cone Head) | | | | | | | | | | | | |
| BF156C17 | 104.00 | 117.00 | 261.00 | 322.00 | 287.00 | 266.00 | 274.00 | 169.00 | 204.00 | 281.00 | 226.00 | 272.00 |
| BF157AC17 | 107.00 | 119.00 | 279.00 | 348.00 | 310.00 | 282.00 | 292.00 | 182.00 | 222.00 | 304.00 | 244.00 | 297.00 |
| BF157C17 | 107.00 | 119.00 | 279.00 | 348.00 | 310.00 | 282.00 | 292.00 | 182.00 | 222.00 | 182.00 | 244.00 | 297.00 |
| BF158C17 | 109.00 | 122.00 | 298.00 | 373.00 | 332.00 | 301.00 | 310.00 | 194.00 | 234.00 | 326.00 | 259.00 | 313.00 |
| BF159C17 | 153.00 | 171.00 | 385.00 | 451.00 | 402.00 | 392.00 | 404.00 | 262.00 | 314.00 | 395.00 | 350.00 | 421.00 |
| Tubular Offset Door Pulls - Type 1 Thru-Bolt Mount for 1 3/4" Door. | | | | | | | | | | | | |
| TBF156 | | | 278.00 | 285.00 | 177.00 | | | 145.00 | 208.00 | 174.00 | | |
| TBF157A | | | 289.00 | 295.00 | 185.00 | | | 149.00 | 217.00 | 179.00 | | |
| TBF157 | | | 289.00 | 295.00 | 185.00 | | | 149.00 | 217.00 | 179.00 | | |
| TBF158 | | | 297.00 | 306.00 | 189.00 | | | 155.00 | 222.00 | 183.00 | | |
| TBF159 | | | 369.00 | 328.00 | 246.00 | | | 159.00 | 231.00 | 176.00 | | |
| Tubular Offset Door Pull - Type 17 Concealed Mount for 1 3/4" Aluminum Door. (Double Cone Head) | | | | | | | | | | | | |
| TBF156C17 | | | 350.00 | 357.00 | 232.00 | | | 191.00 | 260.00 | 219.00 | | |
| TBF157AC17 | | | 363.00 | 367.00 | 237.00 | | | 195.00 | 264.00 | 224.00 | | |
| TBF157C17 | | | 363.00 | 367.00 | 237.00 | | | 195.00 | 264.00 | 224.00 | | |
| TBF158C17 | | | 369.00 | 374.00 | 246.00 | | | 201.00 | 268.00 | 233.00 | | |
| TBF159C17 | | | 411.00 | 423.00 | 285.00 | | | 235.00 | 306.00 | 271.00 | | |

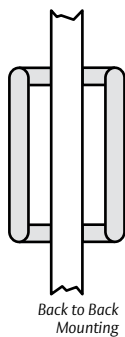
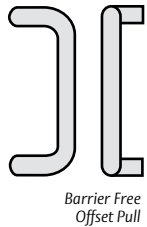

See page 34 for mounting selection and charges. Back to Back Mounting Available: Specify by adding "BTB" to end of part number. For pricing, double the pull price and add \$24.30.

45° Offset Door Pulls

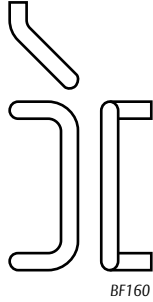

| Part | 28/628 | 313/710 315/711 | 3/605 4/606 | 10/612 10B/613 | 10BE/BSP | 26/625 26D/626 | 32D/630 | 32/629 | 32DMS | 32D316 | 32316 |
|---------------|--------|--------------------|----------------|-------------------|----------|-------------------|---------|--------|--------|--------|--------|
| BF160 | 91.00 | 114.00 | 219.00 | 269.00 | 176.00 | 212.00 | 151.00 | 196.00 | 182.00 | 230.00 | 260.00 |
| BF161 | 102.00 | 122.00 | 237.00 | 291.00 | 190.00 | 231.00 | 163.00 | 202.00 | 188.00 | 242.00 | 269.00 |
| BF162 | 91.00 | 122.00 | 248.00 | 291.00 | 202.00 | 212.00 | 167.00 | 196.00 | 191.00 | 230.00 | 288.00 |
| BF166 | 109.00 | 129.00 | 305.00 | 369.00 | 311.00 | 297.00 | 268.00 | 291.00 | 294.00 | 341.00 | 388.00 |
| BF167A | 122.00 | 141.00 | 321.00 | 386.00 | 322.00 | 312.00 | 278.00 | 303.00 | 305.00 | 353.00 | 388.00 |
| BF167 | 122.00 | 141.00 | 321.00 | 386.00 | 335.00 | 312.00 | 287.00 | 309.00 | 314.00 | 372.00 | 402.00 |
| BF168 | 136.00 | 154.00 | 341.00 | 407.00 | 356.00 | 333.00 | 291.00 | 334.00 | 336.00 | 398.00 | 429.00 |
| BF169 | 168.00 | 196.00 | 414.00 | 473.00 | 429.00 | 403.00 | 353.00 | 392.00 | 406.00 | 481.00 | 511.00 |

See page 34 for mounting selection and charges.

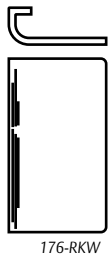

Offset Door Pulls

| Part | 28/628 | 313/710 315/711 | 3/605 4/606 | 10/612 10B/613 | 10BE/BSP | 32D/630 | 32DMS |
|----------------|--------|--------------------|----------------|-------------------|----------|---------|--------|
| 176-RKW | 293.00 | 316.00 | 819.00 | 918.00 | 507.00 | 435.00 | 456.00 |
| 177 | 327.00 | 345.00 | 918.00 | 1,010.00 | 608.00 | 520.00 | 540.00 |
| 185 | 354.00 | 408.00 | 1,282.00 | 1,282.00 | 1,116.00 | 952.00 | 967.00 |

Call factory for engraving and pricing.

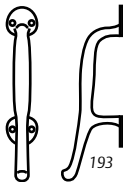

Hospital Door Pull

| Part | 3/605 4/606 | 10/612 10B/613 | 10BE/BSP | 26/625 26D/626 | 32D/630 | 32DMS |
|------------|----------------|-------------------|----------|-------------------|---------|--------|
| 193 | 129.00 | 136.00 | 145.00 | 131.00 | 123.00 | 140.00 |

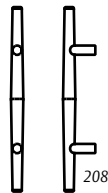

Wooden Door Pull

| Part | 28/628 | 313/710 315/711 | 3/605 4/606 | 10/612 10B/613 | 10BE/BSP | 26/625 26D/626 | 32D/630 | 32/629 | 32DMS |
|------------|--------|--------------------|----------------|-------------------|----------|-------------------|---------|--------|--------|
| 208 | 497.00 | 497.00 | 464.00 | 464.00 | 510.00 | 448.00 | 452.00 | 465.00 | 478.00 |

Wood available in Sanded - Unfinished, Oil, or Clear Coated. See page 34 for mounting details.

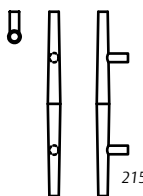

Tapered Door Pull

| Part | 28/628 | 313/710 315/711 | 3/605 4/606 | 10/612 10B/613 | 10BE/BSP | 26/625 26D/626 | 32D/630 | 32/629 | 32DMS |
|-------------|--------|--------------------|----------------|-------------------|----------|-------------------|----------|----------|----------|
| 215 | 527.00 | 558.00 | 864.00 | 967.00 | 727.00 | 938.00 | 594.00 | 692.00 | 645.00 |
| 215L | 701.00 | 739.00 | 1,558.00 | 1,704.00 | 1,240.00 | 1,650.00 | 1,014.00 | 1,200.00 | 1,075.00 |

Larger sizes available upon request. See page 34 for mounting details.

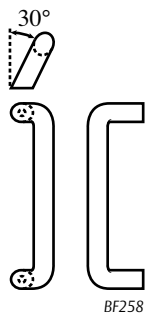

Heavy Duty Offset Pulls

| Heavy Duty Offset Pulls | | | | | | | | | | | |
|-------------------------|--------|--------------------|----------------|-------------------|----------|-------------------|---------|--------|--------|--------|--------|
| Part | 28/628 | 313/710 315/711 | 3/605 4/606 | 10/612 10B/613 | 10BE/BSP | 26/625 26D/626 | 32D/630 | 32/629 | 32DMS | 32D316 | 32316 |
| BF257 | 318.00 | 345.00 | 766.00 | 880.00 | 602.00 | 746.00 | 515.00 | 631.00 | 553.00 | 655.00 | 727.00 |
| BF258 | 345.00 | 377.00 | 825.00 | 936.00 | 653.00 | 800.00 | 559.00 | 676.00 | 602.00 | 696.00 | 838.00 |
| BF259 | 356.00 | 392.00 | 936.00 | 1,076.00 | 720.00 | 908.00 | 616.00 | 732.00 | 656.00 | 759.00 | 838.00 |
| BF260 | 385.00 | 421.00 | 1,076.00 | 1,248.00 | 790.00 | 1,044.00 | 649.00 | 794.00 | 746.00 | 823.00 | 897.00 |

Supplied with 3/8" -16 Thru Bolts.

Vandal Resistant Trim

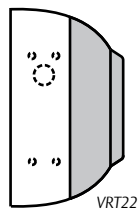

| Vandal Resistant Trim | | | |
|-----------------------|----------|---------|--------|
| Part | 10BE/BSP | 32D/630 | 32DMS |
| VRT12 | 589.00 | 498.00 | 567.00 |
| VRT14 | 591.00 | 403.00 | 569.00 |
| VRT16 | 507.00 | 356.00 | 488.00 |
| VRT22 | | 605.00 | |
| VRT24 | | 510.00 | |
| VRT26 | | 457.00 | |

Specify Exit Device make and model to thru bolt directly to device.

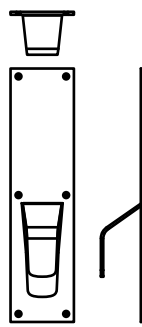

Vandal Resistant Pull

| Vandal Resistant Pull | | |
|-----------------------|----------|---------|
| Part | 10BE/BSP | 32D/630 |
| VRP30 | 276.00 | 266.00 |

Set up charge for custom powder will apply. Specify Exit Device make and model to thru bolt directly to device (add on price will occur.)

Pull Plates

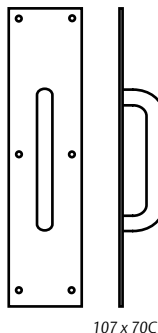

| Pull Plates | | | | | | | | | | | | |
|-------------|--------|--------|--------|--------|---------|----------|---------|--------|---------|--------|--------|--------|
| Part | 28/628 | 3/605 | 4/606 | 10/612 | 10B/613 | 10BE/BSP | 26D/626 | 26/625 | 32D/630 | 32/629 | 32DMS | 32D316 |
| 102 x 70B | | 111.00 | 111.00 | 116.00 | 116.00 | 106.00 | 109.00 | 114.00 | 60.00 | 83.00 | 89.00 | |
| 102 x 70C | | 121.00 | 121.00 | 126.00 | 126.00 | 112.00 | 118.00 | 121.00 | 60.00 | 89.00 | 89.00 | |
| 105 x 70B | 59.00 | 135.00 | 135.00 | 148.00 | 148.00 | 132.00 | 135.00 | 139.00 | 75.00 | 97.00 | 130.00 | 177.00 |
| 105 x 70C | 62.00 | 141.00 | 141.00 | 158.00 | 158.00 | 140.00 | 143.00 | 146.00 | 75.00 | 101.00 | 135.00 | 182.00 |
| 106 x 70B | 59.00 | 137.00 | 137.00 | 152.00 | 156.00 | 140.00 | 137.00 | 141.00 | 75.00 | 99.00 | 132.00 | 180.00 |
| 106 x 70C | 62.00 | 143.00 | 143.00 | 160.00 | 164.00 | 146.00 | 146.00 | 148.00 | 75.00 | 104.00 | 137.00 | 184.00 |
| 107 x 70B | 59.00 | 146.00 | 146.00 | 164.00 | 167.00 | 148.00 | 146.00 | 150.00 | 77.00 | 106.00 | 137.00 | 182.00 |
| 107 x 70C | 62.00 | 152.00 | 152.00 | 175.00 | 175.00 | 155.00 | 156.00 | 160.00 | 69.00 | 110.00 | 141.00 | 187.00 |
| 110 x 70B | 76.00 | 212.00 | 212.00 | 246.00 | 250.00 | 223.00 | 212.00 | 219.00 | 124.00 | 155.00 | 227.00 | 292.00 |
| 110 x 70C | 76.00 | 221.00 | 221.00 | 253.00 | 258.00 | 229.00 | 221.00 | 226.00 | 126.00 | 159.00 | 230.00 | 297.00 |
| 111 x 70B | 78.00 | 231.00 | 231.00 | 269.00 | 274.00 | 245.00 | 228.00 | 235.00 | 135.00 | 168.00 | 247.00 | 320.00 |
| 111 x 70C | 80.00 | 237.00 | 237.00 | 276.00 | 285.00 | 252.00 | 235.00 | 244.00 | 137.00 | 172.00 | 251.00 | 320.00 |
| 122 x 70B | 62.00 | 128.00 | 128.00 | 141.00 | 143.00 | 126.00 | 137.00 | 141.00 | 93.00 | 112.00 | 124.00 | 136.00 |
| 122 x 70C | 64.00 | 139.00 | 139.00 | 148.00 | 150.00 | 134.00 | 143.00 | 148.00 | 95.00 | 97.00 | 124.00 | 138.00 |
| 123 x 70B | 66.00 | 160.00 | 160.00 | 162.00 | 162.00 | 144.00 | 162.00 | 167.00 | 101.00 | 106.00 | 132.00 | 147.00 |
| 123 x 70C | 68.00 | 173.00 | 173.00 | 173.00 | 173.00 | 150.00 | 171.00 | 175.00 | 104.00 | 106.00 | 132.00 | 149.00 |
| 125 x 70B | 66.00 | 143.00 | 143.00 | 148.00 | 148.00 | 132.00 | 141.00 | 150.00 | 108.00 | 190.00 | 216.00 | 243.00 |
| 125 x 70C | 68.00 | 152.00 | 152.00 | 156.00 | 156.00 | 140.00 | 148.00 | 160.00 | 110.00 | 112.00 | 139.00 | 156.00 |
| 126 x 70B | 66.00 | 156.00 | 156.00 | 160.00 | 160.00 | 142.00 | 152.00 | 162.00 | 126.00 | 128.00 | 152.00 | 171.00 |
| 126 x 70C | 68.00 | 164.00 | 164.00 | 167.00 | 167.00 | 148.00 | 160.00 | 171.00 | 126.00 | 130.00 | 155.00 | 175.00 |
| 132 x 70B | 55.00 | 105.00 | 107.00 | 109.00 | 111.00 | 99.00 | 105.00 | 121.00 | 91.00 | 93.00 | 119.00 | |
| 132 x 70C | 57.00 | 111.00 | 114.00 | 116.00 | 118.00 | 106.00 | 111.00 | 132.00 | 91.00 | 93.00 | 119.00 | |
| 137 x 70B | 64.00 | 124.00 | 126.00 | 126.00 | 128.00 | 114.00 | 124.00 | 128.00 | 110.00 | 112.00 | 139.00 | |
| 137 x 70C | 68.00 | 132.00 | 137.00 | 135.00 | 137.00 | 122.00 | 135.00 | 137.00 | 110.00 | 116.00 | 141.00 | |

Barrier Free - Available in 2 1/2" clearance add \$9.50 list (excludes 132 and 137).

ASSA ABLOY

Opening Solutions

The global leader in door opening solutions

Decorative Pull Plates

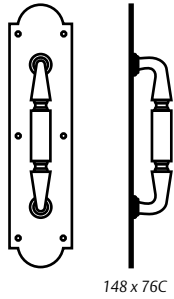

148 x 76C

| Decorative Pull Plates | | | | |
|------------------------|----------------|-------------------|----------|-------------------|
| Part | 3/605 4/606 | 10/612 10B/613 | 10BE/BSP | 26/625 26D/626 |
| 147 x 76B | 285.00 | 299.00 | 323.00 | 287.00 |
| 147 x 76C | 297.00 | 306.00 | 331.00 | 422.00 |
| 147 x 77B | 285.00 | 299.00 | 323.00 | 287.00 |
| 147 x 77C | 297.00 | 306.00 | 331.00 | 422.00 |
| 148 x 76B | 374.00 | 385.00 | 414.00 | 374.00 |
| 148 x 76C | 385.00 | 397.00 | 429.00 | 381.00 |
| 148 x 77B | 374.00 | 385.00 | 414.00 | 374.00 |
| 148 x 77C | 385.00 | 397.00 | 429.00 | 381.00 |

Tubular Pull Plates

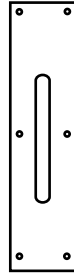

T110 x 70C

| Tubular Pull Plates | | | | | | |
|---------------------|----------------|-------------------|--------------|---------|--------|--------|
| Part | 3/605 4/606 | 10/612 10B/613 | 10BE/ BSP | 32D/630 | 32/629 | 32DMS |
| T110 x 70B | 291.00 | 314.00 | 212.00 | 174.00 | 221.00 | 201.00 |
| T110 x 70C | 303.00 | 322.00 | 216.00 | 178.00 | 226.00 | 205.00 |
| T111 x 70B | 309.00 | 325.00 | 216.00 | 178.00 | 230.00 | 205.00 |
| T111 x 70C | 316.00 | 334.00 | 228.00 | 187.00 | 235.00 | 214.00 |

Corner Guards



290

| Corner Guards | | | | |
|---------------|---------------|----------------|-------------------|---------|
| Part | Size | 3/605 4/606 | 10/612 10B/613 | 32D/630 |
| 290 | 2" x 2" x 40" | 181.00 | 217.00 | 118.00 |
| | 2" x 2" x 48" | 192.00 | 230.00 | 125.00 |
| | 3" x 3" x 40" | 207.00 | 248.00 | 135.00 |
| | 3" x 3" x 48" | 225.00 | 269.00 | 146.00 |
| 291 | 2" x 2" x 40" | 197.00 | 236.00 | 128.00 |
| | 2" x 2" x 48" | 207.00 | 248.00 | 135.00 |
| | 3" x 3" x 40" | 222.00 | 267.00 | 145.00 |
| | 3" x 3" x 48" | 240.00 | 287.00 | 157.00 |



295

| Corner Guards | | | | | | |
|---------------|---------------|----------------|-------------------|--------------|---------|--------|
| Part | Size | 3/605 4/606 | 10/612 10B/613 | 10BE/ BSP | 32D/630 | 32DMS |
| 295 | 2" x 2" x 40" | 145.00 | 174.00 | 132.00 | 95.00 | 133.00 |
| | 2" x 2" x 48" | 157.00 | 187.00 | 143.00 | 102.00 | 144.00 |
| | 3" x 3" x 40" | 172.00 | 206.00 | 158.00 | 112.00 | 160.00 |
| | 3" x 3" x 48" | 188.00 | 227.00 | 172.00 | 123.00 | 174.00 |
| 296 | 2" x 2" x 40" | 167.00 | 200.00 | 153.00 | 109.00 | 155.00 |
| | 2" x 2" x 48" | 178.00 | 213.00 | 163.00 | 116.00 | 165.00 |
| | 3" x 3" x 40" | 194.00 | 232.00 | 177.00 | 126.00 | 179.00 |
| | 3" x 3" x 48" | 210.00 | 252.00 | 193.00 | 137.00 | 195.00 |

Other lengths available up to 96" and leg widths up to 6". Part number 290 and 291 includes self-adhesive mounting.

Mortised Door Edges (UL Approved)

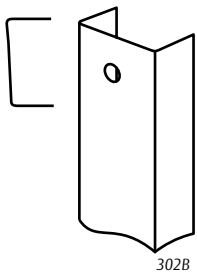

302B

| Mortised Door Edges | | | | | | | |
|---------------------|-----------|----------------|-------------------|----------|---------|--------|--------|
| Part | Height | 3/605 4/606 | 10/612 10B/613 | 10BE/BSP | 32D/630 | 32DMS | 32D316 |
| 300 | Up to 42" | 211.00 | 228.00 | 142.00 | 115.00 | 139.00 | 163.00 |
| | 43" - 66" | 324.00 | 351.00 | 210.00 | 172.00 | 206.00 | 251.00 |
| | 67" - 96" | 478.00 | 508.00 | 291.00 | 243.00 | 287.00 | 363.00 |
| 301 | Up to 42" | 211.00 | 228.00 | 142.00 | 115.00 | 139.00 | 163.00 |
| | 43" - 66" | 324.00 | 351.00 | 210.00 | 172.00 | 206.00 | 251.00 |
| | 67" - 96" | 478.00 | 508.00 | 291.00 | 243.00 | 287.00 | 363.00 |
| 302 | Up to 42" | 239.00 | 255.00 | 163.00 | 134.00 | 161.00 | 180.00 |
| | 43" - 66" | 351.00 | 384.00 | 242.00 | 202.00 | 236.00 | 281.00 |
| | 67" - 96" | 522.00 | 552.00 | 334.00 | 287.00 | 328.00 | 410.00 |
| 302B | Up to 42" | 239.00 | 255.00 | 163.00 | 134.00 | 161.00 | 180.00 |
| | 43" - 66" | 351.00 | 384.00 | 242.00 | 202.00 | 236.00 | 281.00 |
| | 67" - 96" | 522.00 | 552.00 | 334.00 | 287.00 | 328.00 | 410.00 |

Available in stainless steel, brass and bronze. UL Listed for fire rated doors. Add \$28.00 per edge - specify UL when ordering (300-UL). Includes Phillips Flat Head Sheet Metal Screw Fasteners. To defray set up costs, add 30% for less than 10 pieces. Add an additional \$25.80 for each cutout.

Non-Mortise Door Edges (UL Approved)

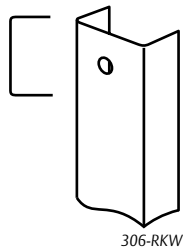

| Non-Mortise Door Edges | | | | | | | |
|------------------------|-----------|----------------|-------------------|----------|----------|----------|----------|
| Part | Height | 3/605 4/606 | 10/612 10B/613 | 10BE/BSP | 32D/630 | 32DMS | 32D316 |
| 304 | Up to 42" | 211.00 | 228.00 | 142.00 | 115.00 | 139.00 | 163.00 |
| | 43"- 66" | 324.00 | 351.00 | 210.00 | 172.00 | 206.00 | 251.00 |
| | 67"- 96" | 478.00 | 508.00 | 291.00 | 243.00 | 287.00 | 363.00 |
| 305 | Up to 42" | 211.00 | 228.00 | 142.00 | 115.00 | 139.00 | 163.00 |
| | 43"- 66" | 324.00 | 351.00 | 210.00 | 172.00 | 206.00 | 251.00 |
| | 67"- 96" | 478.00 | 508.00 | 291.00 | 243.00 | 287.00 | 363.00 |
| 306-RKW | Up to 42" | 239.00 | 255.00 | 163.00 | 134.00 | 161.00 | 180.00 |
| | 43"- 66" | 351.00 | 384.00 | 242.00 | 202.00 | 236.00 | 281.00 |
| | 67"- 96" | 522.00 | 552.00 | 334.00 | 287.00 | 328.00 | 410.00 |
| 306-AST | Up to 96" | 1,368.00 | 1,368.00 | 1,278.00 | 1,257.00 | 1,257.00 | 1,369.00 |
| 306B | Up to 42" | 239.00 | 255.00 | 163.00 | 134.00 | 161.00 | 180.00 |
| | 43"- 66" | 351.00 | 384.00 | 242.00 | 202.00 | 236.00 | 281.00 |
| | 67"- 96" | 522.00 | 552.00 | 334.00 | 287.00 | 328.00 | 410.00 |
| 306B-AST | Up to 96" | 1,368.00 | 1,368.00 | 1,278.00 | 1,257.00 | 1,257.00 | 1,295.00 |
| 307 | Up to 42" | 274.00 | 291.00 | 196.00 | 168.00 | 193.00 | 218.00 |
| | 43"- 66" | 412.00 | 444.00 | 298.00 | 257.00 | 291.00 | 343.00 |
| | 67"- 96" | 614.00 | 640.00 | 438.00 | 367.00 | 430.00 | 501.00 |

Available in stainless steel, brass and bronze. UL Listed for fire rated doors. Add \$28 per edge - specify UL when ordering (304-UL). Includes Phillips Flat Head Sheet Metal Screw Fasteners. To defray set up costs, add 30% for less than 10 pieces. Add an additional \$25.80 for each cutout.

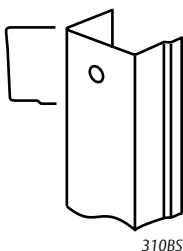

Overlapping Door Edges (UL Approved)

| Overlapping Door Edges | | | | | | | |
|------------------------|-----------|----------------|-------------------|----------|---------|--------|--------|
| Part | Height | 3/605 4/606 | 10/612 10B/613 | 10BE/BSP | 32D/630 | 32DMS | 32D316 |
| 308 | Up to 42" | 239.00 | 255.00 | 163.00 | 134.00 | 161.00 | 180.00 |
| 309 | Up to 42" | 239.00 | 255.00 | 163.00 | 134.00 | 161.00 | 180.00 |
| 310 | Up to 42" | 269.00 | 285.00 | 163.00 | 134.00 | 161.00 | 180.00 |
| 310B | Up to 42" | 269.00 | 285.00 | 163.00 | 134.00 | 161.00 | 180.00 |
| 310BS | Up to 42" | 269.00 | 285.00 | 163.00 | 134.00 | 161.00 | 180.00 |

Available in stainless steel, brass and bronze. UL Listed for fire rated doors. Add \$28 per edge - specify UL when ordering (308-UL). Includes Phillips Flat Head Sheet Metal Screw Fasteners. To defray set up costs, add 30% for less than 10 pieces. Add an additional \$25.80 for each cutout.

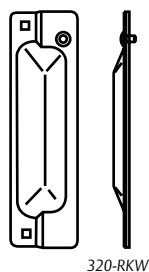

Latch Protectors

| Latch Protectors | | | | |
|------------------|--------|----------|---------|---------|
| Part | 2C/603 | 10BE/BSP | 26D/626 | 32D/630 |
| 320-RKW | 29.40 | 78.00 | | 53.00 |
| 320C | 29.40 | 78.00 | | 53.00 |
| 320CL | 29.40 | 78.00 | | 53.00 |
| 320CXL | | 78.00 | | 53.00 |
| 321 | 22.60 | 58.00 | | 39.10 |
| 322 | 20.60 | 58.00 | | 31.80 |
| 325 | | 133.00 | 92.00 | |
| 330 | | 140.00 | | 95.00 |

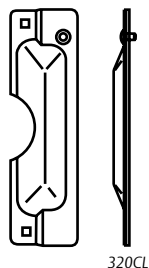

ASSA ABLOY

Opening Solutions

The global leader in door opening solutions

Stops

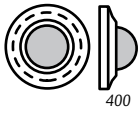

| Solid Cast Wall Stops - Rubber Bumper | | | | | | | |
|---------------------------------------|-------|----------------------------|----------|--------|---------|--------|--|
| Part | 3/605 | 4/606 10/612 10B/613 | 10BE/BSP | 15/619 | 26D/626 | 26/625 | |
| 400 | 17.10 | 22.00 | 24.30 | 22.00 | 14.70 | 27.40 | |
| 401 | 17.60 | 22.50 | 23.00 | 22.50 | 15.20 | 27.90 | |
| 402 | 18.40 | 23.30 | 23.90 | 23.30 | 16.10 | 29.00 | |
| 403 | 17.10 | 22.00 | 24.30 | 22.00 | 14.70 | 27.40 | |
| 404 | 17.60 | 22.50 | 24.80 | 22.50 | 15.20 | 27.90 | |
| 405 | 18.40 | 23.30 | 25.80 | 23.30 | 16.10 | 29.00 | |

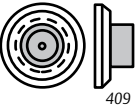

| Wrought Wall Stops - Rubber Bumper | | | | | | | |
|------------------------------------|----------------|--------|------|---------|--------|---------|--|
| Part | 3/605 4/606 | 10/612 | 10BE | 26D/626 | 26/625 | 32D/630 | |
| 406 | 7.40 | 7.40 | 8.40 | 7.40 | 7.70 | 4.70 | |
| 409 | 7.40 | 7.40 | 8.40 | 7.40 | 7.70 | 4.70 | |

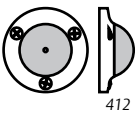

| Solid Cast Wall Stops - Rubber Bumper | | | | | | | |
|---------------------------------------|-------|----------------------------|----------|--------|---------|--------|--|
| Part | 3/605 | 4/606 10/612 10B/613 | 10BE/BSP | 15/619 | 26D/626 | 26/625 | |
| 412 | 25.20 | 27.10 | 62.00 | 27.10 | 23.30 | 26.20 | |
| 415 | 61.00 | 59.00 | 76.00 | 44.20 | 40.00 | 61.00 | |
| 416 | 25.20 | 27.10 | 62.00 | 27.20 | 23.30 | 26.20 | |

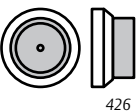

| Wrought Wall Stops - Rubber Bumper | | | | | | | |
|------------------------------------|-------|----------|---------|--|--|--|--|
| Part | 3/605 | 10BE/BSP | 32D/630 | | | | |
| 426 | 8.40 | 18.90 | 8.20 | | | | |

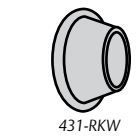

| Solid Cast Wall Stop - Rubber Bumper | | | | | | | |
|--------------------------------------|-----------------|-------|---------|----------|--------|---------|--|
| Part | 3/605 26/625 | 4/606 | 10B/613 | 10BE/BSP | 15/619 | 26D/626 | |
| 430-RKW | 14.10 | 15.70 | 15.10 | 17.40 | 22.50 | 11.70 | |



| Wall Stops - Rubber Bumper | | | |
|----------------------------|--|------|-------|
| Part | | Gray | White |
| 431-RKW | | 4.60 | |
| 432W | | | 4.30 |



| Dome Stops | | | | | | | | |
|------------|-------|-------|--------|---------|----------|--------|---------|--------|
| Part | 3/605 | 4/606 | 10/612 | 10B/613 | 10BE/BSP | 15/619 | 26D/626 | 26/625 |
| 440 | 11.20 | 11.90 | 13.80 | 12.50 | 15.80 | 17.10 | 10.30 | 11.70 |
| 441 | 12.80 | 12.50 | 14.40 | 13.10 | 17.30 | 15.70 | 11.70 | 12.50 |
| 441CU | 19.20 | 18.40 | 21.50 | 19.20 | 24.20 | | 17.00 | 18.10 |
| 441H | 19.80 | 19.80 | 21.50 | 21.50 | 25.50 | 23.10 | 16.00 | 20.30 |
| 442 | 13.30 | 13.30 | 14.10 | 15.20 | 18.60 | 19.00 | 13.10 | 13.60 |
| 443 | 14.40 | 14.10 | 16.30 | 15.20 | 18.00 | 17.30 | 12.50 | 14.70 |



| Cast Riser (for 440 & 441 Dome Stops) | | | | | | | | |
|---------------------------------------|-------|-------|------|------|------|--|------|------|
| Part | 3/605 | 4/606 | 7.00 | 7.00 | 8.40 | | 5.80 | 6.50 |
| 444 | 6.50 | 6.50 | 7.00 | 7.00 | 8.40 | | 5.80 | 6.50 |

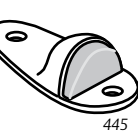

| Heavy Duty Door Stop | | | | | | | | | |
|----------------------|-------|-------|--------|---------|---------|----------|--------|--------|---------|
| Part | 3/605 | 4/606 | 10/612 | 10B/613 | 26D/626 | 10BE/BSP | 15/619 | 26/625 | 32D/630 |
| 445 | 42.20 | 41.20 | 41.20 | 41.20 | 27.10 | 49.70 | 44.20 | 42.50 | |
| 445H | 63.00 | 63.00 | 63.00 | 70.00 | 41.90 | 79.00 | 70.00 | 63.00 | |

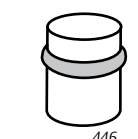

| Door Stop | | | | | | | | | |
|-----------|-------|-------|-------|-------|-------|-------|-------|-------|-------|
| Part | 4/606 | 51.00 | 51.00 | 36.10 | 62.00 | 52.00 | 49.20 | 58.00 | |
| 446 | 48.70 | 48.70 | 51.00 | 51.00 | 36.10 | 62.00 | 52.00 | 49.20 | 58.00 |

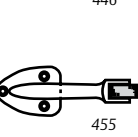

| Curved Roller Stop - Rubber Bumper | | | | | | | |
|------------------------------------|-------|-----------------|---------|----------|------------------|---------|--|
| Part | 3/605 | 4/606 10/612 | 10B/613 | 10BE/BSP | 15/619 26/625 | 26D/626 | |
| 455 | 55.00 | 61.00 | 64.00 | 70.00 | 67.00 | 52.00 | |

| Straight Roller Stop - Rubber Bumper | | | | | | | | | |
|--------------------------------------|------------------------------------|-------|--------|---------|----------|--------|---------|--------|--|
| Part | 3/605 | 4/606 | 10/612 | 10B/613 | 10BE/BSP | 15/619 | 26D/626 | 26/625 | |
| 456-RKW | 57.00 | 61.00 | 58.00 | 61.00 | 75.00 | 67.00 | 47.30 | 57.00 | |
| 456B | Gray or Black (replacement bumper) | | | | | | | 9.60 | |
| 456L | 63.00 | 65.00 | 65.00 | 67.00 | 78.00 | 83.00 | 59.00 | 77.00 | |

| Kick Down Door Stop - Rubber Bumper | |
|-------------------------------------|---------------|
| Part | BRS, BRZ, CRM |
| 458 | 15.80 |

| Spring Loaded Plunger Stop - Rubber Bumper | | | | | | | | |
|--|-------|-------|--------|---------|----------|--------|---------|--------|
| Part | 3/605 | 4/606 | 10/612 | 10B/613 | 10BE/BSP | 15/619 | 26D/626 | 26/625 |
| 459 | 67.00 | 67.00 | 67.00 | 72.00 | 84.00 | 73.00 | 53.00 | 71.00 |

| Kick Down Door Stop - Rubber Bumper | | | | | | | | | |
|-------------------------------------|------------------------------------|-------|-------|-------|-------|-------|-------|-------|--|
| Part | ALM, BRS, BRZ, ORB | | | | | | | 25.50 | |
| 460 | ALM, BRS, BRZ, ORB | | | | | | | 25.50 | |
| 461 | 50.00 | 56.00 | 56.00 | 51.00 | 72.00 | 67.00 | 46.20 | 73.00 | |
| 461B | Gray or Black (replacement bumper) | | | | | | | 6.40 | |

| Heavy Duty Door Stops | | | | | | | | |
|-----------------------|-------|-------|--------|---------|----------|--------|---------|--------|
| Part | 3/605 | 4/606 | 10/612 | 10B/613 | 10BE/BSP | 15/619 | 26D/626 | 26/625 |
| 461L | 73.00 | 70.00 | 70.00 | 71.00 | 82.00 | 76.00 | 55.00 | 78.00 |

| Heavy Duty Door Stops | | | | |
|-----------------------|--------|---------|---------|--------|
| Part | 2C/603 | 26D/626 | 32D/630 | Black |
| 462 | 68.00 | | | |
| 463-RKW | | | 68.00 | |
| 464-RKW | | 141.00 | | |
| 465 | | 91.00 | | |
| 466-RKW | | | | 42.40 |
| 467-RKW | | | | 62.00 |
| 468-RKW | | | | 158.00 |

| Door Stops - Rubber Bumper | | | | | | | | | |
|----------------------------|--------------------|-------|--------|---------|----------|--------|---------|--------|--|
| Part | 3/605 | 4/606 | 10/612 | 10B/613 | 10BE/BSP | 15/619 | 26D/626 | 26/625 | |
| 470 | 43.80 | 53.00 | 53.00 | 57.00 | 63.00 | 63.00 | 42.50 | 62.00 | |
| 471 | 43.80 | 53.00 | 53.00 | 57.00 | 63.00 | 63.00 | 42.50 | 62.00 | |
| 472 | 90.00 | 90.00 | 90.00 | 97.00 | 108.00 | 103.00 | 58.00 | 107.00 | |
| 473 | 90.00 | 90.00 | 90.00 | 97.00 | 108.00 | 103.00 | 58.00 | 107.00 | |
| 474 | 55.00 | 56.00 | 56.00 | 57.00 | 63.00 | 63.00 | 41.40 | 62.00 | |
| 475 | 52.00 | 53.00 | 53.00 | 57.00 | 63.00 | 60.00 | 41.70 | 59.00 | |
| 476 | 79.00 | 79.00 | 79.00 | 85.00 | 94.00 | 90.00 | 56.00 | 99.00 | |
| 477 | 79.00 | 79.00 | 79.00 | 85.00 | 94.00 | 90.00 | 56.00 | 99.00 | |
| 480 | 49.20 | 47.30 | 47.30 | 49.80 | 55.00 | 63.00 | 41.90 | 61.00 | |
| 480H | 58.00 | 55.00 | 55.00 | 57.00 | 63.00 | 69.00 | 47.10 | 69.00 | |
| 481 | 56.00 | 56.00 | 56.00 | 59.00 | 66.00 | 65.00 | 43.50 | 62.00 | |
| 481H | 59.00 | 57.00 | 57.00 | 60.00 | 66.00 | 70.00 | 48.70 | 70.00 | |
| 481MP | Powder Coat Finish | | | | | | | 123.00 | |
| 482 | 41.90 | 48.70 | 48.70 | 44.40 | 54.00 | 55.00 | 39.30 | 55.00 | |
| 483 | 46.10 | 49.80 | 49.80 | 47.30 | 54.00 | 61.00 | 42.50 | 58.00 | |
| 485 | 74.00 | 67.00 | 67.00 | 71.00 | 79.00 | 76.00 | 57.00 | 76.00 | |

| Angle Door Stop - Rubber Bumper | |
|---------------------------------|--------|
| Part | 2C/603 |
| 486 | 17.90 |

| Heavy Duty Wall Stop - Rubber Bumper | |
|--------------------------------------|---------|
| Part | 26D/626 |
| 487 | 71.00 |

Door Stops (con't)

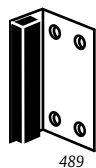

489

| Door Stops | | | | | | |
|------------|--------|--------|--------|---------|----------|--------|
| Part | 3/605 | 4/606 | 10/612 | 10B/613 | 10BE/BSP | 15/619 |
| 488 | 100.00 | 100.00 | 110.00 | 110.00 | 140.00 | 107.00 |
| 489 | 122.00 | 122.00 | 136.00 | 136.00 | 167.00 | 136.00 |

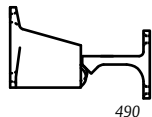

490

| Door Holder & Stop | |
|--------------------|---------|
| Part | 26D/626 |
| 490 | 69.00 |

| Automatic Door Holder & Stop | | | | | | | | |
|------------------------------|--------|--------|--------|---------|----------|--------|---------|--------|
| Part | 3/605 | 4/606 | 10/612 | 10B/613 | 10BE/BSP | 15/619 | 26D/626 | 26/625 |
| 491-RKW | 101.00 | 107.00 | 107.00 | 113.00 | 124.00 | 134.00 | 99.00 | 138.00 |
| 491R | 104.00 | 110.00 | 110.00 | 115.00 | 127.00 | 264.00 | 101.00 | 140.00 |
| 491S | 106.00 | 112.00 | 112.00 | 117.00 | 130.00 | | 103.00 | 143.00 |
| 494-RKW | 124.00 | 129.00 | 124.00 | 129.00 | 143.00 | 151.00 | 115.00 | 155.00 |
| 494R | 127.00 | 131.00 | 127.00 | 131.00 | 145.00 | | 118.00 | 158.00 |
| 494S | 129.00 | 134.00 | 129.00 | 134.00 | 148.00 | | 120.00 | 160.00 |

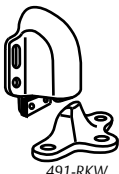

491-RKW

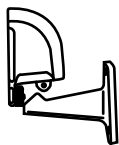

494-RKW

| Door Stops - Rubber Bumper | | | | | | | | |
|----------------------------|-------|-------|--------|---------|----------|--------|---------|--------|
| Part | 3/605 | 4/606 | 10/612 | 10B/613 | 10BE/BSP | 15/619 | 26D/626 | 26/625 |
| 505-RKW | 21.70 | 28.50 | 28.50 | 28.50 | 31.50 | 30.60 | 21.10 | 26.00 |
| 508 | 34.60 | 34.60 | 34.60 | 38.20 | 42.20 | 39.00 | 32.00 | 34.60 |

| Part | Polished Brass (BRS) | | | | Burnished Aluminum (ALM) | | | |
|--------------------------------|----------------------|-------|--------|---------|--------------------------|---------|--------|-------|
| | 3/605 | 4/606 | 10/612 | 10B/613 | 15/619 | 26D/626 | 26/625 | |
| 517 | 8.70 | | | | 8.10 | | | |
| 518 | 27.60 | 28.50 | 28.50 | 31.40 | 34.70 | 31.40 | 23.60 | 27.90 |
| 519 | 23.30 | 27.60 | 27.60 | 29.70 | 32.90 | 31.10 | 22.00 | 27.60 |
| 520 White (replacement bumper) | | | | | | | 6.80 | |

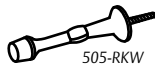

505-RKW



519



525

| Part | Antique Brass (ANT) | | | Polished Brass (BRS) | | Bright Nickel (NP) | |
|------|---------------------|-------|--------|----------------------|--------|--------------------|--------|
| | 3/605 | 4/606 | 10/612 | 10B/613 | 15/619 | 26D/626 | 26/625 |
| 525 | 2.50 | | | 2.50 | | 2.90 | |
| 526 | | | | 2.80 | | 3.20 | |
| 528 | 7.90 | | | 7.90 | | 9.10 | |

Flush Bolts, Guides & Strikes

| Flush Bolts, Guides & Strikes | | | | | | | | |
|---|--------|-------|--------|---------|----------|--------|---------|--------|
| Part | 3/605 | 4/606 | 10/612 | 10B/613 | 10BE/BSP | 15/619 | 26D/626 | 26/625 |
| 550 | 46.90 | 57.00 | 57.00 | 61.00 | 72.00 | 65.00 | 47.30 | 73.00 |
| 550G | 13.10 | | | 13.10 | 14.60 | | 10.90 | |
| 550S | 13.10 | | | 13.10 | 14.60 | | 10.90 | |
| 554 | 107.00 | | | 107.00 | 125.00 | | 102.00 | |
| 554G | 71.00 | | | 71.00 | 84.00 | | 69.00 | |
| 554S | 71.00 | | | 71.00 | 84.00 | | 69.00 | |
| 555 | 34.90 | 34.90 | 38.00 | 36.30 | 49.00 | 44.40 | 28.10 | 38.40 |
| 555B(1 1/2" standard bolt head) | | | | 13.10 | | | | |
| 555B(extra long bolt head - specify length) | | | | 41.40 | | | | |
| 555G | 11.00 | | | 11.00 | 12.10 | | 8.80 | |
| 555S | 11.00 | | | 11.00 | 12.10 | | 8.80 | |
| 555ROD/per ft. (specify length) | | | | | | | | 5.70 |
| 555 x 18BFB | | | | | | | 283.00 | |
| 556WS | | | | | | | 80.00 | |
| 557 | 53.00 | 53.00 | 53.00 | 53.00 | 78.00 | 71.00 | 53.00 | 55.00 |
| 557S | 13.10 | | | 13.10 | 14.10 | | 10.90 | |
| 557 x 19BFB | | | | | | | 313.00 | |
| 570 | 39.90 | 37.10 | 41.60 | 41.60 | 56.00 | 49.00 | 31.60 | 40.20 |

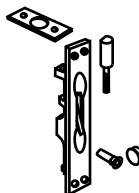

555 x 18BFB

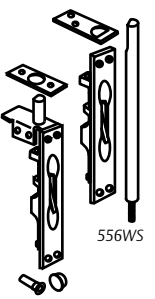

556WS

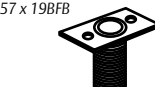

557 x 19BFB

ASSA ABLOY

Opening Solutions

The global leader in door opening solutions

Gravity Door Coordinator

| Gravity Door Coordinators | | | | | |
|---------------------------|----------------|-------------------|----------|------------------|---------|
| Part | 3/605 4/606 | 10/612 10B/613 | 10BE/BSP | 15/619 26/625 | 26D/626 |
| 576 | 127.00 | 127.00 | 160.00 | 141.00 | 108.00 |
| 576B Gray | | | | 4.90 | |

Surface Bolts

| Surface Bolts | | | | | |
|---------------|-------|---------|----------|---------|---------|
| Part | 3/605 | 10B/613 | 10BE/BSP | 26D/626 | 32D/630 |
| 580-8 | 59.00 | 62.00 | 112.00 | 49.70 | 103.00 |
| 580-12 | | | 130.00 | 58.00 | |
| 580-18 | | | 324.00 | 268.00 | |
| 580-24 | | | 348.00 | 287.00 | |
| 582-8 | | | | | 213.00 |
| 582-12 | | | | | 260.00 |

Heavy Duty Surface Bolts

| | | | | | |
|--------|--|--|--|--------|--|
| 585-12 | | | | 224.00 | |
| 585-24 | | | | 276.00 | |

Roller Latches

| Roller Latches | | | | | | | | |
|---------------------|--------|--------|--------|---------|----------|--------|---------|--------|
| Part | 3/605 | 4/606 | 10/612 | 10B/613 | 10BE/BSP | 15/619 | 26D/626 | 26/625 |
| 590 | 60.00 | 84.00 | 84.00 | 65.00 | 93.00 | 71.00 | 49.40 | 62.00 |
| 590DA (Strike Only) | | | 194.00 | 194.00 | 194.00 | | | |
| 590SO | 35.50 | | | 35.50 | 41.60 | | 33.10 | |
| 591 | 65.00 | 89.00 | 89.00 | 77.00 | 98.00 | 99.00 | 54.00 | 84.00 |
| 591SO | 42.60 | | | 42.60 | 46.90 | | 37.80 | |
| 592 | 60.00 | 84.00 | 84.00 | 63.00 | 93.00 | 84.00 | 49.40 | 62.00 |
| 592SO | 35.50 | | | 35.50 | 41.60 | | 33.10 | |
| Part | 3/605 | 4/606 | 10/612 | 10B/613 | 10BE/BSP | 15/619 | 26D/626 | 26/625 |
| 593 | 125.00 | 125.00 | 137.00 | 141.00 | 92.00 | 135.00 | | |
| Part | 3/605 | 4/606 | 10/612 | 10B/613 | 10BE/BSP | 15/619 | 26D/626 | 26/625 |
| 593SO | 35.50 | | | 35.50 | 41.60 | | 33.10 | |
| 594 | 77.00 | 77.00 | 77.00 | 85.00 | 93.00 | 85.00 | 52.00 | 77.00 |
| 594SO | | | | 41.60 | | | | |

Gate Latch

| Gate Latch | | | | |
|--------------------|-------|-------------------|----------|---------|
| Part | 4/606 | 10/612 10B/613 | 10BE/BSP | 26D/626 |
| 602 | 91.00 | 91.00 | 106.00 | 86.00 |
| 602 Spring (25 pk) | | | | 26.10 |

Door Guards

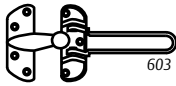

| Door Guards | | | | | |
|-------------|---------------------|-------|-----------------------------|---------------------|--------|
| Part | Antique Brass (ANT) | | Polished Brass (BRS) | Bright Chrome (CRM) | |
| 603 | 23.10 | | 23.10 | 23.10 | |
| 603 Shim | Clear Plastic | | 5.70 | | |
| Part | 3/605 | 4/606 | 10/612 10B/613 15/619 | 26D/626 | 26/625 |
| 604 | 51.00 | 48.30 | 53.00 | 41.40 | 48.90 |
| 604 Shim | Clear Plastic | | 5.80 | | |

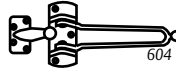

Door Guard Protection Plate

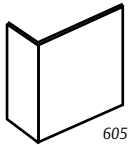

| Door Guard Protection Plate | | | | |
|-----------------------------|----------------|-----------------------------|---------|--------|
| Part | 3/605 4/606 | 10/612 10B/613 15/619 | 26D/626 | 26/625 |
| 605 | 11.80 | 11.80 | 12.70 | 13.20 |
| 605SMS | 24.20 | 26.60 | 24.20 | |

Wall Guard

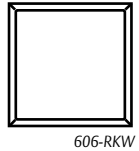

| Wall Guard | | |
|------------|-----------|-------|
| Part | Pack Size | Clear |
| 606-RKW | 55/sheet | 99.00 |

Privacy Door Latch

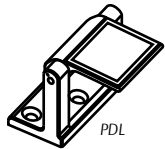

| Privacy Door Latch | | | |
|--------------------|-------|---------|---------|
| Part | 3/605 | 10B/613 | 26D/626 |
| PDL | 74.00 | 111.00 | 71.00 |

Door Silencers

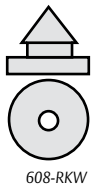

| Door Silencers | | | |
|----------------|-----------|--------|-------------|
| Part | Pack Size | Clear | Gray Rubber |
| 608-RKW | 100 | | 18.20 |
| 608CA | 300 | 191.00 | |
| 609 | 100 | | 27.30 |

Door Knockers

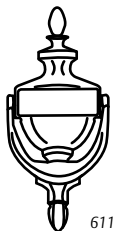

| Door Knockers | | | | | | | |
|---------------|-------|--------|--------|---------|----------|--------|---------|
| Part | 3/605 | 4/606 | 10/612 | 10B/613 | 10BE/BSP | 15/619 | 26D/626 |
| 611 | 78.00 | 100.00 | 100.00 | 106.00 | 114.00 | 111.00 | 76.00 |
| 614 | 64.00 | | | 84.00 | 94.00 | 107.00 | 62.00 |
| 614V | 64.00 | 84.00 | 106.00 | 84.00 | 88.00 | 84.00 | 62.00 |

For 611, drill for Viewer. Add \$10.00.

Door Viewers

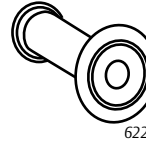

| Door Viewers | | | | | |
|--------------|----------------------|----------------------|---------------------|---------------------|--------------------|
| Part | Antique Bronze (ANT) | Polished Brass (BRS) | Bright Chrome (CRM) | Satin Nickel (STNN) | Dull Chrome (DCRM) |
| 619 | 21.70 | 19.80 | 19.80 | 21.60 | |
| 620 | 12.30 | 12.30 | 12.30 | 14.70 | |
| 621 | 14.50 | 14.50 | 14.50 | | |
| 622 | 18.50 | 18.50 | 18.50 | 21.60 | 18.70 |

Door Viewer Washers

| Door Viewer Washers | | |
|---------------------|----------------------|----------------------|
| Part | Stainless Steel (SS) | Polished Brass (BRS) |
| 619W 1/2" Hole | 21.70 | 19.80 |
| 626W 9/16" Hole | 15.80 | 15.80 |

Door Viewers with Covers

| Door Viewers with Covers | | | | | | |
|--------------------------|-----------|----------------------|----------------------|---------------------|--------------------|-------------|
| Part | Pack Size | Antique Bronze (ANT) | Polished Brass (BRS) | Bright Chrome (CRM) | Dull Chrome (DCRM) | Black (BLK) |
| 620VC Covers Only | 10 | 89.00 | 89.00 | 89.00 | | |
| 622VC Covers Only | 10 | 109.00 | 109.00 | 109.00 | | |
| 624 | | 19.50 | 19.50 | 19.50 | | |
| 626 | | 25.30 | 25.30 | 25.30 | 25.30 | |
| 627 | | | | 35.70 | | 45.80 |
| 628 | | | | 34.90 | | 44.40 |
| 629 | | | | 37.60 | | 48.20 |

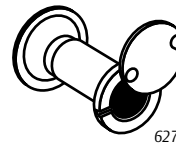

Surface Bolts

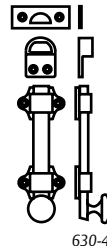

| Surface Bolts | | | | |
|---------------|--------|---------|----------|---------|
| Part | 3/605 | 10B/613 | 10BE/BSP | 26D/626 |
| 630-4 | 51.00 | 61.00 | 108.00 | 49.10 |
| 630-8 | 95.00 | 114.00 | 169.00 | 92.00 |
| 630-12 | 171.00 | 221.00 | 286.00 | 214.00 |
| 630-24 | 290.00 | 373.00 | 539.00 | 361.00 |

Card Holder

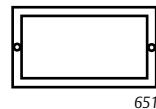

| Card Holder | | | | |
|-------------|----------------|-------------------|----------|---------|
| Part | 3/605 4/606 | 10/612 10B/613 | 10BE/BSP | 26D/626 |
| 651 | 41.20 | 41.20 | 45.00 | 38.80 |

Decals

| Decals | |
|---------|-------|
| Part | Price |
| 660 | 12.60 |
| 661 | 12.60 |
| 662-RKW | 12.90 |

THIS DOOR TO REMAIN UNLOCKED DURING BUSINESS HOURS
660

THIS DOOR TO REMAIN UNLOCKED WHILE BUILDING IS OCCUPIED
661

THESE DOORS TO REMAIN UNLOCKED WHILE BUILDING IS OCCUPIED
662-RKW

670 Series Engraved Signs

•SPECIFY COPY•

670

•WOMEN•

670W

P
U
S
H

674H

| 670 Series Engraved | | | | | | | | |
|------------------------------|------------------------|--------|----------------|--------|---------|----------|-------------------|---------|
| Part | Black or Brown Plastic | 28/628 | 3/605 4/606 | 10/612 | 10B/613 | 10BE/BSP | 26/625 26D/626 | 32D/630 |
| 670 (1"H Letters or smaller) | 15.80 | 30.60 | 30.70 | 32.20 | 33.30 | 37.10 | 32.20 | 31.60 |
| 670 (Over 1" up to 3") | 28.80 | 44.10 | 45.90 | 45.90 | 45.90 | 55.00 | 43.70 | 46.50 |
| 670M | 37.70 | 71.00 | 64.00 | 72.00 | 72.00 | 104.00 | | 78.00 |
| 670W | 54.00 | 97.00 | 101.00 | 113.00 | 113.00 | 144.00 | | 112.00 |
| 670R | 37.70 | 141.00 | 146.00 | 146.00 | 146.00 | 195.00 | | 163.00 |
| 674H (PUSH) | 44.30 | 59.00 | 90.00 | 80.00 | 80.00 | 101.00 | 80.00 | 85.00 |
| 674L (PULL) | 44.30 | 59.00 | 90.00 | 80.00 | 80.00 | 101.00 | 80.00 | 85.00 |

Available in .125" thick plastic or .050" thick metal. Pricing is per letter for Part 670—minimum of 3 letters; per sign for Part's 670M, 670W, 670R. Call for pricing on multi-line signs.

BF680 Series Barrier Free Signs

•SPECIFY COPY•

BF680

| BF680 Series Barrier Free | | | | | | | | | |
|---------------------------|-----------------------------------|--------|----------------|--------|---------|----------|----------|-------------------|---------|
| Part | Black, Blue, Brown or Red Plastic | 28/628 | 3/605 4/606 | 10/612 | 10B/613 | 10BL/614 | 10BE/BSP | 26/625 26D/626 | 32D/630 |
| BF680 | 31.00 | 61.40 | 58.70 | 56.70 | 63.90 | 54.60 | 78.80 | 56.70 | 67.70 |
| BF680M | 68.00 | 156.00 | 146.00 | 146.00 | 146.00 | 173.00 | 202.00 | 140.00 | 165.00 |
| BF680W | 98.00 | 227.00 | 214.00 | 214.00 | 214.00 | 240.00 | 310.00 | 205.00 | 258.00 |
| BF680R | 138.00 | 331.00 | 310.00 | 310.00 | 310.00 | 339.00 | 478.00 | 302.00 | 401.00 |

Standard 1" letter height. Grade 2 Braille translations. Available in .125" non-glare plastic or .050" thick metal. Pricing is per letter for Part BF680—minimum of 3 letters per sign for Part's BF680M, BF680W, BF680R. Screw mounting provided. Self-adhesive mounting available.

BF Series ADA Tactile Signs



BF685



BF687



BF688

| BF Series ADA Tactile | | | | | | |
|-----------------------|-----------------------------------|----------------|--------------------|----------|-------------------|---------|
| Part | Black, Blue, Brown or Red Plastic | 3/605 4/606 | 10/612 10BL/614 | 10BE/BSP | 26/625 26D/626 | 32D/630 |
| BF683 | 118.00 | 361.00 | 361.00 | 386.00 | 332.00 | 325.00 |
| BF684 | 118.00 | 358.00 | 358.00 | 386.00 | 332.00 | 325.00 |
| BF685 | 118.00 | 358.00 | 358.00 | 386.00 | 332.00 | 325.00 |
| BF686 | 118.00 | 415.00 | 415.00 | 452.00 | 385.00 | 378.00 |
| BF687 | 118.00 | 386.00 | 386.00 | 419.00 | 357.00 | 350.00 |
| BF688 | 118.00 | 386.00 | 386.00 | 419.00 | 357.00 | 350.00 |
| BF689 | 118.00 | 415.00 | 415.00 | 452.00 | 385.00 | 378.00 |

Standard 1" letter height. Grade 2 Braille translations. Available in .125" non-glare plastic or .050" thick metal. Screw mounting provided. Self-adhesive mounting available.

BFM Series ADA Molded Plastic Signs



BFM687



BFM688



BFM689

| Molded Plastic | | |
|----------------|-------|-------|
| Part | Black | Blue |
| BFM682 | 31.30 | 31.30 |
| BFM684 | 31.30 | 31.30 |
| BFM685 | 31.30 | 31.30 |
| BFM686 | 31.30 | 31.30 |
| BFM687 | 31.30 | 31.30 |
| BFM688 | 31.30 | 31.30 |
| BFM689 | 31.30 | 31.30 |

Standard 5/8" letter height. Grade 2 Braille translations. Self-adhesive mounting.



BFM624



BFM625

All Gender Restroom Signs

| Molded Plastic | |
|----------------|-------|
| Part | Blue |
| BFM624 | 42.90 |
| BFM625* | 34.10 |

*Standard 5/8" letter height. Grade 2 Braille translations. Self-adhesive mounting.

ASSA ABLOY

Opening Solutions

The global leader in door opening solutions

Auxiliary Hardware

Hand Rail Brackets - Specify Wood or Metal Rail

| Part | 3/605 | 10B/613 | 10BE/BSP | 15/619 | 26D/626 | 26/625 |
|------|--------|---------|----------|--------|---------|--------|
| 700 | 116.00 | 129.00 | | 142.00 | 125.00 | 124.00 |
| 701 | 118.00 | 126.00 | 143.00 | 133.00 | 117.00 | 118.00 |
| 702 | 105.00 | 113.00 | 133.00 | 124.00 | 109.00 | 108.00 |

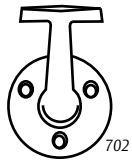

Coat Hooks

| Part | 3/605 | 10B/613 | 10BE/BSP | 15/619 | 15A/620 | 26D/626 | 26/625 |
|------|-------|---------|----------|--------|---------|---------|--------|
| 790 | 17.80 | 23.60 | 39.00 | | 44.40 | 16.30 | 19.40 |
| 796 | 18.70 | 25.50 | 41.60 | 25.80 | 41.20 | 19.80 | 16.30 |
| 802 | 21.30 | 27.70 | 47.80 | 26.50 | 43.40 | 22.50 | 18.20 |
| 806 | 23.60 | 30.50 | 51.00 | 30.50 | 45.70 | 26.00 | 21.10 |

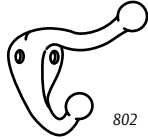

Ball Knob

| Part | 3/605 | 10B/613 | 10BE/BSP | 15/619 | 26D/626 | 26/625 |
|------|-------|---------|----------|--------|---------|--------|
| 841 | 17.10 | 25.50 | 33.00 | 26.00 | 16.60 | 17.10 |



Utility Pull

| Part | 3/605 4/606 | 10B/613 | 10BE/BSP | 26/625 26D/626 | Burnished Aluminum |
|------|----------------|---------|----------|-------------------|--------------------|
| 845 | 68.00 | 68.00 | 74.00 | 66.00 | 23.80 |

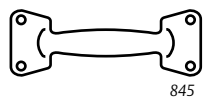

Wire Pulls - Specify Door Thickness

| Part | 3/605 4/606 | 10B/613 | 10BE/BSP | 26D/626 | 26/625 | 32D/630 | 32DMS |
|---------|----------------|---------|----------|---------|--------|---------|-------|
| 850 | 59.00 | 63.00 | 61.00 | 57.00 | | | |
| 851 | 59.00 | 63.00 | 61.00 | 57.00 | | | |
| 852 | 59.00 | 63.00 | 61.00 | 57.00 | | | |
| 853 | 13.10 | 22.50 | 42.00 | 13.90 | 13.10 | 13.50 | 56.00 |
| 856-RKW | 66.00 | 68.00 | 69.00 | 63.00 | | | |



Flush Pulls

| Part | 3/605 | 10BE/BSP | 26D/626 | 32D/630 |
|------|-------|----------|---------|---------|
| 860 | | 22.70 | | 12.40 |
| 870 | 10.90 | 15.10 | | 7.70 |
| 872 | 27.50 | 50.00 | 31.10 | |

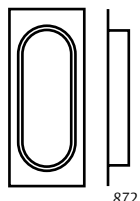

Edge Pulls

| Part | 3/605 | 10B/613 | 10BE/BSP | 26D/626 | 26/625 |
|---------|-------|---------|----------|---------|--------|
| 880 | 24.90 | 27.30 | | 24.20 | |
| 885-RKW | 82.00 | 93.00 | 127.00 | 90.00 | 93.00 |

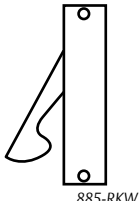

Pocket Door Pulls - For use on 1 3/8" to 1 3/4" Doors

| Part | 3/605 | 10B/613 | 26D/626 | 26/625 |
|------|-------|---------|---------|--------|
| 890 | 25.50 | 27.30 | 24.60 | 25.50 |
| 891 | 26.50 | 28.90 | 25.70 | 26.50 |

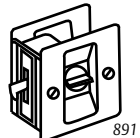

Magnetic Catches

| Part | Brass | Aluminum |
|------|-------|----------|
| 900 | 16.50 | 17.10 |
| 901 | 23.70 | 24.50 |

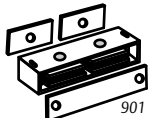

Adjustable Ball Catches

| Part | 3/605 | 26D/626 |
|-------|-------|---------|
| 910 | 17.40 | 17.20 |
| 910RC | 25.60 | 23.00 |
| 911 | 18.40 | 18.30 |
| 911RC | 28.10 | 25.60 |

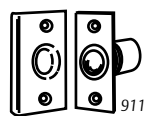

Coordinators

Carry Bar for 2600 Series Coordinators

| Part | Black Prime Coated | 3/605 4/606 | 10/612 26D/626 | 10B/613 |
|------|--------------------|----------------|-------------------|---------|
| 1100 | 93.00 | 139.00 | 90.00 | 139.00 |

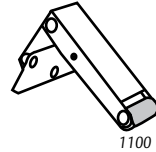

Mounting Brackets (For Soffit Applied Hardware)

| Part | Black Prime Coated | 28/628 |
|--------|--------------------|--------|
| 2601AB | 34.00 | 50.00 |
| 2601C | 34.00 | 50.00 |

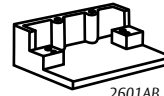

2600 Series Coordinators w/Filler and Filler Bars

| | | |
|---------------|--------|--------|
| NX2648-NX2654 | 224.00 | 252.00 |
| 2655-2660 | 232.00 | 229.00 |
| 2661-2672 | 179.00 | 229.00 |
| 2673-2696 | 206.00 | 252.00 |
| L2662-L26112 | 179.00 | 229.00 |
| FB-1 | 68.00 | 56.00 |
| FB-2 | 65.00 | 65.00 |

1700 Universal Door Coordinator

| | | |
|------|--------|--------|
| 1700 | 190.00 | 205.00 |
|------|--------|--------|

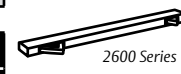

Flush Bolts

Flush Bolts

| Part | 3/605 4/606 10/612 10B/613 26/625 | 10BE/BSP | 26D/626 | 32D/630 |
|--------------------------|---|----------|---------|---------|
| 2805 | 144.00 | 190.00 | 139.00 | 139.00 |
| 2840 | 144.00 | 190.00 | 139.00 | 139.00 |
| 2842 | 272.00 | 360.00 | 244.00 | 243.00 |
| 2845 | 272.00 | 360.00 | 263.00 | 263.00 |
| 2848 | 272.00 | 360.00 | 263.00 | 263.00 |
| 2849 | 272.00 | 360.00 | 263.00 | 263.00 |
| 2905 | 150.00 | 185.00 | 146.00 | 145.00 |
| 2940 | 150.00 | 185.00 | 146.00 | 145.00 |
| 2942 | 293.00 | 388.00 | 263.00 | 263.00 |
| 2945 | 293.00 | 388.00 | 284.00 | 284.00 |
| 2948 | 293.00 | 359.00 | 284.00 | 284.00 |
| 2949 | 293.00 | 349.00 | 284.00 | 284.00 |
| 2960 | 343.00 | 421.00 | 333.00 | 332.00 |
| 2962 | 343.00 | 421.00 | 333.00 | 332.00 |
| BFB (wood or metal door) | | | | 230.00 |
| CPK2840 | 41.20 | 46.90 | 39.10 | 39.50 |

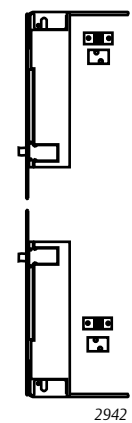
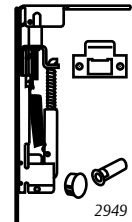

AUXILIARY HARDWARE / COORDINATORS / FLUSH BOLTS

Overhead Holders & Stops

| Heavy Duty Concealed | | |
|-------------------------------|---------|---------|
| Part | 10B/613 | 32D/630 |
| OH101S | 633.00 | 584.00 |
| OH102S | 633.00 | 584.00 |
| OH103S | 633.00 | 584.00 |
| OH104S | 633.00 | 584.00 |
| OH105S | 633.00 | 584.00 |
| OH101H | 633.00 | 531.00 |
| OH102H | 633.00 | 531.00 |
| OH103H | 633.00 | 531.00 |
| OH104H | 633.00 | 531.00 |
| OH105H | 633.00 | 531.00 |
| Standard Duty Concealed | | |
| OH201M | 308.00 | 237.00 |
| OH202M | 308.00 | 237.00 |
| OH203M | 308.00 | 237.00 |
| OH204M | 308.00 | 237.00 |
| OH205M | 308.00 | 237.00 |
| Heavy Duty Surface Mounted | | |
| OH901S | 598.00 | 521.00 |
| OH902S | 598.00 | 521.00 |
| OH903S | 598.00 | 521.00 |
| OH904S | 598.00 | 521.00 |
| OH905S | 598.00 | 521.00 |
| OH901H | 598.00 | 521.00 |
| OH902H | 598.00 | 521.00 |
| OH903H | 598.00 | 521.00 |
| OH904H | 598.00 | 521.00 |
| OH905H | 598.00 | 521.00 |
| Standard Duty Surface Mounted | | |
| OH1001M | 382.00 | 258.00 |
| OH1002M | 382.00 | 258.00 |
| OH1003M | 382.00 | 258.00 |
| OH1004M | 382.00 | 258.00 |
| OH1005M | 382.00 | 258.00 |

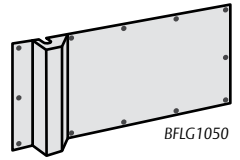
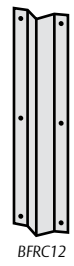
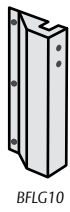
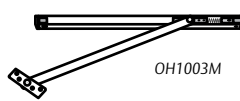
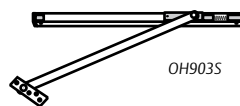
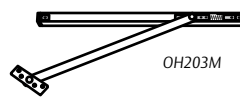
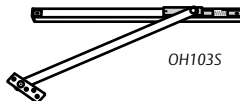

Covers

| Latch Guard Covers - .050" Thick (Specify Handing) | | | | |
|--|---------------|----------|----------|---------|
| Part | 3/605 | 10B/613 | 10BE/BSP | 32D/630 |
| BFLG10 | | | 283.00 | 232.00 |
| BFLG12 | | | 296.00 | 241.00 |
| BFLG16 | | | 327.00 | 270.00 |
| Vertical Rod Covers - .050" Thick | | | | |
| BFRC12 | 130.00 | 139.00 | 104.00 | 88.00 |
| BFRC24 | 208.00 | 221.00 | 148.00 | 123.00 |
| Vertical Rod Latch Guard Cover | | | | |
| Part | Width of Door | 10BE/BSP | 32D/630 | |
| BFLG1050 | Up to 36" | 481.00 | 369.00 | |

Over 36" add \$1.90/in.

ASSA ABLOY

Opening Solutions

The global leader in door opening solutions

Pivots

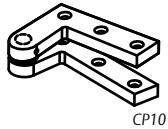

CP10

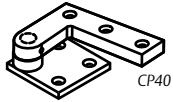

CP40

| Standard Head | | | | |
|----------------|----------------|-------------------|----------|-------------------|
| Part | 3/605 4/606 | 10/612 10B/613 | 10BE/BSP | 26/625 26D/626 |
| CP10 | 537.00 | 588.00 | 674.00 | 568.00 |
| CP10HD | 779.00 | 831.00 | 956.00 | 806.00 |
| Standard Floor | | | | |
| CP40 | 537.00 | 588.00 | 674.00 | 568.00 |
| CP40HD | 779.00 | 831.00 | 956.00 | 806.00 |

Prices are for 1 3/4" thick wood doors. Pivots for thicker doors are priced on application. Allow 4 weeks delivery. NOTE: Pivots are 3/8" x 7/8" wide; HD (heavy duty) pivots are 1/2" x 1" wide.

Custom Strikes

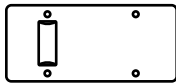

590DA

| Custom Strikes | | | | | |
|---|----------|-------------------------------------|--------------|-----------------------------|---------|
| Part | Quantity | 3/605 4/606 10/612 10B/613 | 10BE/ BSP | 26/625 26D/626 32/629 | 32D/630 |
| CS-ASA1, CS-ASA2, CS-OM, CS-T, 590-DA | Up to 5 | 108.00 | 113.00 | 108.00 | 80.00 |
| | 6 to 10 | 96.00 | 101.00 | 96.00 | 74.00 |
| | 11 to 20 | 90.00 | 95.00 | 90.00 | 64.00 |
| | 21 + | 84.00 | 88.00 | 84.00 | 59.00 |

.090" Thick (\$203 minimum charge. Made to your specifications.)

Filler Plates & Shims



DF86

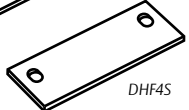

DHF4S

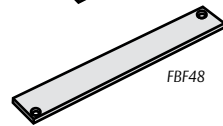

FBFB48

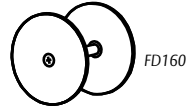

FD160

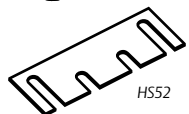

HS52

| Filler Plates & Shims | | |
|-----------------------|-----------|--------|
| Part | Pack Size | Price |
| DF86 | 25 | 180.00 |
| DFF4 | 25 | 135.00 |
| DFF5 | 25 | 150.00 |
| DHF4B | 25 | 140.00 |
| DHF4S | 25 | 145.00 |
| DHF5B | 25 | 135.00 |
| DHF5S | 25 | 150.00 |
| FBFB48 | 25 | 160.00 |
| FBS48 | 25 | 95.00 |
| FC161 | 25 | 172.50 |
| FD160 | 25 | 150.00 |
| HS42 | 50 | 120.00 |
| HS44 | 50 | 145.00 |
| HS52 | 50 | 145.00 |

Sold in pack quantities only.

Angle Plates

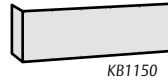

KB1150



KB1151



KB1152

| Angle Plates | | |
|-------------------|-------------|--|
| Part | Description | Pricing |
| KB1150 Style A | One-Sided | Fax or Email Dimensions for Pricing |
| KB1151 Style C | Two-Sided | Fax or Email Dimensions for Pricing |
| KB1152 Style B | Bottom | Fax or Email Dimensions for Pricing |

.050" Thick - Refer to page 41 for Angle Plate Fasteners. Add \$75 list per bend to plates price.

Trim Protector Bars

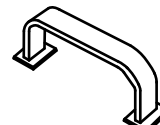

HD2250



R111LPB



R116EDPH



SD1260

| Heavy Duty - 3/8" thick stainless for heavy traffic. | | | | | |
|---|--------|-------------------|--------------|-------------|--------|
| Part | CTC | 10BE/ BSP | 32D/ 630 | 32DMS | |
| HD2230 | 8" | 354.00 | 277.00 | 250.00 | |
| HD2240 | 8" | 354.00 | 277.00 | 250.00 | |
| HD2250 | 8" | 354.00 | 277.00 | 250.00 | |
| Lever - 3/8" thick for heavy traffic. | | | | | |
| Part | 3/605 | 10/612 10B/613 | 10BE/ BSP | 32D/ 630 | 32DMS |
| R101LPB | 440.00 | 505.00 | 246.00 | 185.00 | 206.00 |
| R102LPB | 503.00 | 617.00 | 397.00 | 346.00 | 371.00 |
| R111LPB | 472.00 | 565.00 | 255.00 | 193.00 | 217.00 |
| R112LPB | 528.00 | 645.00 | 456.00 | 401.00 | 424.00 |
| R115LPB | 505.00 | 598.00 | 280.00 | 204.00 | 233.00 |
| Exit Device - 3/8" thick stainless for heavy traffic. Field cutting hinge end of exit device is required. | | | | | |
| R116EDPL | | 627.00 | 516.00 | 424.00 | |
| R116EDPH | | 627.00 | 516.00 | 424.00 | |
| Standard Duty - 3/16" thick stainless for moderate traffic. | | | | | |
| SD1230 | | 130.00 | 99.00 | 101.00 | |
| SD1240 | | 130.00 | 99.00 | 101.00 | |
| SD1250 | | 130.00 | 99.00 | 101.00 | |
| SD1260 | | 130.00 | 99.00 | 101.00 | |

Door Plates Hundred Square Inch Size Chart

To calculate the list price of kick plate, use the hundred square inch number times the list price. (Example: 10" x 34" is 3.40 square inches.) Take that number times the list price from the following page. (Example: 32D list \$19 x 3.40 = \$64.60)

| H/W | 24" | 26" | 28" | 30" | 32" | 34" | 36" | 38" | 40" | 42" | 44" | 46" | 48" |
|-----|-------|-------|-------|-------|-------|-------|-------|-------|-------|-------|-------|-------|-------|
| 4" | 0.96 | 1.04 | 1.12 | 1.20 | 1.28 | 1.36 | 1.44 | 1.52 | 1.60 | 1.68 | 1.76 | 1.84 | 1.92 |
| 6" | 1.44 | 1.56 | 1.68 | 1.80 | 1.92 | 2.04 | 2.16 | 2.28 | 2.40 | 2.52 | 2.64 | 2.76 | 2.88 |
| 8" | 1.92 | 2.08 | 2.24 | 2.40 | 2.56 | 2.72 | 2.88 | 3.04 | 3.20 | 3.36 | 3.52 | 3.68 | 3.84 |
| 10" | 2.40 | 2.60 | 2.80 | 3.00 | 3.20 | 3.40 | 3.60 | 3.80 | 4.00 | 4.20 | 4.40 | 4.60 | 4.80 |
| 12" | 2.88 | 3.12 | 3.36 | 3.60 | 3.84 | 4.08 | 4.32 | 4.56 | 4.80 | 5.04 | 5.28 | 5.52 | 5.76 |
| 14" | 3.36 | 3.64 | 3.92 | 4.20 | 4.48 | 4.76 | 5.04 | 5.32 | 5.60 | 5.88 | 6.16 | 6.44 | 6.72 |
| 16" | 3.84 | 4.16 | 4.48 | 4.80 | 5.12 | 5.44 | 5.76 | 6.08 | 6.40 | 6.72 | 7.04 | 7.36 | 7.68 |
| 18" | 4.32 | 4.68 | 5.04 | 5.40 | 5.76 | 6.12 | 6.48 | 6.84 | 7.20 | 7.56 | 7.92 | 8.28 | 8.64 |
| 20" | 4.80 | 5.20 | 5.60 | 6.00 | 6.40 | 6.80 | 7.20 | 7.60 | 8.00 | 8.40 | 8.80 | 9.20 | 9.60 |
| 22" | 5.28 | 5.72 | 6.16 | 6.60 | 7.04 | 7.48 | 7.92 | 8.36 | 8.80 | 9.24 | 9.68 | 10.12 | 10.56 |
| 24" | 5.76 | 6.24 | 6.72 | 7.20 | 7.68 | 8.16 | 8.64 | 9.12 | 9.60 | 10.08 | 10.56 | 11.04 | 11.52 |
| 26" | 6.24 | 6.76 | 7.28 | 7.80 | 8.32 | 8.84 | 9.36 | 9.88 | 10.40 | 10.92 | 11.44 | 11.96 | 12.48 |
| 28" | 6.72 | 7.28 | 7.84 | 8.40 | 8.96 | 9.52 | 10.08 | 10.64 | 11.20 | 11.76 | 12.32 | 12.88 | 13.44 |
| 30" | 7.20 | 7.80 | 8.40 | 9.00 | 9.60 | 10.20 | 10.80 | 11.40 | 12.00 | 12.60 | 13.20 | 13.80 | 14.40 |
| 32" | 7.68 | 8.32 | 8.96 | 9.60 | 10.24 | 10.88 | 11.52 | 12.16 | 12.80 | 13.44 | 14.08 | 14.72 | 15.36 |
| 34" | 8.16 | 8.84 | 9.52 | 10.20 | 10.88 | 11.56 | 12.24 | 12.92 | 13.60 | 14.28 | 14.96 | 15.64 | 16.32 |
| 36" | 8.64 | 9.36 | 10.08 | 10.80 | 11.52 | 12.24 | 12.96 | 13.68 | 14.40 | 15.12 | 15.84 | 16.56 | 17.28 |
| 38" | 9.12 | 9.88 | 10.64 | 11.40 | 12.16 | 12.92 | 13.68 | 14.44 | 15.20 | 15.96 | 16.72 | 17.48 | 18.24 |
| 40" | 9.60 | 10.40 | 11.20 | 12.00 | 12.80 | 13.60 | 14.40 | 15.20 | 16.00 | 16.80 | 17.60 | 18.40 | 19.20 |
| 42" | 10.08 | 10.92 | 11.76 | 12.60 | 13.44 | 14.28 | 15.12 | 15.96 | 16.80 | 17.64 | 18.48 | 19.32 | 20.16 |
| 44" | 10.56 | 11.44 | 12.32 | 13.20 | 14.08 | 14.96 | 15.84 | 16.72 | 17.60 | 18.48 | 19.36 | 20.24 | 21.12 |
| 46" | 11.04 | 11.96 | 12.88 | 13.80 | 14.72 | 15.64 | 16.56 | 17.48 | 18.40 | 19.32 | 20.24 | 21.16 | 22.08 |
| 48" | 11.52 | 12.48 | 13.44 | 14.40 | 15.36 | 16.32 | 17.28 | 18.24 | 19.20 | 20.16 | 21.12 | 22.08 | 23.04 |

Options

| Option | Add | 12"H or Less | Over 12" - 48"H |
|--------------|--|------------------------------|-----------------|
| HVBEV | Heavy Beveled Edges | 15.10 | 25.80 |
| BEV | Beveled - No charge included on all plates | | |
| CSK | Countersunk Holes | 1.10 per hundred square inch | |
| SA | Self-Adhesive Mount | 39.60 | 82.00 |
| | CFC | 86.00 | |
| | Cut for Louver | 267.00 | |
| | Notch for Armor | 123.00 | |
| | Add Row of Screws | 38.70 | |
| | UL & WH Listing | 25.10 | |



Cut Installation Time in Half with SELF DRILLING TEK SCREWS

- For US32D Kick Plates SP1050; \$40.10/Hundred Pack.
- For US3 Kick Plates SP1069; \$80.00/Hundred Pack
- Packed with each plate - specify when ordering "by TEK Screws".

| Size | Screws Required | US32D 630 |
|-----------|-----------------|-----------|
| 8" x 34" | 12 | 4.80 |
| 10" x 34" | 12 | 4.80 |
| 12" x 34" | 12 | 4.80 |
| 16" x 34" | 14 | 4.80 |
| 36" x 34" | 22 | 9.70 |

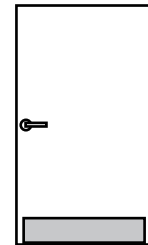

Mop Plate
Up to 8"H x 48"W

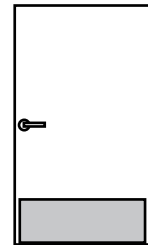

Kick Plate
6" to 12"H x 48"W

Screw Quantity Chart

| Height/Length | 17" - 24" | 25" - 32" | 33" - 40" | 41" - 48" |
|---------------|-----------|-----------|-----------|-----------|
| 4" - 12" | 8 pcs. | 10 pcs. | 12 pcs. | 14 pcs. |
| 13" - 18" | 10 pcs. | 12 pcs. | 14 pcs. | 16 pcs. |
| 19" - 24" | 12 pcs. | 14 pcs. | 16 pcs. | 18 pcs. |
| 25" - 32" | 16 pcs. | 18 pcs. | 20 pcs. | 22 pcs. |
| 33" - 40" | 18 pcs. | 20 pcs. | 22 pcs. | 24 pcs. |
| 40" - 48" | 20 pcs. | 22 pcs. | 24 pcs. | 26 pcs. |



TORX SECURITY SCREWS

- For US32D Kick Plates SP1042; \$121.00/Hundred Pack.
- Packed with each plate - specify when ordering "by TORX Screws".

| Size | Screws Required | US32D 630 |
|-----------|-----------------|-----------|
| 8" x 34" | 12 | 16.90 |
| 10" x 34" | 12 | 16.90 |
| 12" x 34" | 12 | 16.90 |
| 16" x 34" | 14 | 16.90 |
| 36" x 34" | 22 | 30.90 |

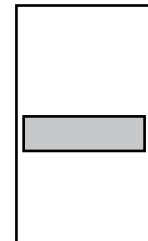

Stretcher Plate
6" to 12"H and up to 48"W

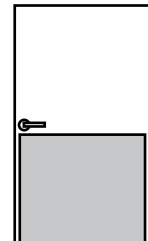

Armor Plate
Up to 48"H x 48"W

ASSA ABLOY

Opening Solutions

The global leader in door opening solutions

Price includes bevel edges!

Door Plates

| Finish | Maximum Size | 8", 10", 12" Height | 4", 6" Special Height <12" | 12.1" ≤ 36" High | 36.1" ≤ 48" High |
|-----------------------|--------------|---------------------|----------------------------|------------------|------------------|
| K1050 | | | | | |
| K1050WS (UL+WS add) | | | | | |
| US32DNF (Nickel Free) | 48" x 48" | 17.80 | 21.30 | 18.30 | 18.30 |
| US32D | 48" x 48" | 19.00 | 22.90 | 19.70 | 19.70 |
| US32DMS | 48" x 48" | 31.20 | 37.40 | 31.80 | 31.80 |
| US32D316 | 40" x 48" | 24.70 | 29.80 | 25.60 | 25.60 |
| US32 | 48" x 48" | 43.10 | 52.00 | 43.80 | 43.80 |
| US3 | 48" x 48" | 65.00 | 77.00 | 82.00 | 99.00 |
| US4 | 48" x 48" | 65.00 | 77.00 | 82.00 | 99.00 |
| US9 | 48" x 48" | 73.00 | 88.00 | 93.00 | 112.00 |
| US10 | 48" x 48" | 78.00 | 94.00 | 94.00 | 113.00 |
| US10B | 48" x 48" | 75.00 | 91.00 | 94.00 | 113.00 |
| 10BE | 48" x 48" | 31.50 | 37.70 | 32.10 | 32.10 |
| US15 | 24" x 48" | 76.00 | 92.00 | | |
| US26D | 24" x 48" | 75.00 | 91.00 | | |
| US26 | 24" x 48" | 75.00 | 91.00 | | |
| US5 | 48" x 48" | 75.00 | 91.00 | 94.00 | 113.00 |
| US28 | 48" x 48" | 18.30 | 21.90 | 18.70 | 18.70 |
| K1038 | | | | | |
| US32D | 48" x 48" | 18.90 | 22.60 | 19.30 | 19.30 |
| K1062 | | | | | |
| 32D | 48" x 48" | 62.00 | 62.00 | 62.00 | 62.00 |
| 32DMS | 48" x 48" | 67.00 | 67.00 | 67.00 | 67.00 |
| 10BE | 48" x 48" | 70.00 | 70.00 | 70.00 | 70.00 |
| K1125 | | | | | |
| US32D | 48" x 48" | 155.00 | 155.00 | 155.00 | 155.00 |
| US3 | 48" x 48" | 306.00 | 306.00 | 306.00 | 306.00 |
| US4 | 48" x 48" | 306.00 | 306.00 | 306.00 | 306.00 |
| US9 | 48" x 48" | 350.00 | 350.00 | 350.00 | 350.00 |
| US10 | 48" x 48" | 329.00 | 329.00 | 329.00 | 329.00 |
| US10B | 48" x 48" | 329.00 | 329.00 | 329.00 | 329.00 |
| 10BE | 48" x 48" | 180.00 | 180.00 | 180.00 | 180.00 |
| US28 | 48" x 48" | 87.00 | 87.00 | 87.00 | 87.00 |
| ALM DIA | 48" x 48" | 90.00 | 90.00 | 90.00 | 90.00 |
| K2125 | | | | | |
| Stock Plastic | 48" x 48" | 50.00 | 50.00 | 50.00 | 50.00 |
| K3125 | | | | | |
| Stock Plastic | 48" x 48" | 22.20 | 22.20 | 22.20 | 22.20 |
| K4125 | | | | | |
| Clear Plastic | 48" x 48" | 22.20 | 22.20 | 22.20 | 22.20 |
| K2060 | | | | | |
| Stock Kydex .060" | 48" x 48" | 24.80 | 28.60 | 24.80 | 24.80 |

OTHER OPTIONS

- Countersunk on .050" Metal Plates add \$1.10 per hundred square inch.
- SA - Self Adhesive Kick Plates 12" high & under add \$39.60 each, over 12" high add \$82.00 each (not available on any US10B size or Brass & Bronze Base Plates over 24" high).

FOR FIRE RATED OPENINGS

- K1050-F* Screw Mounted Plates for steel fire doors rated up to and including 3 hours and wood composite type fire doors rated up to 1 1/2 hours. Available in US32D and all other metal finishes. **Add \$25.10 per plate.** (Maximum Size: 54"H x 46 1/2"W) **UL Approved.**
- K2060SA-F* Self-Adhesive Kydex for 90-minute wood door and 3-hour metal door. **Add \$25.10 per plate.** (Maximum Size: 54"H x 46 1/2"W) **UL Approved.**



* **NFPA 80 STANDARDS — 2-4.5 Protection Plates:** Factory-installed protection plates shall be installed in accordance with the listing of the door. Field-installed protection plates shall be labeled and installed in accordance with their listing. **Exception: Labeling is not required where the top of the protection plate is not more than 16" (406 mm) above the bottom of the door.**

NOTE: Door Plate list pricing is per Hundred Square Inches. Refer to "Hundred Square Inch Size Chart" on page 30 to calculate the list price of each door plate and other available options. See page 41 for special kick plate fasteners.

NOTE: K1050WS plates have a UL and Windstorm price add per plate.

ASSA ABLOY
 Opening Solutions
 The global leader in
 door opening solutions



K1050-1 - K1050-8 & K1050A-1 - K1050A-8 (.050" Thick) Shaped Metal Plates Add-On Chart

| Add unit price below to list price for kick plate from above chart. Prices are based on same size and same shape. | |
|---|---|
| Pieces | Pricing |
| 1 - 10 Pieces | Email Dimensions and Quantities for Pricing |
| 11 - 20 Pieces | Email Dimensions and Quantities for Pricing |
| 21+ Pieces | Email Dimensions and Quantities for Pricing |

To calculate Shapes™ metal plate price use the largest height x width dimension of the size required to make your design. Refer to "Hundred Square Inch Size Chart" on page 30 and the list price for 32D K1050 kick plates above. Then add the per plate charge supplied by the factory.

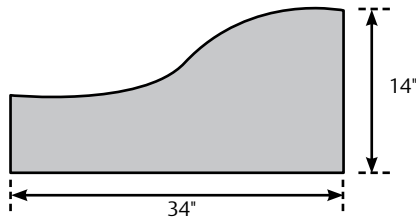

**Example:
14" x 34" Plate Calculation**

| QUICK SHIP KICK PLATES | | | |
|---|--------|-------|---------------|
| Part | Height | Width | US32D/630 |
| 8x34BEV.32D | 8" | 34" | 50.00 |
| 10x34BEV.32D | 10" | 34" | 63.00 |
| 34x34BEV.32D | 34" | 34" | 220.00 |
| <ul style="list-style-type: none"> • Beveled Edge and Counter Sink included • One day shipping available • Door markings are not available on quick ship | | | |

Architectural Finishes

Most of Rockwood's products are available in all of the following architectural finishes. The catalog indicates exceptions. This finish list is grouped by base metal.

| Base Metal | Description | Price Book Code | Rockwood Code | BHMA Code |
|--|--|-----------------|---------------|-----------|
| Aluminum | Satin | 27 | US27 | 627 |
| Aluminum | Clear Anodized | 28 | US28 | 628 |
| Aluminum | Light Bronze Anodized | 311 | 311 | — |
| Aluminum | Medium Bronze Anodized | 312 | 312 | — |
| Aluminum | Dark Bronze Anodized | 313 | 313 | 710 |
| Aluminum | Extra Dark Bronze Anodized | 314 | 314 | — |
| Aluminum | Black Anodized | 315 | 315 | 711 |
| Aluminum | White Powder Coat | WPC | WPC | — |
| Aluminum | Red Powder Coat | RPC | RPC | — |
| Aluminum | Black Powder Coat | BPC | BPC | — |
| Brass | Polished Clear Coated | 3 | US3 | 605 |
| Brass | Polished No Coating | 3NL | US3NL | — |
| Brass | Satin Clear Coated | 4 | US4 | 606 |
| Brass | Satin Oxidized Relieved | 5 | US5 | 609 |
| Brass | Satin Nickel Plated Clear Coated | 15 | US15 | 619 |
| Brass | Satin Nickel Blackened Relieved Clear Coated | 15A | US15A | 620 |
| Brass | Flat Black Powder Coated | 19 | US19 | 622 |
| Brass | Polished Chrome Plated | 26 | US26 | 625 |
| Brass | Satin Chrome Plated | 26D | US26D | 626 |
| Bronze* | Polished Clear Coated | 9 | US9 | 611 |
| Bronze* | Satin Clear Coated | 10 | US10 | 612 |
| Bronze* | Satin Black Oxidized Oil Rubbed | 10A | US10A | 722 |
| Bronze* | Satin Oxidized Oil Rubbed | 10B | US10B | 613 |
| Bronze* | Satin Oxidized Clear Coated | 10BL | US10BL | 614 |
| Bronze* | Dark Oxidized Statuary Clear Coated | 20A | US20A | 624 |
| Stainless Steel | Polished | 32 | US32 | 629 |
| Stainless Steel | Satin | 32D | US32D | 630 |
| Special Finishes (see descriptions) | | | | |
| Stainless Steel | Satin MicroShield® Coated | 32DMS*** | US32DMS*** | — |
| Stainless Steel | Polished 316 Alloy | 32316*** | US32316*** | — |
| Stainless Steel | Satin 316 Alloy | 32D316*** | US32D316*** | — |
| | Dark Oxidized Satin Bronze, Equivalent | 10BE | US10BE | (613E) |
| | Black Suede Powder Coat | BSP | BSP | — |
| | White Suede Powder Coat | WSP | WSP | — |
| | Wrought Black Powder Coat | WB | WB | — |

Special Finishes Description

32DMS (MicroShield®): As part of its promise to provide innovative solutions to their customers, ASSA ABLOY Group companies offer the MicroShield® technology, a silver-based antimicrobial coating designed to inhibit the spread of germs and bacteria.

32316 and **32D316** are made from alloy 316 stainless steel containing molybdenum and extra nickel giving it substantially higher corrosion resistance than the standard stainless steels typically used in door hardware. This finish is ideal for use in coastal, urban, and industrial areas that have harsh environmental conditions. **32316** (polish) finishes offer the best corrosion resistance and should be used in caustic environments.

10BE Dark Oxidized Satin Bronze equivalent: This finish provides the richness and warmth of the 10B/613 "living" finish, but maintains its original color and appearance and will not fade or wear over time. The 10BE finish is offered by Corbin Russwin, McKinney, Norton, Rixson, Rockwood, SARGENT and Yale, providing visual consistency between ASSA ABLOY Group brands.

* On most bronze finishes we will supply solid bronze material. Where solid bronze material is not available, we will use brass as a base material with a bronze look powder coat in its place.

*** Available on select items as indicated by the finish icon throughout the catalog.



MicroShield® is a registered trademark of Yale Security Inc., an ASSA ABLOY Group company.

Set Mounting Charges

| Mounting Spec # | Door Type | Pull Type | Mounting Type | | | Add On |
|-----------------|--------------|--------------------|---------------|---------------|------------|----------|
| | | | Pull Free End | Push Free End | Common End | |
| T1 | Metal & Wood | Straight or Offset | 12 | 12 | 5 | 63.15 |
| T1HD | Metal & Wood | Straight or Offset | 12HD | 12HD | 5HD | 77.15 |
| T2 | Glass | Straight or Offset | 15 | 15 | 13 | 80.05 |
| T2HD | Glass | Straight or Offset | 15HD | 15HD | 13HD | 96.05 |
| T3* | Metal & Wood | Straight or Offset | 1 | 1 | 5 | Included |
| T3HD | Metal & Wood | Straight or Offset | 1HD | 1HD | 5HD | 28.45 |
| T4 | Metal | Straight | 6 | 6 | 5 | 24.45 |
| T4HD | Metal | Straight | 6HD | 6HD | 5HD | 36.45 |
| T4 | Metal | Offset | 17 | 17 | 16 | 36.45 |
| T4HD | Metal | Offset | 17HD | 17HD | 16HD | 45.15 |
| T5 | Wood | Straight or Offset | 8 | 8 | 5 | 29.65 |

*T3 is the standard mounting method for Metal and Wood Doors.

NOTE: Heavy Duty (HD) mounting features hex drive for positive tightening and large overall size for superior strength. Recommended for high frequency and rough service openings.

Mounting Types

| Pull Style | PULL ON ONE SIDE OF DOOR | | | | | | | | PULL ON BOTH SIDES OF DOOR (BTB) | | | | |
|----------------------------------|--------------------------|----------|----------------|----------|-----------|----------|----------|----------|----------------------------------|----------|----------|----------|-----------|
| | Thru Bolt | | Deco Thru Bolt | | Concealed | | | | Conehead/Set Screw | | | | Lug Plate |
| Mounting Style | Wood/Metal | | Glass | | Metal | | Wood | | Wood/Metal | | Glass | | Any |
| Door Type | Wood/Metal | | Glass | | Metal | | Wood | | Wood/Metal | | Glass | | Any |
| Coneheads | NA | NA | NA | Single | Single | Single | Double | Double | Single | Double | Single | Double | Single |
| Mounting Type | Type 1 | Type 12 | Type 15 | Type 6 | Type 6R | Type 8 | Type 17 | Type 17R | Type 5 | Type 16 | Type 13 | Type 18 | Type 9 |
| Standard (STD) Bolt Size | 1/4"-20 | 1/4"-20 | 1/4"-20 | 1/4"-20 | 1/4"-20 | 1/4"-20 | 1/4"-20 | 1/4"-20 | 1/4"-20 | 1/4"-20 | 1/4"-20 | 1/4"-20 | 1/4"-20 |
| Price | INCL | 55.00 | 65.00 | 16.30 | 25.80 | 21.50 | 24.30 | 34.40 | 16.30 | 24.30 | 30.10 | 41.70 | 54.00 |
| Heavy Duty (HD) Bolt Size | 5/16"-18 | 5/16"-18 | 5/16"-18 | 5/16"-18 | 5/16"-18 | 5/16"-18 | 5/16"-18 | 5/16"-18 | 5/16"-18 | 5/16"-18 | 5/16"-18 | 5/16"-18 | |
| Price | 16.30 | 65.00 | 77.00 | 24.30 | 36.60 | 30.10 | 30.10 | 43.00 | 24.30 | 30.10 | 38.10 | 47.70 | |
| Extra Heavy Duty (XHD) Bolt Size | 3/8"-16 | 3/8"-16 | 3/8"-16 | | | | | | | | | | |
| Price | 23.90 | 71.00 | 83.00 | | | | | | | | | | |

Straight Pulls

| Pull Type | Dia. | MAXIMUM BOLT SIZE ALLOWED | | | | | | | MAXIMUM BOLT SIZE ALLOWED | | | | | |
|-----------|------|---------------------------|---------|---------|--------|---------|--------|---------|---------------------------|--------|---------|---------|---------|--------|
| | | Type 1 | Type 12 | Type 15 | Type 6 | Type 6R | Type 8 | Type 17 | Type 17R | Type 5 | Type 16 | Type 13 | Type 18 | Type 9 |
| Straight | 1/2" | STD | STD | STD | | | STD | | | | | STD | | |
| Straight | 5/8" | HD | HD | HD | STD | | STD | | | | | STD | | STD |
| Straight | 1" | HD | HD | HD | HD | HD | HD | | | | | HD | | STD |

Offset Pulls

| Pull Type | Dia. | MAXIMUM BOLT SIZE ALLOWED | | | | | | | MAXIMUM BOLT SIZE ALLOWED | | | | | |
|-----------|--------|---------------------------|---------|---------|--------|---------|--------|---------|---------------------------|--------|---------|---------|---------|--------|
| | | Type 1 | Type 12 | Type 15 | Type 6 | Type 6R | Type 8 | Type 17 | Type 17R | Type 5 | Type 16 | Type 13 | Type 18 | Type 9 |
| Offset | 1/2" | STD | STD | STD | | | | | | | | STD | | |
| Offset | 5/8" | HD | HD | HD | | | | | | | | STD | | |
| Offset | 1" | XHD | XHD | XHD | | | | HD | STD | | | HD | | |
| Offset | 1 1/4" | XHD | XHD | XHD | | | | HD | STD | | | HD | | |

NOTE: Heavy Duty (HD) mounting features hex drive for positive tightening and large overall size for superior strength. Recommended for high frequency and rough service openings.

Free End Thru Bolt

TYPE 1 - Thru Bolt Wood or Metal Door

| Type | Bolt Size | Drill Size | Price |
|------|-----------|------------|-------|
| 1 | 1/4"-20 | 9/32 | Incl. |
| 1HD | 5/16"-18 | 11/32 | 16.30 |
| 1XHD | 3/8"-16 | 13/32 | 23.90 |

TYPE 12 - Decorative Thru Bolt Wood or Metal Door

| Type | Bolt Size | Drill Size | Price |
|-------|-----------|------------|-------|
| 12 | 1/4"-20 | 9/32 | 55.00 |
| 12HD | 5/16"-18 | 11/32 | 65.00 |
| 12XHD | 3/8"-16 | 13/32 | 71.00 |

TYPE 15 - Decorative Thru Bolt Glass Door

| Type | Bolt Size | Drill Size | Price |
|-------|-----------|------------|-------|
| 15 | 1/4"-20 | 5/8 | 65.00 |
| 15HD | 5/16"-18 | 5/8 | 77.00 |
| 15XHD | 3/8"-16 | 5/8 | 83.00 |

Free End Concealed

TYPE 6 - Surface Concealed Metal Door

Minimum diameter of pull is 5/8"

For doors with rivnuts specify Type 6R
Reinforcement by others

| Type | Bolt Size | Drill Size | Price |
|------|-----------|--------------|-------|
| 6 | 1/4"-20 | 1/4"-20 Tap | 16.30 |
| *6HD | 5/16"-18 | 5/16"-18 Tap | 24.30 |

TYPE 6R - Surface Concealed Metal Door

Minimum diameter of pull is 1"

| Type | Bolt Size | Drill Size | Price |
|------|-----------|------------|-------|
| 6 | 1/4"-20 | N/A | 25.80 |
| *6HD | 5/16"-18 | N/A | 36.60 |

TYPE 8 - Surface Concealed Wood Door

| Type | Bolt Size | Drill Size | Price |
|------|-----------|-----------------|-------|
| 8 | 1/4"-20 | 23/64"-9/16 dp. | 21.50 |
| *8HD | 5/16"-18 | 7/16"-9/16 dp. | 30.10 |

TYPE 17 - Surface Concealed Metal Door

Minimum diameter of pull is 1"

Reinforcement by others

| Type | Bolt Size | Drill Size | Price |
|------|-----------|--------------|-------|
| 17 | 1/4"-20 | 1/4"-20 Tap | 24.30 |
| 17HD | 5/16"-18 | 5/16"-18 Tap | 30.10 |

TYPE 17R - Surface Concealed Metal Door

Minimum diameter of pull is 1"

| Type | Bolt Size | Drill Size | Price |
|-------|-----------|------------|-------|
| 17R | 1/4"-20 | N/A | 34.40 |
| 17RHD | 5/16"-18 | N/A | 43.00 |

*HD mountings feature 2 set screws 180° apart.

NOTE: Y base plates are recommended on wood or glass doors to make a stable and durable mounting (see page 40 for details).
 NOTE: Heavy Duty (HD) mounting features hex drive for positive tightening and large overall size for superior strength.
 Recommended for high frequency and rough service openings.

Flush Pull Mounting

Type 10 Mounting applies to the 94 Series Flush Pulls

TYPE 10 - Surface Mounted Wood or Metal Door

| Type | Bolt Size | Drill Size | Price |
|------|-----------|------------|-------|
| 10 | #8-32 | 9/32 | 30.10 |

Wire or Small Post Mount Pull Mounting

NOTE: This mounting should only be used on pulls with mounting points that are 1/2" in diameter.

TYPE 55 - Back-to-Back Wood or Metal Door

| Type | Bolt Size | Drill Size | Price |
|------|-----------|------------|-------|
| 55 | #8-32 | 13/64 | 30.10 |

Common End Back-to-Back

TYPE 5 - Back-to-Back Wood or Metal Door
 Minimum diameter of pull is 5/8"

| Type | Bolt Size | Drill Size | Price |
|------|-----------|------------|-------|
| 5 | 1/4"-20 | 9/32 | 16.30 |
| 5HD | 5/16"-18 | 11/32 | 24.30 |

TYPE 9 - Back-to-Back w/Lug Plate Any Door Type
 Minimum diameter of pull is 5/8"

| Type | Bolt Size | Drill Size | Price |
|------|-----------|------------|-------|
| 9 | 1/4"-20 | N/A | 54.00 |

TYPE 11XHD - Back-to-Back w/Spanner Collar - Wood or Metal Door
 Minimum diameter of pull is 1"

| Type | Bolt Size | Drill Size | Price |
|-------|-----------|------------|-------|
| 11XHD | 3/8"-16 | 13/32 | 62.00 |

TYPE 13 - Back-to-Back Glass Door

| Type | Bolt Size | Drill Size | Price |
|-------|-----------|------------|-------|
| 13 | 1/4"-20 | 5/8 | 30.10 |
| *13HD | 5/16"-18 | 5/8 | 38.10 |

TYPE 14XHD - Back-to-Back Glass Door
 Minimum diameter of pull is 1"

| Type | Bolt Size | Drill Size | Price |
|-------|-----------|------------|-------|
| 14XHD | 3/8"-16 | 5/8 | 67.00 |

TYPE 16 - Back-to-Back Wood or Metal Door
 1" diameter offset pulls only

| Type | Bolt Size | Drill Size | Price |
|------|-----------|------------|-------|
| 16 | 1/4"-20 | 9/32 | 24.30 |
| 16HD | 5/16"-18 | 11/32 | 30.10 |

TYPE 18 - Back-to-Back Glass Door

| Type | Bolt Size | Drill Size | Price |
|------|-----------|------------|-------|
| 18 | 1/4"-20 | 5/8 | 41.70 |
| 18HD | 5/16"-18 | 5/8 | 47.70 |

*HD mountings feature 2 set screws 180° apart.

Push and Pull Bar Mounting Details

Sizing of Push Bars

Flush Doors

- Door width: • minus 5" for bent end bars
 • minus 5" for square end post mount bars
 • minus 7" for round end post mount bars

Stile and Rail Doors or Doors with Lites

- Door width: • minus width of one stile

CAUTION: Always confirm bars will not interfere with jamb or cause pinching hazard.

CAUTION: On narrow stile doors, be sure push bar base fits on the stile and bar does not interfere with the stop.

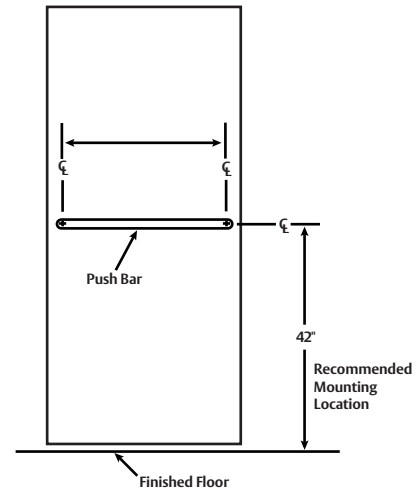

Handing of Doors

The handing of a door is determined from the outside of the opening.

Standing outside the door:

- If the hinges are on the right, it is a right hand door.
- If the hinges are on the left, it is a left hand door.
- If the door opens away from you, it is a regular bevel door.
- If the door opens toward you, it is a reverse bevel door.

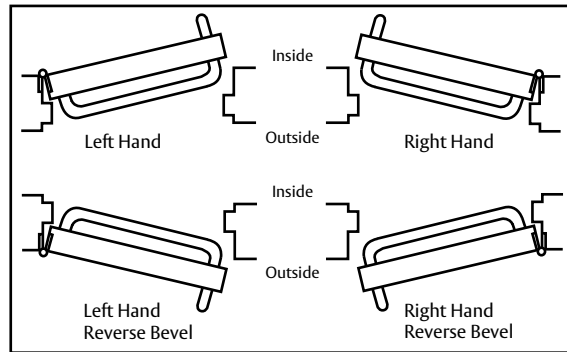

TYPICAL MOUNTING

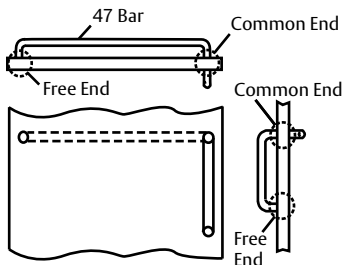

Thru Bolt Mounting - For 1 3/4" Wood and Metal Doors

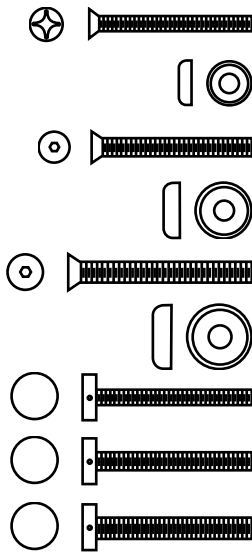

| Part | Description | Mounting Type | Price |
|--------|--|---------------|-------|
| SP1004 | 1/4"-20 x 2 1/4" Flat Head Machine Screw Thru Bolt | 1 | 2.40 |
| SP1005 | 1/4"-20 Finishing Washer | 1 | 1.70 |
| SP1053 | 5/16"-18 x 2 1/2" Socket Flat Head Machine Screw Thru Bolt | 1HD | 6.60 |
| SP1054 | 5/16"-18 Finishing Washer | 1HD | 2.40 |
| SP1001 | 3/8"-16 x 2 1/2" Socket Flat Head Machine Screw Thru Bolt | 1XHD | 10.20 |
| SP1002 | 3/8"-16 Finishing Washer | 1XHD | 3.00 |
| SP1003 | 1" Diameter Decorative Thru Bolt 1/4"-20 x 2 1/4" | 12 | 27.60 |
| SP1055 | 1" Diameter Decorative Thru Bolt 5/16"-18 x 2 1/4" | 12HD | 32.80 |
| SP1041 | 1 1/4" Diameter Decorative Thru Bolt 3/8"-16 x 2 1/4" | 12XHD | 32.80 |

Back-to-Back Mounting - For 1 3/4" Wood and Metal Doors

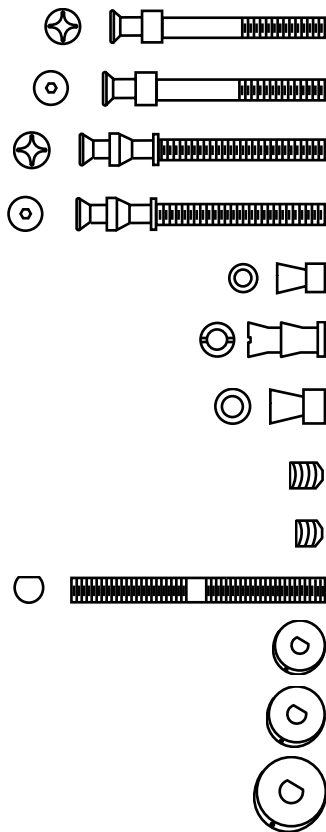

| Part | Description | Mounting Type | Price |
|--------|---|---------------|-------|
| SP1025 | 1/4"-20 x 2 1/4" Cone Head Machine Screw | 5 | 7.20 |
| SP1056 | 5/16"-18 x 2 1/4" Cone Head Machine Screw | 5HD | 11.30 |
| SP1052 | 1/4"-20 x 2 1/4" Double Cone Head Machine Screw (for use with offset pulls) | 16 | 8.50 |
| SP1057 | 5/16"-18 x 2 1/4" Double Cone Head Machine Screw (for use with offset pulls) | 16HD | 13.90 |
| SP1027 | 1/4"-20 Cone Head Union (Used to Convert Cone Head to Thru Bolt Hole) | N/A | 7.20 |
| SP1079 | 1/4"-20 Double Cone Head Union (Used to Convert Double Cone Head to Thru Bolt Hole) | N/A | 12.60 |
| SP1068 | 5/16"-18 Cone Head Union (Used to Convert Cone Head to Thru Bolt Hole) | N/A | 11.30 |
| SP1026 | 1/4"-20 x 5/16" Set Screws (Standard) | N/A | 1.70 |
| SP1065 | 1/4"-20 x 3/16" Set Screw (Short) | N/A | 2.20 |
| SP1032 | 3/8"-16 x 3 1/2" LH/RH Bolt | 11 | 14.90 |
| SP1071 | Spanner Collar 1" Diameter for LH/RH Bolt | 11 | 22.60 |
| SP1033 | Spanner Collar 1 1/4" Diameter for LH/RH Bolt | 11 | 22.60 |
| SP1072 | Spanner Collar 1 1/2" Diameter for LH/RH Bolt | 11 | 25.10 |

Concealed Mounting - For 1 3/4" Wood and Metal Doors

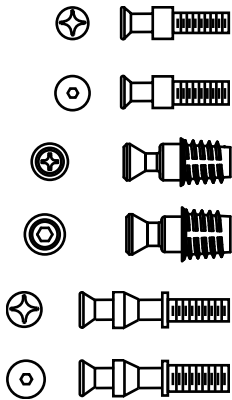

| Part | Description | Mounting Type | Price |
|--------|--|---------------|-------|
| SP1039 | 1/4"-20 x 1/2" Cone Head Machine Screw | 6 / 6R | 7.20 |
| SP1058 | 5/16"-18 x 1/2" Cone Head Machine Screw | 6HD | 11.30 |
| SP1080 | 1/4"-20 Cone Head / Knife Thread Insert | 8 | 11.90 |
| SP1082 | 5/16"-18 Cone Head / Knife Thread Insert | 8HD | 11.90 |
| SP1051 | 1/4"-20 x 1/2" Double Cone Head Machine Screw | 17 / 17R | 11.30 |
| SP1059 | 5/16"-18 x 1/2" Double Cone Head Machine Screw | 17HD | 13.90 |

Bushings & Washers - For 1/2" Glass Doors

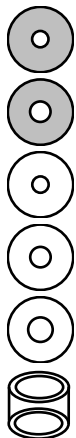

| Part | Description | Mounting Type | Price |
|--------|---|----------------|-------|
| SP1022 | Stainless Steel Washer for 1/4"-20 Cone Head Machine Screw .032" Thick | 13 | 3.00 |
| SP1060 | Stainless Steel Washer for 5/16"-18 Cone Head Machine Screw .060" Thick | 13HD | 3.00 |
| SP1023 | Plastic Washer for 1/4"-20 Bolt; Specify Size | 13 | 2.60 |
| SP1061 | Plastic Washer for 5/16"-18 Bolt; Specify Size | 13HD | 2.80 |
| SP1062 | Plastic Washer for 3/8"-16 Bolt; Specify Size | 14 | 2.80 |
| SP1024 | Glass Door Bushing for 5/8" Hole in Glass; Specify Size | 13 / 13HD / 14 | 3.00 |

Thru Bolt Mounting - For 1/2" Glass Doors

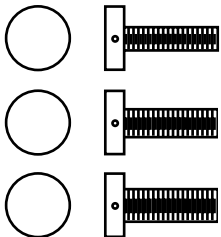

| Part | Description | Mounting Type | Price |
|--------|--|---------------|-------|
| SP1020 | 1" Diameter Decorative Thru Bolt; 1/4"-20 x 1 1/8" | 15 | 27.60 |
| SP1063 | 1" Diameter Decorative Thru Bolt; 5/16"-18 x 1 1/8" | 15HD | 32.80 |
| SP1040 | 1 1/4" Diameter Decorative Thru Bolt; 3/8"-16 x 1 1/8" | 15XHD | 32.80 |

Back-to-Back Mounting - For 1/2" Glass Doors

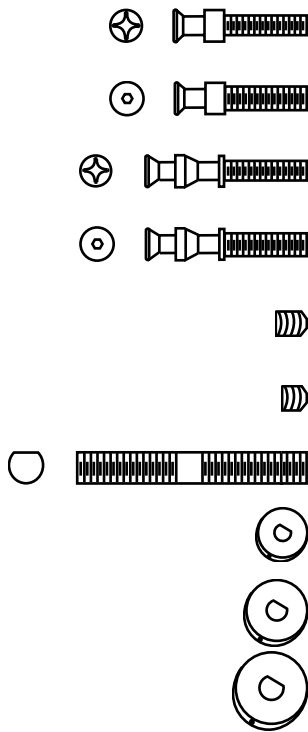

| Part | Description | Mounting Type | Price |
|--------|--|---------------|-------|
| SP1021 | 1/4"-20 x 1 1/8" Cone Head Machine Screw | 13 | 7.20 |
| SP1064 | 5/16"-18 x 1 1/8" Cone Head Machine Screw | 13HD | 11.30 |
| SP1067 | 1/4"-20 x 1 1/8" Double Cone Head Machine Screw | 18 | 11.30 |
| SP1066 | 5/16"-18 x 1 1/8" Double Cone Head Machine Screw | 18HD | 13.90 |
| SP1026 | 1/4"-20 x 5/16" Set Screw (Standard) | N/A | 1.70 |
| SP1065 | 1/4"-20 x 3/16" Set Screw (Short) | N/A | 2.20 |
| SP1031 | 3/8"-16 x 1 3/4" LH/RH Bolt | 14 | 14.90 |
| SP1071 | Spanner Collar 1" Diameter for LH/RH Bolt | 14 | 22.60 |
| SP1033 | Spanner Collar 1 1/4" Diameter for LH/RH Bolt | 14 | 22.60 |
| SP1072 | Spanner Collar 1 1/2" Diameter for LH/RH Bolt | 14 | 25.10 |

Y Base Plates

Specify bolt hole size and finish. Standard pulls require two plates.

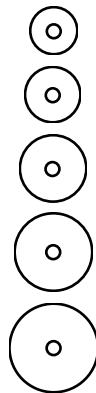

| Part | Description | For Use With | Price |
|--------|-------------------------------|-----------------------------|-------|
| SP1073 | 1/8" Thick x 1 1/16" Diameter | 3/4" Diameter Pulls | 27.60 |
| SP1074 | 1/8" Thick x 1 1/4" Diameter | 1" Diameter Pulls and Posts | 27.60 |
| SP1075 | 1/8" Thick x 1 1/2" Diameter | 1" Diameter Pulls and Posts | 27.60 |
| SP1076 | 1/8" Thick x 1 3/4" Diameter | 1" Diameter Pulls and Posts | 27.60 |
| SP1077 | 1/8" Thick x 2" Diameter | 1" Diameter Pulls and Posts | 27.60 |

Flush Pull Fasteners

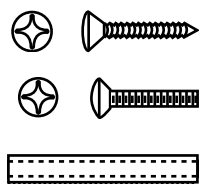

| Part | Description | Door Type | Price |
|--------|---|---------------|-------|
| SP1006 | #8 x 3/4" Oval Head Sheet Metal Screw | Wood or Metal | 1.30 |
| SP1007 | #8-32 x 3/4" Oval Head Machine Screw | Metal | 1.30 |
| SP1034 | #8-32 x 1 5/8" Brass Sleeve Machine Screw | Wood or Metal | 7.60 |

Plate Fasteners

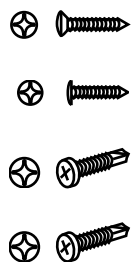

| Part | Description | For Use With | Price |
|--------|---|--------------------------------------|----------|
| SP1008 | #6 x 5/8" Oval Head Sheet Metal Screw | Push and Pull Plates; Kick Plates | 34.90/c |
| SP1009 | #6 x 3/4" Truss Head Sheet Metal Screw | Plastic / Laminate Kick Plates | 34.90/c |
| SP1050 | #6 x 5/8" Pan Head (TEK) Self-Drilling Screw - Stainless Steel | Stainless Steel Kick Plates | 87.90/c |
| SP1069 | #6 x 5/8" Pan Head (TEK) Self-Drilling Screw - Brass Plated | Brass Kick Plates | 161.60/c |

Sex Nuts

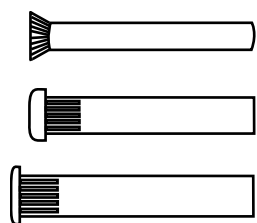

| Part | Description | For Use With | Price |
|--------|---------------------------|------------------------------|-------|
| SP1018 | #8-32 Flat Head Sex Nut | 94 Series Flush Pulls | 10.20 |
| SP1019 | #10-24 x 1 9/16" Sex Nut | 580 Surface Bolts | 5.90 |
| SP1070 | 1/4"-20 x 1 9/16" Sex Nut | 585 Surface Bolts | 13.90 |

Tamperproof Torx® Head Security Fasteners

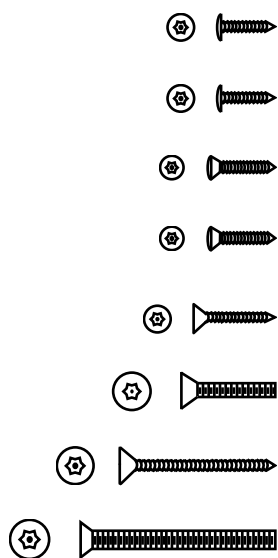

| Part | Description | For Use With | Price |
|---------|---|---|-------|
| SP1016 | #6 x 1/2" Button Head Sheet Metal Screw | Plastic Plates | 1.70 |
| SP1016B | #6 x 1/2" Button Head Sheet Metal Screw Brass Plated | Kick Plates | 4.90 |
| SP1042 | #6 x 5/8" Oval Head Sheet Metal Screw | Kick Plates and Push/Pull Plates (Stainless Steel) | 1.70 |
| SP1042B | #6 x 5/8" Oval Head Sheet Metal Screw Brass Plated | Kick Plates and Push/Pull Plates | 6.30 |
| SP1017 | #8 x 3/4" Flat Head Sheet Metal Screw | 94 Flush Pulls, 131 Door Pulls, and 555 Flush Bolts | 4.10 |
| SP1035 | #8-32 x 3/4" Flat Head Machine Screw | 94 Flush Pulls, 131 Door Pulls, and 555 Flush Bolts | 4.40 |
| SP1037 | #12 x 1 1/2" Flat Head Wood Screw | 440/442 Door Stops | 4.90 |
| SP1038 | 1/4"-20 x 2 1/2" Flat Head Machine Screw | Door Pulls Type 1 Mount | 7.60 |

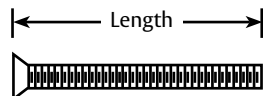
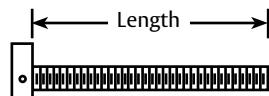
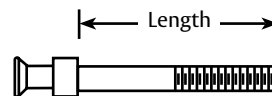
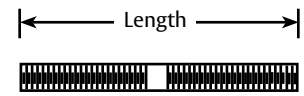
Standard Thru Bolt for
Countersunk HolesDecorative Thru Bolt for
Wood or Metal DoorsCone Head Bolt for Back-to-Back
Wood or Metal Doors

LH/RH Bolt without Heads

Mounting Kits for Door Pulls

| Part | Mounting Type | Description | Price |
|---------------|---------------|--|-------|
| KIT1 | 1 | 2 ea. 1/4"-20 x 2 1/4" Thru Bolts and 2 ea. Finish Washers; Specify Finish | 8.30 |
| KIT1HD | 1HD | 2 ea. 5/16"-18 x 2 1/2" Thru Bolts and 2 ea. Finish Washers; Specify Finish | 16.50 |
| KIT1XHD | 1XHD | 2 ea. 3/8"-16 x 2 1/2" Thru Bolts and 2 ea. Finish Washers; Specify Finish | 24.10 |
| KIT5 | 5 | 2 ea. 1/4"-20 x 2 1/4" Cone Head Bolts and 4 ea. Set Screws | 16.50 |
| KIT5HD | 5HD | 2 ea. 5/16"-18 x 2 1/4" Cone Head Bolts and 4 ea. Set Screws | 24.50 |
| KIT6 | 6 | 2 ea. 1/4"-20 x 1 1/2" Cone Head Bolts and 4 ea. Set Screws | 16.50 |
| KIT6HD | 6HD | 2 ea. 5/16"-18 x 1 1/2" Cone Head Bolts and 4 ea. Set Screws | 24.50 |
| KIT11 | 11 | 2 ea. 3/8"-16 x 3 1/2" LH/RH Bolt and 2 ea. Spanner Collars for 1 3/4" Doors; Specify Pull Diameter and Finish | 62.60 |
| KIT12-1 | 12 | 2 ea. 1/4"-20 x 2 1/4" Decorative Thru Bolts; 1" Dia.; Specify Finish | 55.60 |
| KIT12-1HD | 12HD | 2 ea. 5/16"-18 x 2 1/4" Decorative Thru Bolts; 1" Dia.; Specify Finish | 65.70 |
| KIT12-1.25XHD | 12XHD | 2 ea. 3/8"-16 x 2 1/4" Decorative Thru Bolts; 1 1/4" Dia.; Specify Finish | 71.70 |
| KIT12-1.5XHD | 12XHD | 2 ea. 3/8"-16 x 2 1/4" Decorative Thru Bolts; 1 1/2" Dia.; Specify Finish | 83.80 |
| KIT13 | 13 | 2 ea. 1/4"-20 x 1 1/8" Cone Head Bolts; 2 ea. Metal Washers; 4 ea. Plastic Washers; 2 ea. Bushings for 1/2" Glass Doors; 4 ea. Set Screws; Specify if other than 1/2" Glass | 30.40 |
| KIT13HD | 13HD | 2 ea. 5/16"-18 x 1 1/8" Cone Head Bolts; 2 ea. Metal Washers; 4 ea. Plastic Washers; 2 ea. Bushings for 1/2" Glass Doors; 4 ea. Set Screws; Specify if other than 1/2" Glass | 38.50 |
| KIT14 | 14 | 2 ea. 3/8"-16 x 2 1/4" LH/RH Bolt; 2 ea. Spanner Collars; 2 ea. Bushings; 4 ea. Washers for 1/2" Glass Doors; Specify Pull Diameter and Finish | 74.70 |
| KIT15 | 15 | 2 ea. 1/4"-20 x 1 1/8" Decorative Thru Bolts; 1" Dia.; 2 ea. Bushings; 4 ea. Plastic Washers; Specify Finish and Glass Thickness/Hole Size | 65.70 |
| KIT15HD | 15HD | 2 ea. 5/16"-18 x 1 1/8" Decorative Thru Bolts; 1" Dia.; 2 ea. Bushings; 4 ea. Plastic Washers; Specify Finish and Glass Thickness/Hole Size | 77.80 |
| KIT15-1.25XHD | 15XHD | 2 ea. 3/8"-16 x 1 1/8" Decorative Thru Bolts; 1 1/4" Dia.; 2 ea. Bushings; 4 ea. Plastic Washers; Specify Finish and Glass Thickness/Hole Size | 83.80 |
| KIT15-1.5XHD | 15XHD | 2 ea. 3/8"-16 x 1 1/8" Decorative Thru Bolts; 1 1/2" Dia.; 2 ea. Bushings; 4 ea. Plastic Washers; Specify Finish and Glass Thickness/Hole Size | 96.00 |
| KIT16 | 16 | 2 ea. 1/4"-20 x 2 1/4" Double Cone Head Bolts and 4 ea. Set Screws | 24.50 |
| KIT16HD | 16HD | 2 ea. 5/16"-18 x 2 1/4" Double Cone Head Bolts and 4 ea. Set Screws | 30.40 |

| Part | Mounting Type | Description | Price |
|-----------|---------------|---|--------|
| KIT17 | 17 | 2 ea. 1/4"-20 x 1 1/2" Double Cone Head Bolts and 4 ea. Set Screws | 24.50 |
| KIT17HD | 17HD | 2 ea. 5/16"-18 x 1 1/2" Double Cone Head Bolts and 4 ea. Set Screws | 30.40 |
| KIT18 | 18 | 2 ea. 1/4"-20 x 1 1/8" Double Cone Head Bolts; 2 ea. Metal Washers; 4 ea. Plastic Washers; 2 ea. Bushings for 1/2" Glass Doors; Specify if other than 1/2" Glass and 4 ea. Set Screws | 42.10 |
| KIT18HD | 18HD | 2 ea. 5/16"-18 x 1 1/8" Double Cone Head Bolts; 2 ea. Metal Washers; 4 ea. Plastic Washers; 2 ea. Bushings for 1/2" Glass Doors; Specify if other than 1/2" Glass and 4 ea. Set Screws | 48.20 |
| KIT-T1 | T1 | 1 ea. 1/4"-20 x 2 1/4" Cone Head Bolt; 1 ea. 1/4"-20 Cone Head Union; 2 ea. Set Screws; 2 ea. 1/4"-20 x 2 1/4" — 1" Dia. Decorative Thru Bolts; Specify Finish | 71.70 |
| KIT-T2 | T2 | 1 ea. 1/4"-20 x 1 1/8" Cone Head Bolt; 1 ea. 1/4"-20 Cone Head Union; 2 ea. Set Screws; 2 ea. 1/4"-20 x 1 1/8" — 1" Dia. Decorative Thru Bolts; 1 ea. Metal Washer; 6 ea. Plastic Washers; 3 ea. Bushings; Specify Finish | 89.90 |
| KIT-T3 | T3 | 1 ea. 1/4"-20 x 2 1/4" Cone Head Bolt; 1 ea. 1/4"-20 Cone Head Union; 2 ea. Set Screws; 2 ea. 1/4"-20 x 2 1/4" Thru Bolts; 2 ea. Finish Washers; Specify Finish | 24.50 |
| KIT-T4 | T4 | 1 ea. 1/4"-20 x 2 1/4" Cone Head Bolt; 2 ea. 1/4"-20 x 1 1/2" Cone Head Bolts; 3 ea. Set Screws | 24.50 |
| KIT-T5 | T5 | 1 ea. 1/4"-20 x 2 1/4" Cone Head Bolt; 2 ea. 1/4"-20 x 1 1/2" Cone Head Wood Screws; 3 ea. Set Screws | 24.50 |
| KITRM1.25 | 11x1XHD | 2 ea. 3/8"-16 x 2 1/2" Thru-Bolts; 2 ea. Finish Washers; 1 ea. 3/8"-16 x 3 1/2" LH/RH Bolt; 1 ea. 1 1/4" Spanner Collar; Specify Finish | 55.60 |
| KITRM360 | 11x12XHD | 2 ea. 3/8"-16 x 2 1/4" Decorative Thru Bolts 1 1/4" Dia.; 1 ea. 3/8"-16 x 3 1/2" LH/RH Bolt; 1 ea. 1 1/4" Spanner Collar; Specify Finish | 103.00 |
| KITRM360G | 14x15XHD | 2 ea. 3/8"-16 x 2 1/4" Decorative Thru Bolts 1 1/4" Dia.; 1 ea. 3/8"-16 x 3 1/2" LH/RH Bolt; 1 ea. 1 1/4" Spanner Collar; 3 ea. Bushings; 6 ea. Plastic Washers; Specify Finish | 121.20 |
| KITRM1.5 | 11x1XHD | 2 ea. 3/8"-16 x 2 1/2" Thru Bolts; 2 ea. Finish Washers; 1 ea. 3/8"-16 x 3 1/2" LH/RH Bolt; 1 ea. 1 1/2" Spanner Collar; Specify Finish | 61.60 |
| KITRM380 | 11x12XHD | 2 ea. 3/8"-16 x 2 1/4" Decorative Thru Bolts 1 1/2" Dia.; 1 ea. 3/8"-16 x 3 1/2" LH/RH Bolt; 1 ea. 1 1/2" Spanner Collar; Specify Finish | 121.20 |
| KITRM380G | 14x15XHD | 2 ea. 3/8"-16 x 2 1/4" Decorative Thru Bolts 1 1/2" Dia.; 1 ea. 3/8"-16 x 3 1/2" LH/RH Bolt; 1 ea. 1 1/2" Spanner Collar; 3 ea. Bushings; 6 ea. Plastic Washers; Specify Finish | 139.40 |

ASSA ABLOY
Opening Solutions

The global leader in
door opening solutions

USA & Canada Prices Effective June 3, 2019

Copyright © 2019, ASSA ABLOY Accessories and Door Controls Group, Inc. All rights reserved. Reproduction in whole or in part without the express written permission of ASSA ABLOY Accessories and Door Controls Group, Inc. is prohibited.

Notes

ASSA ABLOY is the global leader in door opening solutions, dedicated to satisfying end-user needs for security, safety and convenience

ASSA ABLOY
Opening Solutions



300 Main Street
Rockwood, Pennsylvania 15557
P: 800-458-2424 • F: 800-922-9212
www.assaabloydooraccessories.us
orders.rockwood@assaabloy.com

(In Canada)
Door Security Solutions Canada
160 Four Valley Drive
Vaughan, ON L4K 4T9
P: 800-461-3007
www.assaabloydss.ca