



MARKSUSA

2022/2023

Price List

Mortise Locksets

**Cylindrical, Tubular & Electronic
Access Control Locksets**

Exit Devices



June 2022

Revision C 6/14/22

MORTISE LOCKSET PRICE LIST • EFFECTIVE SEPTEMBER 2016

TABLE OF CONTENTS

Required Information	7
Backset	7
Door Thickness	7
Handing	7
Mounts & Displays	7
Mortise Lock Trim Information	8
Leverset/Knobset Trim	8
How To Order Mortise Locksets & Handlesets	9-11
How To Order Instructions & Examples	10
1. Series	10
2. Plates/Roses/Handlesets	10
3. Knob/Lever	10
4. Mortise Functions	10
5. Finishes	10
6. Options	11
Plate Designs	12-23
Classic - CL	12-13
Capitol - CP	14-15
Crown - CR	16-17
Drake - DR	18-19
New Yorker - NY	20-21
Towne - TN	22-23
Rose Designs	22-23
Rose with Ring - RR	22-23
Plain Rose - RW	22-23
Small Rose with Ring - RQ	22-23
Small Rose - RS	22-23
Square Rose - RX	22-23
Square Rose - RK	22-23
Square Rose - RL	22-23
Ornamental Iron	24-24
Series 21 Unilock™	24
Series 22	24
Series 9215 Unilock™	24
Series 9225	24
THINLINE® Series 2750	24
Knob & Lever Kits	25
Accessories	25
Cylinders	25

MORTISE LOCKSET PRICE LIST

Mortise Parts & Trim	26-36
Mortise Lock Bodies Series 4 & 45	26
Mortise Lock Bodies Series 5 & 55	27
Mortise Lock Bodies Series 6 & 8	28
Mortise Lock Bodies Series 7 & 9	29
Mortise Deadlocks Series 31, 2, 3, 5 & 55	30
Mortise Lockset Functions	31-32
Mortise Lock Parts: Knob/Lever Rose Kits	33
Mortise Lock Parts: Dummy Cylinder, Collars & Turnpieces, Strikes, Spindles	34
Trim Lock Parts: Plate/Rose Design	35
Trim Lock Parts: Knob/Lever Design	36

CYLINDRICAL & TUBULAR LOCKSET PRICE LIST

How To Order Cylindrical Locksets	37
How To Order Example For Cylindrical Locksets	37
1. Series	37
2. Cylindrical Functions	37
3. Finishes	37
4. Options	37
Cylindrical Locksets	38-41
80 Line Grade 1 Cylindrical Knobsets	38
10 Line Grade 2 Cylindrical Knobsets	39
95 Line Grade 1 Cylindrical Survivor Series Leversets	40
75 Line Grade 2 Cylindrical Survivor Series Leversets	41
Cylindrical Lock Accessories	42
Latches, Strikes, Spacer Rings, Etc.	42
Cylinders, Cylindrical Lock Tailpieces, Cylindrical IC Core Tailpieces	43
How to order example for Cylindrical Lock Cylinders & Tailpieces	43
Cylindrical Knob/Lever Functions	44
How To Order Tubular Locksets	45
How To Order Example For Tubular Locksets	45
1. Series	45
2. Roses	45
3. Knob/Lever	45
4. Tubular Function	45
5. Finishes	45
6. Options	45
Tubular Knob & Lever Functions	45
Rose Designs	46
Rose with Ring - RR	46
Plain Rose - RW	46
Small Rose with Ring - RQ	46
Small Rose - RS	46
Square Rose - RX	46
Square Rose - RK	46
Square Rose - RL	46
Residential Interior Tubular Locksets	47
150 Series American Lever (<i>tubular leversets for interior use</i>)	47
250 Series Crescent Lever (<i>tubular leversets for interior use</i>)	47
450 Series Titan Lever (<i>tubular leversets for interior use</i>)	47
Tubular Lockset Accessories	48
Strikes, Latches, Support Housing	48
Turnpieces	48
Latches & Cylindrical Cartridge	48
How To Order For Defender Locksets	49
How To Order Example For Defender Locksets	49
1. Series	49
2. Tubular Functions	49
3. Finishes	49
Deadbolt/Deadlatch Functions	49

CYLINDRICAL & TUBULAR LOCKSET PRICE LIST

Defender Series Tubular Deadbolts & Cylindrical Cartridge Deadlatches	50
130 Series Grade 1 Defender Tubular Deadbolts	50
145 Series Grade 1 Defender Cylindrical Cartridge Deadlatches	50
Defender Series Accessories	51
Strikes, Latches & Spacers	51
Latches & Cylindrical Cartridge	51
Tailpieces & Cylinders	51
i-Qwik/i-Que Electronic Access Control Locksets	52-54
i-Qwik LITE ² Series Electronic Access Control & How To Order Example	52
i-Qwik/i-Que Series Options	53
i-Qwik/i-Que Series Accessories, Tailpieces & Cams	54
Request To EXit (REX) Leversets & Electrified Locksets	55-56
Request To EXit (REX) Cylindrical Grade 1 Leversets (EA195, EA295, EA395 & EA495)	55
How To Order Example For REX Leversets	55
195, 295, 395 & 495 Series Grade 1 Electrified Cylindrical Leversets	56
5 Series Grade 1 Electrified Mortise Lockset	56
Gate Locks	57
Swinging Gate Locks	57
Sliding Gate Locks	57
Parts	57
Custom Lockset Division	58-60
Series HA113 Housing Authority Mortise Lockset	58
Series LA318GJ Maximum Security Mortise Lockset	59
Series BE101 & LA118	60
Institutional Life Safety Mortise Locksets	61-65
Series 195BH D-Lig Slide Cylindrical Lockset	61
Series 5BH D-Lig Slide Mortise Lockset	62
Series 195SS Institutional Life Safety Cylindrical Lever Lockset	63
Series 5SS55 & 5SS19 Institutional Life Safety Mortise Knob & Lever Locksets	64
Series 180SS Institutional Life Safety Cylindrical Knobsets & Locksets	65
Series 31SS55 Institutional Life Safety Mortise Deadlock	65
Hospital Locksets	66
Series 180PD Cylindrical Push/Pull Paddlelocks	66
Series 5PD & 55PD Mortise Push/Pull Paddlelocks	66
Mortise Lock Cylinders, Parts & Cams	67
Cylinders, IC Core Cylinder Housings, Cylinder Cams	67
How To Order For Mortise Lock Cylinders	67
KEYS & KEYING	68
HI-SECURITY™ Cylinders	69-74
HI-SECURITY™ Cylinders: NON-UL	69
HI-SECURITY™ Cylinders: UL 437	70
Security-Mate™ Cylinders, Special Application Cylinders	71
How To Order HI-SECURITY™ Cylinders and Keys	72
Keys, Cams & Tailpieces	73
Parts List	74

PANIC DEVICES

Exit Devices	75-80
Series M9900 Exit Device - Rim Mount	75
Series M9900 VR Exit Device - Surface Vertical Rod	75
Series M9900 Exterior Trim	76
Series M8800 Exit Device	76
Series M195	77
Series M99 Night Latch Trim	77
Electric Latch Retraction with Simultaneous Dogging	78
Exit Alarm	78
Electric Dogging	79
Delayed Egress	70
M9900 LITE	80

ArchiTech™ SERIES NETWORK LOCKS

ArchiTech™ Series Network Locks	81-85
ArchiTech Series Features and Specifications	81
ArchiTech Series Cylindrical Locksets	82
How to Order ArchiTech Cylindrical Locksets	82
ArchiTech Series Mortise Locksets	83
How to Order ArchiTech Mortise Locksets	84
ArchiTech Series Network Options	85

Marks USA Antimicrobial Finish: Peace of mind for your hardware application when protected against GERMS and MOLD using Stericoat AM. Marks USA antimicrobial finish is recommended for hospitals, assisted living facilities, schools and childcare facilities. **Use Code - AM**

Lifetime Mechanical Limited Warranty: MARKS USA warrants that its products are free from defects in materials and workmanship. This warranty is limited to the lifetime of the door on which our lock is installed. In the event our product does not conform to this warranty, MARKS USA will repair or replace the product free of charge. This warranty does not cover defects or damage arising from improper installation, lack of or improper maintenance, improper storage, shipping and handling, ordinary wear and tear, misuse, abuse, accident, unauthorized service, or use with unauthorized non-MARKS products or parts. We reserve the right to make changes in materials, components or manufacturing methods. Liability under all warranties expressed or implied is limited to replacement of the defective goods. This warranty does not cover nor provide for the reimbursement or payment of incidental or consequential damages. Additionally, the company will not warrant ANSI A156.2 Grade 2 lever product installed in educational facilities and student housing.

2 Year Electronic Limited Warranty: MARKS USA warrants to the original purchaser that its products are free from defects in materials and workmanship so long as they occupy the premises.

In the event our product does not conform to this warranty, MARKS USA will repair or replace the product free of charge at its sole discretion. This warranty does not cover defects or damage arising from improper installation, lack of or improper maintenance, improper storage, shipping and handling, improper application or specification, ordinary wear and tear, misuse, abuse, accident, improper voltage, unauthorized service, or use with unauthorized non-MARKS products or parts. We reserve the right to make changes in materials, components or manufacturing methods. Liability under all warranties expressed or implied is limited to replacement of the defective goods. This warranty does not cover nor provide for the reimbursement or payment of incidental or consequential damages or any shipping charges related to exercising of this warranty.

Lifetime Finish Limited Warranty: MARKS USA Locksets with the "3E" finish will be warranted to the original user against tarnishing as long as the user occupies the residential premises upon which the lockset was originally installed. Locksets with this finish, used in commercial applications will be limited to two years. This warranty does not cover scratches, abrasion, abused or misused products. Upon return of a defective product to Marks USA, we will, at our sole discretion, either replace the product or refund the purchase price in exchange for the product.

Due to climatic conditions, chemical or abrasive actions, other finishes are excluded from this warranty. This warranty does not cover nor provide for the reimbursement or payment of incidental or consequential damages arising from the sale of the product.

TERMS & CONDITIONS:

TERMS: Net 30

FREIGHT: Prices are F.O.B. Amityville, New York. Freight allowed on shipments over \$7500 net invoice value within Continental U.S.

RETURNED GOODS: Goods may not be returned without a Returned Goods Authorization (RGA) and are subject to a restocking charge. RGA label must be on all cartons.

MINIMUM CHARGE: Orders for less than \$250 net invoice are subject to a \$25 handling charge.

MINIMUM SALES VOLUME: The company reserves the right to discontinue direct sales to any customer who does not meet the minimum annual sales requirements during any 12 month period. Minimum annual sales volume is determined on the basis of accepted orders during each applicable year. All orders are acknowledged. It is the customers responsibility to check accuracy of the acknowledgment when received.

ArchiTech, Network, iLock, LocDown, LifeSaver and Hi-Security are trademarks of Marks USA, a division of NAPCO Security Technologies. All other trademarks listed are properties of their respective companies.

Effective January 2022. All prices published are suggested list prices in US Dollars. Some specifications are preliminary and subject to change without prior notice. Not responsible for typographical errors.

Marks USA is a Division of Napco Security Technologies, Inc. (NASDAQ:NSSC) © Marks USA, 12.21

BACKSET - Required Information

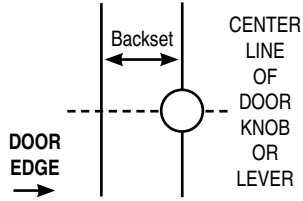

DOOR THICKNESS - Required Information

STANDARD DOOR THICKNESS RANGE:

- Mortise locksets: 1-3/4"
- Cylindrical locksets: 1-5/8" through 1-7/8"
- Ornamental locksets: 1" through 1-1/4"
- Tubular locksets: 1-3/8" through 1-3/4"
- Other door thickness: **Consult factory**

SPECIFY:

- Door thickness (A)
- Lock location (B)

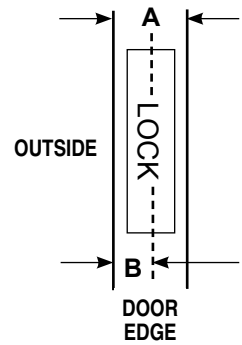

HANDING - Required Information

All locksets supplied 1/2 (LH) and 1/2 (RH) unless otherwise specified

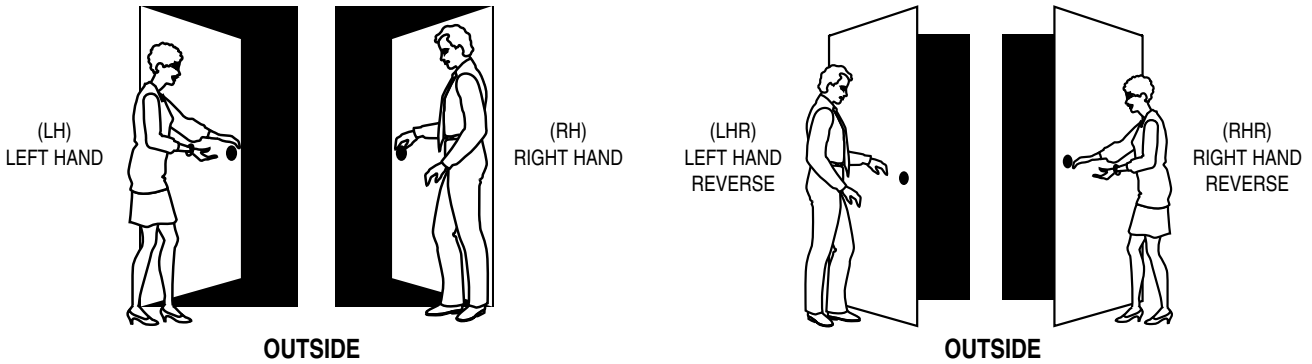

MOUNTS & DISPLAYS AVAILABLE, CONSULT FACTORY

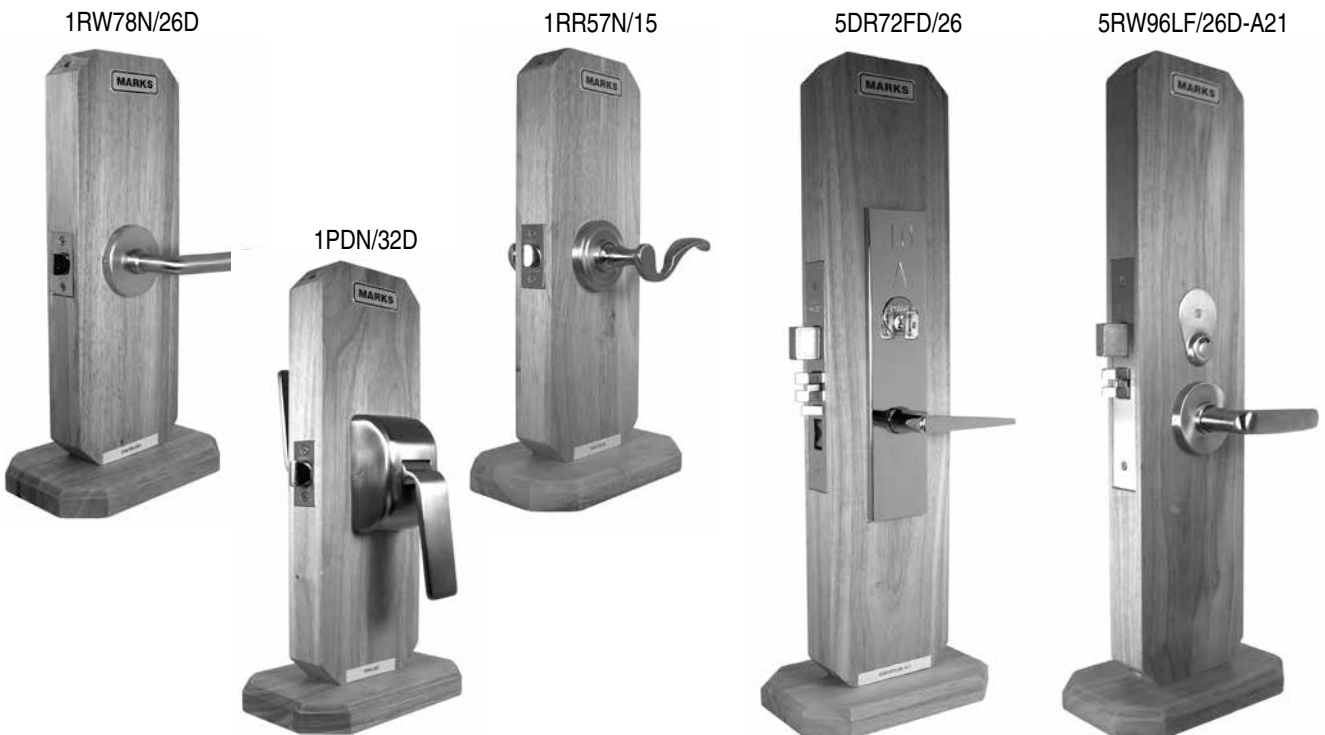

MORTISE LOCK TRIM INFORMATION

LEVERSET/KNOBSET TRIM

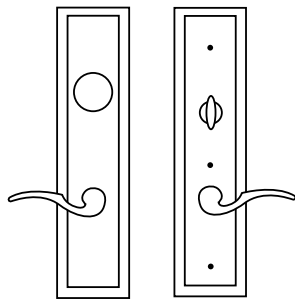

Outside Inside

ENTRANCE
Cylinder/Turnpiece

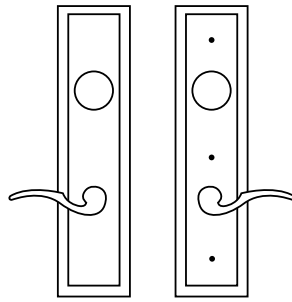

Outside Inside

ENTRANCE
Double Cylinder

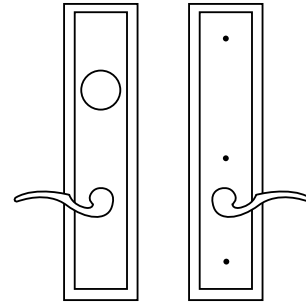

Outside Inside

OFFICE/CLASSROOM

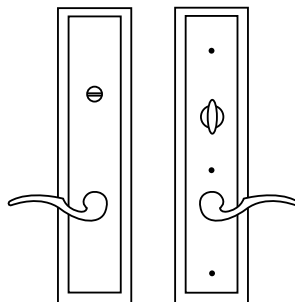

Outside Inside

PRIVACY

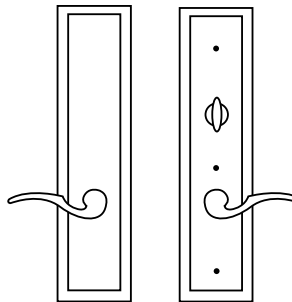

Outside Inside

EXTERIOR/PATIO

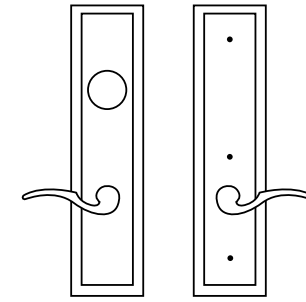

Outside Inside

DUMMY TRIM

Both sides

*Dummy cylinder optional (F17)

HOW TO ORDER MORTISE LOCKSETS & HANDLESETS

1. Select type of lockset.
2. See corresponding pages in the catalogues for information regarding this type of lock.
3. Create the part number for your lock by selecting the information from fields 1 through 6.
Please note dummy trim is Series "0".
4. Options must be listed in Alpha - Numeric order.
5. Note that if Part Number is over 15 characters, it becomes a special number with the option field *1.
(Your options will then be listed separately.)
Please note the standard (default) features of each lock - they do not need to be selected in the options section.
6. Please indicate keying detail or special instructions on each item ordered.
7. Door Templates are available on the website @ www.marksusa.com/support/templates

How To Order Example for Mortise Locksets	7	NY	10	A	/	3	—	G3
	1. Lock Series	2. Plate/Rose Design	3. Knob/Lever Design	4. Marks Function	Slash	5. Finish	Dash	6. Options

How To Order Example for Rose Design	5	RW	92	N	/	10B	—	D1
	1. Lock Series	2. Plate/Rose Design	3. Knob/Lever Design	4. Marks Function	Slash	5. Finish	Dash	6. Options

How To Order Example for Ornamental Iron	9215	AC	/	15	—	G3
	1. Series	2. Marks Function	Slash	3. Finish	Dash	4. Options

How To Order Example for Mortise Lock Bodies	55	JM	/	26D	—	T
	1. Series	2. Marks Function	Slash	3. Finish	Dash	4. Options

HOW TO ORDER MORTISE LOCKSETS & HANDLESETS

1 SERIES	
Dummy Trim	0
Dummy Trim Handlesets Only	00
Mortise Locks	4, 45, 5, 55, 6, 7, 8, 9
Mortise Deadlocks	31, 2, 3

2 PLATES/ROSES/HANDLESETS		
PLATES		DESIGN
Classic		CL
Capitol		CP
Crown		CR
Drake		DR
New Yorker		NY
School		LA
ROSES		DESIGN
9602-R	Rose with ring 2-9/16" dia.	RR
9602	Plain rose 2-9/16" dia.	RW
5602-R	Small rose with ring 2-1/4" dia.	RQ
5602	Small rose 2-1/4" dia.	RS
7602	Square rose 2-9/16"	RX
7607	Square forged rose 2-9/16"	RK

3 KNOB/LEVER		
KNOBS	DESIGN	
1153	Round, wrought	10
1253	Ball, wrought	20
9631	Ball, forged	30
9609	Eclipse, forged	60
LEVERS	DESIGN	
5642	Stanhope	44
5657	Brompton	55
5662	Monaco	57
5672	Towne	72
5677	Maxwell	77
5678	Omni	78
5682	Plaza	82
5683	Dayton	83
5686	Crescent	86
5692	American	92
5696	Titan	96

4 MORTISE FUNCTIONS		
MARKS FUNCTION:		
KEYED SINGLE CYLINDER,		
NO DEADBOLT		
		ANSI #
D	OFFICE/VEST.	
DW	VESTIBULE	
E	OFFICE	F04
EW	STOREROOM	F07
EX	EXIT	F31
J	CLASSROOM	F05
JM	HOSPITAL	F06
JR	HOSPITAL	F06
GL	INST PRIVACY	F26
EN	STOREROOM	
DN	STOREROOM	
EL	ELECTRICALLY LOCKED	
EU	ELECTRICALLY UNLOCKED	
KEYED SINGLE CYLINDER,		
WITH DEADBOLT		
		ANSI #
A	ENTRANCE	F08,
F10		
B	ENTRANCE	F21
F	DORMITORY	F12
FS	DORMITORY	
FW	DORMITORY	F13
FD	APARTMENT	F20
H	HOTEL	F15
LH	SPECIAL PRIVACY	
KEYED DOUBLE CYLINDER,		
NO DEADBOLT		
		ANSI #
G	ENTRANCE	F09
GC	INTRUDER LATCHBOLT	F32
GG	CLASSROOM SECURITY	
GR	CLASSROOM SECURITY w/	
	HOLDBACK	
WW	INSTITUTION	F30
KEYED DOUBLE CYLINDER,		
WITH DEADBOLT		
		ANSI #
AC	ENTRANCE	F35
C	STOREROOM	F14
FC	INTRUDER DEADBOLT	F34
FA	DORMITORY	F11
FX	DORMITORY	F33
SO	STOREROOM	F25
KEYLESS		
		ANSI #
N	PASSAGE	F01
L	BATHROOM	F02
LF	PRIVACY	F19
LJ	PRIVACY	F22
DUMMY TRIM		
		ANSI #
DI	DUMMY TRIM INSIDE	
DO	DUMMY TRIM OUTSIDE	
DT	FULL DUMMY TRIM	

5 FINISH		
MARKS		ANSI #
US 3	Polished Brass, Clear Coated	605
US 3E	Polished Brass "PVD"	605E
US 4	Satin Brass, Clear Coated	606, 606E
US 5	Antique Brass, Clear Coated	609, 609E
US 10E	Satin Bronze "PVD"	612E
US 10	Satin Bronze, Clear Coated	612
US 10B	Dark Bronze, Clear Coated	613E
US 14	Bright Nickel Plating, Clear Coated	614
US 15	Satin Nickel	619, 619E
US 19	Flat Black, Powder Coated	622, 622E
US 20A	Dark Oxidized Statuary Bronze, Clear Coated	624
US 26	Polished Chrome, Plated	625
US 26D	Satin Chrome, Plated	626
US 26E	Satin Chrome, Powder Coat	626E
US 32	Polished Stainless Steel	629
US 32D	Satin Stainless Steel	630
AM	Antimicrobial Finish	AM, +40



FINISH DESIGNATIONS	
Split Finish Designation	
Marks USA Antimicrobial finish - Code: AM	
Split Finish: Exterior one finish/interior one finish	
designate by an "X"	
Ex: 4TN57A/3Ex15-F3	
Exterior trim 3E Interior Trim US 15	
Combination Finish Designation	
Combination Finish:	
Alternating different finishes on same side of trim designate by	
a "/" between finishes	
Ex: 4TN57A/3E/15-F3	
Exterior and Interior trim 3E	
US 15 cylinder, turnpiece & lever.	

How To ORDER MORTISE LOCKSETS & HANDLESETS

6			OPTIONS					
LOCK FRONT	CODE	PRICE	DOOR THICKNESS	CODE	PRICE	ELECTRIFIED	CODE	PRICE
1-1/16" x 8"	Q	28	50 mm (2")	D1	NC	24V	H1	
1-1/16" x 5-5/8"	R	29	57 mm (2-1/4")	D2	45	12V	H2	
1-1/16" x 7-5/8"	T	29	1-3/4"	D4	NC	Electrically locked	H9	
1-1/4" x 10"	U	112	1-3/8"	D5	NC	Electrically unlocked	H10	
1-1/16" x 7-3/4"	V	28	1" - 1-1/4"	D6	NC	STRIKE	CODE	PRICE
1" x 7-1/8"	W	NC	2" - 2-1/4"	D7	45	4-7/8" ASA strike	S1	14
1-1/4" x 8"	X	26	1-1/4" - 1-1/2"	D8	NC	Straight lip strike	S2	4
1-1/4" x 8-5/8"	Y	112	Over 3"	D9	667	2-3/4" "T" strike	S3	NC
1" x 8"	Z	26	2-3/4"-3"	D14	309	3-5/8" x 1-1/4" Security strike	S4	12
TRIM MODIFICATIONS	CODE	PRICE	LATCH	CODE	PRICE	2-1/4" Curved lip strike	S5	NC
Tactile knob/lever, coated ext. only	A1	62	Solid latch	E1	21	4-7/8" Strikes: 1 Left / 1 Right	S6	14
Emergency coinkey	A2	29	Hold open latch	E2	38	Strike with 1-1/2" lip	S7	17
Tamper-proof screws	A3	15	Auxiliary latch	E3	36	Radius corner strike	S8	NC
Tactile knob/lever, knurled	A4	62	2-3/4" backset, 1-1/8" x 2-1/4" face	E4	11	4035-1 strike	S9	NC
Hotel indicator	A6	45	2-3/8" backset, 1" x 2-1/4" face	E6	NC	ELECTRONICS	CODE	PRICE
Pinned knob	A7	36	TRIM CHANGES	CODE	PRICE	Sensor array package: REX & key switch	W1	330
Mushroom knob	A9	6	Lead lined	F1	335	Hard wired	W5	27
Engraved	A11	73	Large inside plate	F2	36	Request to exit switch	W10	140
Concealed cylinder	A12	28	Less inside trim**	F4	NC	Key sensor	W11	165
Dummy trim sub-assembly	A13	—	Less outside trim**	F5	NC	Titan lever	W12	20
Coinkey w/ escutcheon plate	A14	72	For 1-1/2" bore	F6	21	Request to EXit switch, key sensor		
Coinkey w/ rose	A15	72	Adjustable spring collars	F10	6	& bolt sensor	W13	494
Occupancy Indicator	A17	93	Corbin 6 pin IC core	F12	33	(W13 option for mortise locksets)		
Tactile knob/lever, coated int. & ext.	A18	126	Corbin 7 pin IC core	F13	35	Bolt sensor	W14	165
BE 1-1/2" thick door adapter plate	A19	80	Yale 6 pin IC core	F14	24	Latch sensor	W15	165
Crescent Lever	A22	NC	Yale 7 pin IC core	F15	24	REX + Latch sensor	W16	330
Square trim	A23	30	Less outside knob/lever	F16		MISC	CODE	PRICE
- Square collar	A23C	+11	Less outside trim w/ custom			Please read special comments	#	
- Square turnpiece	A23T	+11	escutcheon**	F18	NC	regarding line item.		
Small emergency hole	A24	NC	Schlage 6 pin IC core	F19	24			
SS55 Knob on EXT or INT (specify)	A25	43	Sargent IC core	F20	24			
Plaza Lever	A26	NC	Medeco IC core large format	F21	24			
Recessed Pull (one side)	A28	73	IQ lead lined	F22	428			
Exposed Rose Screws	A29	NC	ASSA IC Core	F24	22			
Engraved and Filled	A30	83	Blank Inside Plate/Lever	F25	NC			
Inside Knob on Lever	A31	36	Blank Outside Plate/Lever	F26	NC			
No inside turnpiece	A32	NC	Yale 6 pin IC core w/ captivated tail	F27	NC			
LOCK BODY <i>Red, Green, BCC, Ind.</i>	CODE	PRICE	Yale 7 pin IC core w/ captivated tail	F28	NC			
Lever override guard - outside*	B1	45	Screwless Inside Escutcheon	F29	31			
Lever override guard - both sides*	B2	64	CYLINDER	CODE	PRICE			
Hardened pins - deadbolt	B3	19	IC core housing - 7 Pin	G1	NC			
Lever springs	B4	20	Special optional keyway	G2	38			
Pin and lever springs	B5	38	Less cylinder	G3	Deduct 16			
Hollow spacer	B6	19	MARKS "C" keyway	G5	17			
8 mm hubs on square	B7	19	IC core housing w/9271 Collar - 6 Pin	G6	NC			
Turnpiece hub on square	B8	12	IC core housing, Schlage large format					
With deadbolt	B9	19	(FOR MORTISE ONLY)	G7	82			
Boxed Lock Body	B10	NC						
Lever spring outside only	B11	NC						
Lever spring inside only	B12	NC						

* Not available in CP plate design.
** Consult factory before ordering.

CLASSIC PLATE DESIGN CL

	ANSI-A156.13 • Grade 1 3 Hour Fire Rating		Series 5 • 2-3/4" Backset Series 55 • 2-1/2" Backset	
	Standard Features		KNOBS	LEVERS
	<ul style="list-style-type: none"> • Thru-bolted screwless knob/lever plate assemblies • Independent spring loaded captivated spindles • Reversible mortise lock 2-1/2" or 2-3/4" backset • Lever support springs • Lock front: 1-1/4" x 8" • Dimensions: Ext: 8" H x 2-1/2" W, Int: 8" H x 2-1/2" W • Cylinder: MARKS "C" keyway, 6 pin w/ 2 keys • Height: 7/32" 	10, 20	031, 44, 55, 57, 72, 77, 78, 82, 83, 86, 92, 96	
MARKS #	FUNCTION	ANSI #	32D	32D
KEYED SINGLE CYLINDER, NO DEADBOLT				
D	OFFICE VEST.		675.57	834.02
DW	VESTIBULE			
E	OFFICE	F04		
EW	STOREROOM	F07		
J	CLASSROOM	F05		
JM, JR	HOSPITAL	F06	1024.59	1181.97
GL	INSTIT. PRIVACY	F26		
EL	ELECTRICALLY LOCKED			
EU	ELECTRICALLY UNLOCKED			
KEYED SINGLE CYLINDER, WITH DEADBOLT				
A	ENTRANCE	F08, F10	690.56	849.01
B	ENTRANCE	F21		
F	DORMITORY	F12		
FS	DORMITORY			
FW	DORMITORY	F13		
FD	APARTMENT	F20	759.08	916.46
H	HOTEL	F15		
LH	SPECIAL PRIVACY			
KEYED DOUBLE CYLINDER, NO DEADBOLT				
G	APARTMENT	F09	728.03	885.41
GC	INTRUDER LATCHBOLT	F32		
GG	CLASSROOM SECURITY			
GR	CLASSROOM SECURITY w/HOLDBACK			
WW	INSTITUTIONAL	F30		
KEYED DOUBLE CYLINDER, WITH DEADBOLT				
AC	ENTRANCE	F35	728.03	885.41
C	STOREROOM	F14		
FC	INTRUDER DEADBOLT	F34		
FA	DORMITORY	F11		
FX	DORMITORY	F33		
KEYLESS				
N	PASSAGE	F01	562.43	725.89
L	BATHROOM	F02	692.70	850.08
LF	PRIVACY	F19		
LJ	PRIVACY	F22	625.25	782.63
EX	EXIT	F31	625.25	782.63
DUMMY TRIM				
DI	DUMMY TRIM INSIDE		285.86	364.01
DO	DUMMY TRIM OUTSIDE			
DT	FULLY DUMMY		568.50	726.96

KNOB & LEVERS ARE PACKED 6 PER CASE

NOTE: Split designs and/or finishes are priced at the highest design and/or finish • Special finishes, consult factory

CLASSIC PLATE DESIGN CL



	ANSI-A156.13 • Grade 2		Series 7 • 2-3/4" Backset Series 9 • 2-1/2" Backset	
	Standard Features		KNOBS	LEVERS
	<ul style="list-style-type: none"> • Thru-bolted screwless knob/lever plate assemblies • Independent spring loaded captivated spindles • Reversible mortise lock 2-1/2" or 2-3/4" backset • Lever support springs • Lock front Series 7: 1-1/4" x 8", Series 9: 1-1/16" x 7-5/8" • Dimensions: Ext: 8" H x 2-1/2" W, Int: 8" H x 2-1/2" W • Cylinder: MARKS "C" keyway, 6 pin w/ 2 keys 		10, 20	031, 44, 55, 57, 72, 77, 78, 82, 83, 86, 92, 96
FINISH GROUPS				
MARKS #	FUNCTION	ANSI #	32D	32D
KEYED SINGLE CYLINDER, NO DEADBOLT				
D	OFFICE VEST.		640.24	798.69
DW	VESTIBULE			
KEYED SINGLE CYLINDER, WITH DEADBOLT				
A	ENTRANCE	F08, F10	656.30	813.68
B	ENTRANCE	F21		
F	DORMITORY	F12		
FS	DORMITORY			
FW	DORMITORY	F13		
KEYED DOUBLE CYLINDER, WITH DEADBOLT				
AC	ENTRANCE	F35	693.77	851.15
C	STOREROOM	F14		
FX	DORMITORY	F33		
KEYLESS				
N	PASSAGE	F01	532.10	690.56
L	BATHROOM	F02	657.37	814.75
LF	PRIVACY	F19		
DUMMY TRIM				
DI	DUMMY TRIM INSIDE		285.86	364.01
DO	DUMMY TRIM OUTSIDE			
DT	FULLY DUMMY		568.50	726.96

KNOBS & LEVERS ARE PACKED 6 PER CASE

NOTE: Split designs and/or finishes are priced at the highest design and/or finish • Special finishes, consult factory

KNOBS	Round Knob 10	Ball Knob 20		
				
LEVERS	Stanhope Lever 44	Copa Lever 031	Brompton Lever 55	Monaco Lever 57 Specify handing
				
	Towne Lever 72	Maxwell Lever 77	Omni Lever 78	Plaza Lever 82 Specify handing
				
	Dayton Lever 83 Specify handing	Crescent Lever 86	American Lever 92	Titan Lever 96
				

CAPITOL PLATE DESIGN CP



	ANSI-A156.13 • Grade 1 3 Hour Fire Rating			Series 5 • 2-3/4" Backset Series 55 • 2-1/2" Backset		
	Standard Features		KNOBS		LEVERS	
	<ul style="list-style-type: none"> • Thru-bolted screwless knob/lever plate assemblies • Independent spring loaded captivated spindles • Reversible mortise lock 2-1/2" or 2-3/4" backset • Lever support springs • Lock front: 1-1/4" x 8" • Dimensions: Ext: 8-1/2" H x 2-3/4" W, Int: 8-1/2" H x 2-3/4" W • Cylinder: MARKS "C" keyway, 6 pin w/ 2 keys • Concealed 5 pin cylinder (option A12) • Thickness: 1/8" 		10, 20		031, 44, 55, 57, 72, 77, 78, 82, 83, 86, 92, 96	031, 82, 83, 86, 92, 96
FINISH GROUPS						
MARKS #	FUNCTION	ANSI #	3, 32D	10, 10B	3, 32D	10, 10B
KEYED SINGLE CYLINDER, NO DEADBOLT						
D	OFFICE VEST.		703.40	744.09	860.79	905.75
DW	VESTIBULE					
E	OFFICE	F04				
EW	STOREROOM	F07				
J	CLASSROOM	F05				
JM, JR	HOSPITAL	F06				
GL	INSTIT. PRIVACY	F26				
EL	ELECTRICALLY LOCKED		1052.43	1093.11	1209.81	1250.50
EU	ELECTRICALLY UNLOCKED					
KEYED SINGLE CYLINDER, WITH DEADBOLT						
A	ENTRANCE	F08, F10	718.39	760.15	876.85	917.53
B	ENTRANCE	F21				
F	DORMITORY	F12				
FS	DORMITORY					
FW	DORMITORY	F13				
FD	APARTMENT	F20	785.84	826.53	944.30	986.05
H	HOTEL	F15				
LH	SPECIAL PRIVACY					
KEYED DOUBLE CYLINDER, NO DEADBOLT						
G	APARTMENT	F09	756.93	797.62	914.32	955.00
GC	INTRUDER LATCHBOLT	F32				
GG	CLASSROOM SECURITY					
GR	CLASSROOM SECURITY w/HOLDBACK					
WW	INSTITUTIONAL	F30				
KEYED DOUBLE CYLINDER, WITH DEADBOLT						
AC	ENTRANCE	F35	756.93	797.62	914.32	955.00
C	STOREROOM	F14				
FC	INTRUDER DEADBOLT	F34				
FA	DORMITORY	F11				
FX	DORMITORY	F33				
KEYLESS						
N	PASSAGE	F01	596.34	637.02	754.79	795.98
L	BATHROOM	F02	720.53	761.22	877.92	918.60
LF	PRIVACY	F19				
LJ	PRIVACY	F22	654.15	694.84	811.54	852.22
EX	EXIT	F31	654.15	694.84	811.54	852.22
DUMMY TRIM						
DI	DUMMY TRIM INSIDE		293.63	319.05	376.86	398.27
DO	DUMMY TRIM OUTSIDE					
DT	FULLY DUMMY		596.34	638.10	755.86	796.55

KNOB & LEVERS ARE PACKED 6 PER CASE



NOTE: Split designs and/or finishes are priced at the highest design and/or finish • Special finishes, consult factory

CAPITOL PLATE DESIGN CP

	ANSI-A156.13 • Grade 2		Series 7 • 2-3/4" Backset Series 9 • 2-1/2" Backset				
	Standard Features		KNOBS		LEVERS		
	<ul style="list-style-type: none"> • Thru-bolted screwless knob/lever plate assemblies • Independent spring loaded captivated spindles • Reversible mortise lock 2-1/2" or 2-3/4" backset • Lever support springs • Lock front Series 7: 1-1/4" x 8", Series 9: 1-1/16" x 7-5/8" • Dimensions: Ext: 8-1/2" H x 2-3/4" W, Int: 8-1/2" H x 2-3/4" W • Cylinder: MARKS "C" keyway, 6 pin w/ 2 keys • Concealed 5 pin cylinder (option A12) 		10, 20		031, 44, 55, 57, 72, 77, 78, 82, 83, 86, 92, 96		
				FINISH GROUPS			
MARKS #	FUNCTION	ANSI #	3, 32D	10,10B	3, 32D	10, 10B	
KEYED SINGLE CYLINDER, NO DEADBOLT							
D	OFFICE VEST.		668.07	708.76	825.46	868.28	
DW	VESTIBULE						
KEYED SINGLE CYLINDER, WITH DEADBOLT							
A	ENTRANCE	F08, F10	684.13	724.82	841.51	882.20	
B	ENTRANCE	F21					
F	DORMITORY	F12					
FS	DORMITORY						
FW	DORMITORY	F13					
KEYED DOUBLE CYLINDER, WITH DEADBOLT							
AC	ENTRANCE	F35	721.60	762.29	878.99	919.67	
C	STOREROOM	F14					
FX	DORMITORY	F33					
KEYLESS							
N	PASSAGE	F01	561.01	601.69	719.46	760.15	
L	BATHROOM	F02	685.20	725.89	842.59	883.27	
LF	PRIVACY	F19					
DUMMY TRIM							
DI	DUMMY TRIM INSIDE		297.63	319.05	376.86	398.27	
DO	DUMMY TRIM OUTSIDE						
DT	FULLY DUMMY		596.34	638.10	755.86	796.55	
NOTE: Split designs and/or finishes are priced at the highest design and/or finish • Special finishes, consult factory							

KNOBS	Round Knob 10	Ball Knob 20				
						
LEVERS	Stanhope Lever 44	Copa Lever 031	Brompton Lever 55	Monaco Lever 57 Specify handing		
						
	Towne Lever 72	Maxwell Lever 77	Omni Lever 78	Plaza Lever 82 Specify handing		
						
	Dayton Lever 83 Specify handing	Crescent Lever 86	American Lever 92	Titan Lever 96		
						

CROWN PLATE DESIGN CR

BHMA CERTIFIED		ANSI-A156.13 • Grade 1 3 Hour Fire Rating		c  US LISTED		Series 5 • 2-3/4" Backset Series 55 • 2-1/2" Backset				
	Standard Features			KNOBS			LEVERS			
	<ul style="list-style-type: none"> • Thru-bolted screwless knob/lever plate assemblies • Independent spring loaded captivated spindles • Reversible mortise lock 2-1/2" or 2-3/4" backset • Lever support springs • Lock front: 1-1/4" x 8" • Dimensions: Ext: 8-1/2" H x 2" W, Int: 8-1/2" H x 2" W • Cylinder: MARKS "C" keyway, 6 pin w/ 2 keys • Concealed 5 pin cylinder (option A12) • Height: 13/32" • Square Edges 			10, 20		30, 60		031, 44, 55, 57, 72, 77, 78, 82, 83, 86, 92, 96		031, 82, 83, 86, 92, 96
				FINISH GROUPS						
MARKS #	FUNCTION	ANSI #	3, 26D, 32D	10, 10B, 32	3E, 15, 26D	10, 10B, 14	3E, 15, 26D	10, 10B, 14, 19, 26	32, 32D	
KEYED SINGLE CYLINDER, NO DEADBOLT										
D	OFFICE VEST.									
DW	VESTIBULE									
E	OFFICE	F04								
EW	STOREROOM	F07	726.96	767.64	771.92	812.61	837.23	918.60	877.92	
J	CLASSROOM	F05								
JM, JR	HOSPITAL	F06								
GL	INSTIT. PRIVACY	F26								
EL	ELECTRICALLY LOCKED									
EU	ELECTRICALLY UNLOCKED		1074.91	1116.67	1118.81	1144.50	1169.13	1250.50	1209.81	
KEYED SINGLE CYLINDER, WITH DEADBOLT										
A	ENTRANCE	F08, F10								
B	ENTRANCE	F21								
F	DORMITORY	F12	741.95	782.63	785.84	826.53	852.22	933.59	892.90	
FS	DORMITORY									
FW	DORMITORY	F13								
FD	APARTMENT	F20								
H	HOTEL	F15	765.50	806.18	810.47	851.15	875.77	957.14	916.46	
LH	SPECIAL PRIVACY									
KEYED DOUBLE CYLINDER, NO DEADBOLT										
G	APARTMENT	F09								
GC	INTRUDER LATCHBOLT	F32								
GG	CLASSROOM SECURITY		775.14	815.82	819.03	859.72	884.34	966.78	926.09	
GR	CLASSROOM SECURITY w/HOLDBACK									
WW	INSTITUTIONAL	F30								
KEYED DOUBLE CYLINDER, WITH DEADBOLT										
AC	ENTRANCE	F35								
C	STOREROOM	F14								
FC	INTRUDER DEADBOLT	F34	775.14	815.82	819.03	859.72	884.34	966.78	926.09	
FA	DORMITORY	F11								
FX	DORMITORY	F33								
KEYLESS										
N	PASSAGE	F01	624.18	664.86	669.14	708.76	734.45	815.82	775.14	
L	BATHROOM	F02	741.95	782.63	785.84	826.53	852.22	933.59	892.90	
LF	PRIVACY	F19								
LJ	PRIVACY	F22	678.78	720.53	723.75	764.43	789.05	871.49	830.81	
EX	EXIT	F31								
DUMMY TRIM										
DI	DUMMY TRIM INSIDE		311.55	335.11	337.25	357.59	370.44	431.46	390.78	
DO	DUMMY TRIM OUTSIDE									
DT	FULLY DUMMY		629.53	670.21	674.50	715.18	739.80	821.17	780.49	

KNOBS & LEVERS ARE PACKED 6 PER CASE



NOTE: Split designs and/or finishes are priced at the highest design and/or finish • Special finishes, consult factory

CROWN PLATE DESIGN CR

	ANSI-A156.13 • Grade 2		Series 7 • 2-3/4" Backset Series 9 • 2-1/2" Backset						
	Standard Features		KNOBS			LEVERS			
	<ul style="list-style-type: none"> • Thru-bolted screwless knob/lever plate • Independent spring loaded captivated spindles • Reversible mortise lock 2-1/2" or 2-3/4" backset • Lever support springs • Lock front Series 7: 1-1/4" x 8", Series 9: 1-1/16" x 7-5/8" • Dimensions: Ext: 8-1/2" H x 2" W, Int: 8-1/2" H x 2" W • Cylinder: MARKS "C" keyway, 6 pin w/ 2 keys • Concealed 5 pin cylinder (option A12) 		10, 20	30, 60	031, 44, 55, 57, 72, 77, 78, 82, 83, 86, 92, 96	031, 82, 83, 86, 92, 96			
MARKS #	FUNCTION	ANSI #	FINISH GROUPS						
			3, 26D, 32D	10, 10B, 32	3E, 15, 26D	10, 10B, 14, 26	3E, 15	10, 10B, 14, 19E	32, 32D
KEYED SINGLE CYLINDER, NO DEADBOLT									
D	OFFICE VEST.		692.70	733.38	736.59	777.28	801.90	883.27	842.59
DW	VESTIBULE								
KEYED SINGLE CYLINDER, WITH DEADBOLT									
A	ENTRANCE	F08, F10	706.62	747.30	751.58	792.27	816.89	898.26	857.57
B	ENTRANCE	F21							
F	DORMITORY	F12							
FS	DORMITORY								
KEYED DOUBLE CYLINDER, WITH DEADBOLT									
AC	ENTRANCE	F35	739.80	780.49	783.70	824.38	850.08	931.45	890.76
C	STOREROOM	F14							
FX	DORMITORY	F33							
KEYLESS									
N	PASSAGE	F01	588.85	629.53	633.81	674.50	699.12	780.49	739.80
L	BATHROOM	F02	706.62	747.30	751.58	793.34	816.89	898.26	857.57
LF	PRIVACY	F19							
DUMMY TRIM									
DI	DUMMY TRIM INSIDE		311.55	335.11	337.25	357.59	370.44	431.46	390.78
DO	DUMMY TRIM OUTSIDE								
DT	FULLY DUMMY								
NOTE: Split designs and/or finishes are priced at the highest design and/or finish • Special finishes, consult factory									

KNOBS	Round Knob 10	Ball Knob 20	Ball Knob 30	Eclipse Knob 60
				
LEVERS	Stanhope Lever 44	Copa Lever 031	Brompton Lever 55	Monaco Lever 57 Specify handing
				
	Towne Lever 72	Maxwell Lever 77	Omni Lever 78	Plaza Lever 82 Specify handing
				
Dayton Lever 83 Specify handing	Crescent Lever 86	American Lever 92	Titan Lever 96	
				

DRAKE PLATE DESIGN DR

		ANSI-A156.13 • Grade 1 3 Hour Fire Rating			Series 5 • 2-3/4" Backset Series 55 • 2-1/2" Backset				
	Standard Features		KNOBS			LEVERS			
	<ul style="list-style-type: none"> • Thru-bolted screwless knob/lever plate • Independent spring loaded captivated spindles • Reversible mortise lock 2-1/2" or 2-3/4" backset • Lever support springs • Lock front: 1-1/4" x 8" • Dimensions: Ext: 11" H x 2-1/2" W, Int: 11" H x 2-1/2" W • Cylinder: MARKS "C" keyway, 6 pin w/ 2 keys • Concealed 5 pin cylinder (option A12) • Height: 13/32" • Square Edges 		10, 20	30, 60	031, 44, 55, 57, 72, 77, 78, 82, 83, 86, 92, 96		031, 82, 83, 86, 92, 96		
FINISH GROUPS									
MARKS #	FUNCTION	ANSI #	3, 26D, 32D	10, 10B, 32	3E, 15, 26D	10, 10B, 14	3E, 15, 26D	10E, 10B, 14, 19E, 26	32, 32D
KEYED SINGLE CYLINDER, NO DEADBOLT									
D	OFFICE VEST.		802.97	843.66	847.94	888.62	913.25	994.61	953.93
DW	VESTIBULE								
E	OFFICE	F04							
EW	STOREROOM	F07							
J	CLASSROOM	F05							
JM, JR	HOSPITAL	F06							
GL	INSTIT. PRIVACY	F26							
EL	ELECTRICALLY LOCKED		1150.93	1191.61	1195.89	1219.45	1245.14	1326.51	1285.83
EU	ELECTRICALLY UNLOCKED								
KEYED SINGLE CYLINDER, WITH DEADBOLT									
A	ENTRANCE	F08, F10	817.96	858.64	861.86	903.61	928.24	1009.60	968.92
B	ENTRANCE	F21							
F	DORMITORY	F12							
FS	DORMITORY								
FW	DORMITORY	F13							
FD	APARTMENT	F20							
H	HOTEL	F15	841.51	882.20	885.41	927.17	950.72	1033.16	992.47
LH	SPECIAL PRIVACY								
KEYED DOUBLE CYLINDER, NO DEADBOLT									
G	APARTMENT	F09	851.15	891,83	895.05	935.73	960.35	1042.79	1001.04
GC	INTRUDER LATCHBOLT	F32							
GG	CLASSROOM SECURITY								
GR	CLASSROOM SECURITY w/HOLDBACK								
WW	INSTITUTIONAL	F30							
KEYED DOUBLE CYLINDER, WITH DEADBOLT									
AC	ENTRANCE	F35	851.15	891,83	895.05	935.73	960.35	1042.79	1001.04
C	STOREROOM	F14							
FC	INTRUDER DEADBOLT	F34							
FA	DORMITORY	F11							
FX	DORMITORY	F33							
KEYLESS									
N	PASSAGE	F01	700.19	740.88	744.09	784.77	810.47	891.83	851.15
L	BATHROOM	F02	817.96	858.64	861.86	903.61	928.24	1009.60	968.92
LF	PRIVACY	F19							
LJ	PRIVACY	F22	755.86	796.55	799.76	840.44	865.07	947.51	906.82
EX	EXIT	F31							
DUMMY TRIM									
DI	DUMMY TRIM INSIDE		353.31	373.65	374.72	396.13	407.91	470.01	429.32
DO	DUMMY TRIM OUTSIDE								
DT	FULLY DUMMY		705.54	746.23	749.44	792.27	815.82	897.19	856.50

KNOBS & LEVERS ARE PACKED 6 PER CASE



NOTE: Split designs and/or finishes are priced at the highest design and/or finish • Special finishes, consult factory

DRAKE PLATE DESIGN DR

	ANSI-A156.13 • Grade 2		Series 7 • 2-3/4" Backset Series 9 • 2-1/2" Backset																																																																																																																																		
	Standard Features		KNOBS			LEVERS																																																																																																																															
	<ul style="list-style-type: none"> • Thru-bolted screwless knob/lever plate • Independent spring loaded captivated spindles • Reversible mortise lock 2-1/2" or 2-3/4" backset • Lever support springs • Lock front Series 7: 1-1/4" x 8", Series 9: 1-1/16" x 7-5/8" • Dimensions: Ext: 11" H x 2-1/2" W, Int: 11" H x 2-1/2" W • Cylinder: MARKS "C" keyway, 6 pin w/ 2 keys • Concealed 5 pin cylinder (option A12) 		10, 20	30, 60	031, 44, 55, 57, 72, 77, 78, 82, 83, 86, 92, 96		031, 82, 83, 86, 92, 96																																																																																																																														
MARKS #	FUNCTION	ANSI #	FINISH GROUPS																																																																																																																																		
			3, 26D, 32D	10, 10B, 32	3E, 15, 26D	10, 10B, 14	3E, 15, 26D	10E, 10B, 14, 19E, 26, 32	32D																																																																																																																												
KEYED SINGLE CYLINDER, NO DEADBOLT																																																																																																																																					
D	OFFICE VEST.		769.78	809.40	812.61	853.29	877.92	959.28	918.60																																																																																																																												
DW	VESTIBULE									KEYED SINGLE CYLINDER, WITH DEADBOLT										A	ENTRANCE	F08, F10	782.63	823.31	826.53	869.35	892.90	975.34	933.59	B	ENTRANCE	F21	F	DORMITORY	F12	FS	DORMITORY		KEYED DOUBLE CYLINDER, WITH DEADBOLT										AC	ENTRANCE	F35	815.82	856.50	859.72	901.47	926.09	1007.46	966.78	C	STOREROOM	F14	FX	DORMITORY	F33	KEYLESS										N	PASSAGE	F01	664.86	705.54	708.76	750.51	775.14	856.50	815.82	L	BATHROOM	F02	782.63	823.31	826.53	869.35	892.90	975.34	933.59	LF	PRIVACY	F19	DUMMY TRIM										DI	DUMMY TRIM INSIDE		353.31	373.65	374.72	396.13	407.91	470.01	429.32	DO	DUMMY TRIM OUTSIDE		DT	FULLY DUMMY		705.54	735.52	750.51	792.27	815.82	897.19	856.50	NOTE: Split designs and/or finishes are priced at the highest design and/or finish • Special finishes, consult factory		
KEYED SINGLE CYLINDER, WITH DEADBOLT																																																																																																																																					
A	ENTRANCE	F08, F10	782.63	823.31	826.53	869.35	892.90	975.34	933.59																																																																																																																												
B	ENTRANCE	F21																																																																																																																																			
F	DORMITORY	F12																																																																																																																																			
FS	DORMITORY																																																																																																																																				
KEYED DOUBLE CYLINDER, WITH DEADBOLT																																																																																																																																					
AC	ENTRANCE	F35	815.82	856.50	859.72	901.47	926.09	1007.46	966.78																																																																																																																												
C	STOREROOM	F14																																																																																																																																			
FX	DORMITORY	F33																																																																																																																																			
KEYLESS																																																																																																																																					
N	PASSAGE	F01	664.86	705.54	708.76	750.51	775.14	856.50	815.82																																																																																																																												
L	BATHROOM	F02	782.63	823.31	826.53	869.35	892.90	975.34	933.59																																																																																																																												
LF	PRIVACY	F19																																																																																																																																			
DUMMY TRIM																																																																																																																																					
DI	DUMMY TRIM INSIDE		353.31	373.65	374.72	396.13	407.91	470.01	429.32																																																																																																																												
DO	DUMMY TRIM OUTSIDE																																																																																																																																				
DT	FULLY DUMMY		705.54	735.52	750.51	792.27	815.82	897.19	856.50																																																																																																																												
NOTE: Split designs and/or finishes are priced at the highest design and/or finish • Special finishes, consult factory																																																																																																																																					

KNOBS	Round Knob 10	Ball Knob 20	Ball Knob 30	Eclipse Knob 60
				
LEVERS	Stanhope Lever 44	Copa Lever 031	Brompton Lever 55	Monaco Lever 57 Specify handing
				
	Towne Lever 72	Maxwell Lever 77	Omni Lever 78	Plaza Lever 82 Specify handing
				
	Dayton Lever 83 Specify handing	Crescent Lever 86	American Lever 92	Titan Lever 96
				

NEW YORKER PLATE DESIGN NY

		ANSI-A156.13 • Grade 1 3 Hour Fire Rating		Series 5 • 2-3/4" Backset Series 55 • 2-1/2" Backset				
	Standard Features		KNOBS		LEVERS			
	<ul style="list-style-type: none"> • Thru-bolted screwless knob/lever plate assemblies • Independent spring loaded captivated spindles • Reversible mortise lock 2-1/2" or 2-3/4" backset • Lever support springs • Lock front: 1-1/4" x 8" • Dimensions: Ext: 10" H x 2-3/4" W, *Int: 7" H x 2-1/4" W • Cylinder: MARKS "C" keyway, 6 pin w/ 2 keys • Thickness: 1/4" 		10, 20	30, 60	031, 44, 55, 57, 72, 77, 78, 82, 83, 86, 92, 96			
FINISH GROUPS								
MARKS #	FUNCTION	ANSI #	3	26D	3	26D	3	26D
KEYED SINGLE CYLINDER, NO DEADBOLT								
D	OFFICE VEST.		462.51	504.27	522.47	563.15	568.50	611.33
DW	VESTIBULE							
E	OFFICE	F04						
EW	STOREROOM	F07						
J	CLASSROOM	F05						
JM, JR	HOSPITAL	F06						
GL	INSTIT. PRIVACY	F26						
EL	ELECTRICALLY LOCKED		845.80	888.62	907.89	948.58	953.93	99.69
EU	ELECTRICALLY UNLOCKED							
KEYED SINGLE CYLINDER, WITH DEADBOLT								
A	ENTRANCE	F08, F10	480.71	519.26	541.74	582.42	587.78	629.53
B	ENTRANCE	F21						
F	DORMITORY	F12						
FS	DORMITORY							
FW	DORMITORY	F13						
FD	APARTMENT	F20	507.48	549.23	567.43	609.19	615.61	657.37
H	HOTEL	F15						
LH	SPECIAL PRIVACY							
KEYED DOUBLE CYLINDER, NO DEADBOLT								
G	APARTMENT	F09	517.11	568.50	578.14	618.82	624.18	665.93
GC	INTRUDER LATCHBOLT	F32						
GG	CLASSROOM SECURITY							
GR	CLASSROOM SECURITY w/HOLDBACK							
WW	INSTITUTIONAL	F30						
KEYED DOUBLE CYLINDER, WITH DEADBOLT								
AC	ENTRANCE	F35	517.11	568.50	578.14	618.82	624.18	665.93
C	STOREROOM	F14						
FC	INTRUDER DEADBOLT	F34						
FA	DORMITORY	F11						
FX	DORMITORY	F33						
KEYLESS								
N	PASSAGE	F01	342.60	384.36	403.63	444.31	449.66	491.42
L	BATHROOM	F02	480.71	519.26	541.74	582.42	587.78	629.53
LF	PRIVACY	F19						
LJ	PRIVACY	F22	406.84	448.59	467.87	508.55	513.90	556.73
EX	EXIT	F31						
DUMMY TRIM								
DI	DUMMY TRIM INSIDE		175.58	195.93	206.63	225.90	231.26	273.01
DO	DUMMY TRIM OUTSIDE							
DT	FULLY DUMMY		350.10	391.85	410.05	450.73	456.09	499.98

KNOBS & LEVERS ARE PACKED 6 PER CASE

NOTE: Split designs and/or finishes are priced at the highest design and/or finish • Special finishes, consult factory



* Large interior plate available (10" H x 2-3/4" W)

NEW YORKER PLATE DESIGN NY

MARKS #	ANSI-A156.13 • Grade 2		Series 7 • 2-3/4" Backset Series 9 • 2-1/2" Backset					
	Standard Features		KNOBS			LEVERS		
	<ul style="list-style-type: none"> • Thru-bolted screwless knob/lever plate assemblies • Independent spring loaded captivated spindles • Reversible mortise lock 2-1/2" or 2-3/4" backset • Lever support springs • Lock front Series 7: 1-1/4" x 8", Series 9: 1-1/16" x 7-5/8" • Dimensions: Ext: 10" H x 2-3/4" W, *Int: 7" H x 2-1/4" W • Cylinder: MARKS "C" keyway, 6 pin w/ 2 keys 		10, 20		30, 60		031, 44, 65, 57, 72, 77, 78, 82, 83, 86, 92, 96	
FINISH GROUPS								
MARKS #	FUNCTION	ANSI #	3	26D	3	26D	3	26D
KEYED SINGLE CYLINDER, NO DEADBOLT								
D	OFFICE VEST.		427.18	468.94	487.14	527.82	546.02	587.78
DW	VESTIBULE							
KEYED SINGLE CYLINDER, WITH DEADBOLT								
A	ENTRANCE	F08, F10	445.38	483.92	506.41	547.09	552.44	595.27
B	ENTRANCE	F21						
F	DORMITORY	F12						
FS	DORMITORY							
FW	DORMITORY	F13						
KEYED DOUBLE CYLINDER, WITH DEADBOLT								
AC	ENTRANCE	F35	481.78	523.54	542.81	583.49	588.85	630.60
C	STOREROOM	F14						
FX	DORMITORY	F33						
KEYLESS								
N	PASSAGE	F01	309.41	350.10	368.30	408.98	414.33	456.09
L	BATHROOM	F02	445.38	483.92	527.82	547.09	600.38	642.38
LF	PRIVACY	F19						
DUMMY TRIM								
DI	DUMMY TRIM INSIDE		175.58	195.93	206.63	225.90	231.20	273.01
DO	DUMMY TRIM OUTSIDE							
DT	FULLY DUMMY		350.10	391.85	410.05	450.73	456.09	499.98
NOTE: Split designs and/or finishes are priced at the highest design and/or finish • Special finishes, consult factory								
* Large interior plate available (10" H x 2-3/4" W)								





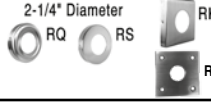



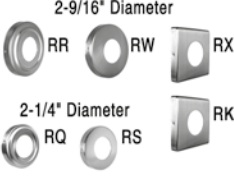

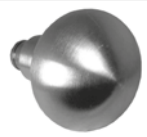











KNOBS	Round Knob 10	Ball Knob 20	Ball Knob 30	Eclipse Knob 60
				
	Stanhope Lever 44	Copa Lever 031	Brompton Lever 55	Monaco Lever 57 Specify handing
				
LEVERS	Towne Lever 72	Maxwell Lever 77	Omni Lever 78	Plaza Lever 82 Specify handing
				
	Dayton Lever 83 Specify handing	Crescent Lever 86	American Lever 92	Titan Lever 96
				

ROSE DESIGN RR, RW, RQ, RS, RX*, RK*, RL*

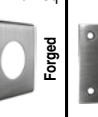
		ANSI-A156.13 • Grade 1 3 Hour Fire Rating			Series 5 • 2-3/4" Backset Series 55 • 2-1/2" Backset					
		Standard Features		KNOBS		LEVERS				
		<ul style="list-style-type: none"> • Thru-bolted screwless knob/lever rose assemblies • Independent spring loaded captivated spindles • Reversible mortise lock 2-1/2" or 2-3/4" backset • Lever support springs • Lock front: 1-1/4" x 8" • Cylinder: MARKS "C" keyway, 6 pin w/ 2 keys 		10, 20	30, 60	031, 44, 55, 57, 72, 77, 78, 82, 83, 86, 92, 96				82, 83, 86, 92, 96
MARKS #		FUNCTION	ANSI #	FINISH GROUPS						
				3, 32D	3E, 15	26, 10B	3, 4, 15, 26D	14, 26, 32	10E, 10B, 19E	32D
KEYED SINGLE CYLINDER, NO DEADBOLT										
D	OFFICE VEST.									
DW	614									
E	OFFICE	F04								
EW	STOREROOM	F07	617.75	681.99	722.67	657.37	698.05	738.73	657.37	
J	CLASSROOM	F05								
JM, JR	HOSPITAL	F06								
GL	INSTIT. PRIVACY	F26								
EL	ELECTRICALLY LOCKED		965.71	1029.95	1070.63	1005.32	1046.00	1074.91	1005.32	
EU	ELECTRICALLY UNLOCKED									
KEYED SINGLE CYLINDER, WITH DEADBOLT										
A	ENTRANCE	F08, F10								
B	ENTRANCE	F21								
F	DORMITORY	F12	631.67	696.98	737.66	672.36	713.04	741.95	672.36	
FS	DORMITORY									
FW	DORMITORY	F13								
FD	APARTMENT	F20								
H	HOTEL	F15	656.30	720.53	761.22	695.91	736.59	765.50	695.91	
LH	SPECIAL PRIVACY									
KEYED DOUBLE CYLINDER, NO DEADBOLT										
G	APARTMENT	F09								
GC	INTRUDER LATCHBOLT	F32								
GG	CLASSROOM SECURITY		664.86	729.10	770.85	704.85	745.16	775.14	704.47	
GR	CLASSROOM SECURITY w/HOLDBACK									
WW	INSTITUTIONAL	F30								
KEYED DOUBLE CYLINDER, WITH DEADBOLT										
AC	ENTRANCE	F35								
C	STOREROOM	F14								
FC	INTRUDER DEADBOLT	F34	664.86	729.10	770.85	704.85	745.16	775.14	704.47	
FA	DORMITORY	F11								
FX	DORMITORY	F33								
KEYLESS										
N	PASSAGE	F01	479.64	611.33	652.01	602.76	644.52	652.01	602.76	
L	BATHROOM	F02	631.67	696.98	737.66	672.36	713.04	741.95	672.36	
LF	PRIVACY	F19								
LJ	PRIVACY	F22	568.50	633.81	674.50	609.19	649.87	678.78	609.19	
EX	EXIT	F31								
DUMMY TRIM										
DI	DUMMY TRIM INSIDE		129.55	159.52	180.94	148.82	169.16	767.64	148.82	
DO	DUMMY TRIM OUTSIDE									
DT	FULLY DUMMY		255.88	320.12	361.87	295.49	336.18	366.16	295.49	
KNOB & LEVERS ARE PACKED 6 PER CASE NOTE: Split designs and/or finishes are priced at the highest design and/or finish • Special finishes, consult factory F17 Dummy Cylinder: Add \$44.00 *Square Rose RX: Add \$30 / *Square Rose RZ: Add \$70 / *Square Rose RK: Add \$100										

ROSE DESIGN RR, RW, RQ, RS, RX*, RK*, RL*

 2-9/16" Diameter RR RW RX 2-1/4" Diameter RQ RS RK		ANSI-A156.13 • Grade 2	Series 7 • 2-3/4" Backset Series 9 • 2-1/2" Backset							
Standard Features		KNOBS			LEVERS					
<ul style="list-style-type: none"> • Thru-bolted screwless knob/lever rose assemblies • Independent spring loaded captivated spindles • Reversible mortise lock 2-1/2" or 2-3/4" backset • Lever support springs • Lock front Series 7: 1-1/4" x 8"; Series 9: 1-1/16" x 7-5/8" • Cylinder: MARKS "C" keyway, 6 pin w/ 2 keys 		10, 20	30, 60		031, 44, 55, 57, 72, 77, 78, 82, 83, 86, 92, 96		82, 83, 86, 92, 96			
MARKS #		FUNCTION	ANSI #	FINISH GROUPS						
				3, 32D	3E, 15	26, 10B	3, 4, 15, 26D	14, 26, 32	10E, 10B, 19E	32D
KEYED SINGLE CYLINDER, NO DEADBOLT										
D	OFFICE VEST.			582.42	646.66	677.71	622.04	662.72	692.70	622.04
DW	VESTIBULE									
KEYED SINGLE CYLINDER, WITH DEADBOLT										
A	ENTRANCE	F08, F10								
B	ENTRANCE	F21								
F	DORMITORY	F12	597.41	661.65	702.33	637.02	677.71	716.25	637.02	
FS	DORMITORY									
FW	DORMITORY	F13								
KEYED DOUBLE CYLINDER, WITH DEADBOLT										
AC	ENTRANCE	F35								
C	STOREROOM	F14	629.53	694.84	735.52	669.14	709.83	739.80	669.14	
FX	DORMITORY	F33								
KEYLESS										
N	PASSAGE	F01	479.64	543.88	584.56	519.26	559.94	588.85	519.26	
L	BATHROOM	F02	597.41	661.65	702.33	637.02	744.09	706.62	637.02	
LF	PRIVACY	F19								
DUMMY TRIM										
DI	DUMMY TRIM INSIDE		129.55	159.52	180.94	148.82	169.16	183.08	148.82	
DO	DUMMY TRIM OUTSIDE									
DT	FULLY DUMMY		255.88	320.12	361.87	295.49	336.18	366.16	295.49	
NOTE: Split designs and/or finishes are priced at the highest design and/or finish • Special finishes, consult factory *Square Rose RX: Add \$30 / *Square Rose RZ: Add \$70 / *Square Rose RK: Add \$100										

KNOBS	Round Knob 10	Ball Knob 20	Ball Knob 30	Eclipse Knob 60	ROSES	RR: 2-9/16" dia.		
								
LEVERS	Stanhope Lever 44	Copa Lever 031	Brompton Lever 55	Monaco Lever 57 Specify handing		RW: 2-9/16" dia.		
						RQ: 2-1/4" dia.		
	Towne Lever 72	Maxwell Lever 77	Omni Lever 78	Plaza Lever 82 Specify handing		RS: 2-1/4" dia.		
								
Dayton Lever 83 Specify handing	Crescent Lever 86	American Lever 92	Titan Lever 96					RX: 2-1/2" sq. RK: 2-1/2" sq. RL: 2-1/2" sq.  Wrought  Forged

ORNAMENTAL IRON

Ornamental Iron

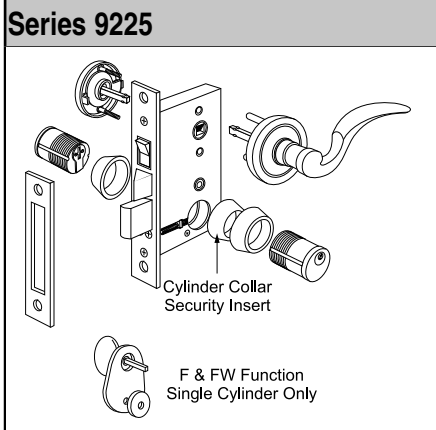
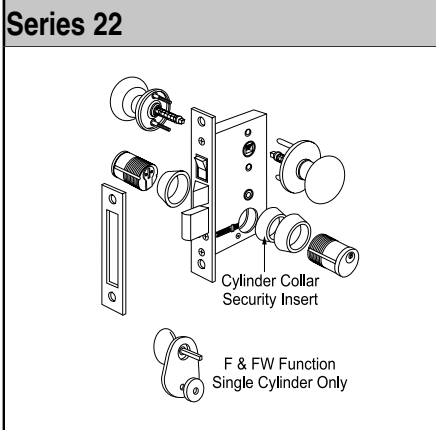
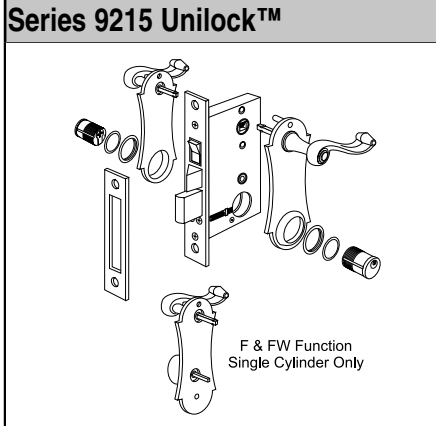
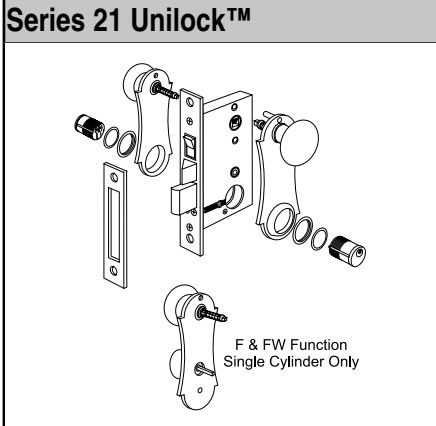

Standard Features		SERIES		
<ul style="list-style-type: none"> • Thru-bolted solid brass trim assemblies • Spring loaded captivated spindles • Reversible mortise lock 1" backset • 1" bolt, 1/2" latch projection • Cylinder: Marks "A" keyway, 5 pin w/ 2 keys; keyed alike - 6 		2750 THINLINE®		
		FINISH GROUPS		
MARKS #	FUNCTION	3	10B	5, 26D
KEYED WITH DEADBOLT				
B	ENTRANCE CYLINDER x TURNPIECE	242.92	306.29	273.43
C	ENTRANCE DOUBLE CYLINDER			
DUMMY TRIM				
DT	FULL DUMMY	146.69	204.19	170.16
ORNAMENTAL IRON LOCKSETS PACKED 6 PER CASE				

Standard Features							
<ul style="list-style-type: none"> • Door thickness: 1" • Series 9 lock body, Backset: 2-1/2" • Reversible mortise lock 1" bolt, 1/2" latch projection • Lock front Series 7: 1-1/4" x 8"; Series 9: 1-1/16" x 7-5/8" • Thru-bolted solid brass trim assemblies • Spring loaded captivated spindles • Cylinder: Marks "A" keyway, 5 pin w/ 2 keys; keyed alike-6 			SERIES 21 UNILOCK™ SERIES 22		SERIES 9215 UNILOCK™ SERIES 9225		
FINISH GROUPS							
MARKS #	FUNCTION	3	10B	5, 26D	3	10B	5, 26D
KEYED SINGLE CYLINDER, WITH DEADBOLT							
DW	SINGLE CYL. PANIC PROOF						
F	SINGLE CYL. PANIC PROOF	326.24	389.61	347.36	435.38	491.71	457.68
FW	SINGLE CYL. PANIC PROOF						
KEYED DOUBLE CYLINDER, WITH DEADBOLT							
AC	ENTRANCE	289.86	356.75	310.99	400.17	457.68	421.30
DUMMY TRIM							
DT	FULL DUMMY	193.63	267.56	207.71	310.99	376.70	326.24
ORNAMENTAL IRON LOCKSETS ARE PACKED 6 PER CASE							

OPTIONS - Series 2750	CODE	PRICE
For 1-3/4" doors	D4	NC
Marks "C" keyway	G5	16

OPTIONS	CODE	PRICE
Lock Front: 1" x 7-1/8" standard	W	NC
Mushroom knob interior; 1-7/8" prj.	A9	5
For 1-3/4" doors	D4	NC
Adjustable spring collars	F10	5

How To Order Example for Ornamental Iron Locksets					
9215	C	/	10B	-	D4
1. Lock Series	2. Marks Function	Slash	3. Finish	Dash	4. Options
LOCK SERIES (Pgs. 49 & 50) <input type="checkbox"/> 21 <input type="checkbox"/> 2750 <input type="checkbox"/> 22 <input type="checkbox"/> 9215	MARKS FUNCTION (Pgs. 57-58) — B — AC — C — DT — F — DW		FINISH (Pg. 10) <input type="checkbox"/> 3 <input type="checkbox"/> 10B <input type="checkbox"/> 5 <input type="checkbox"/> 26D	OPTIONS <input type="checkbox"/> Special Specify • Keying • Handing • Door Thickness	

ORNAMENTAL IRON

Knob & Lever Kits

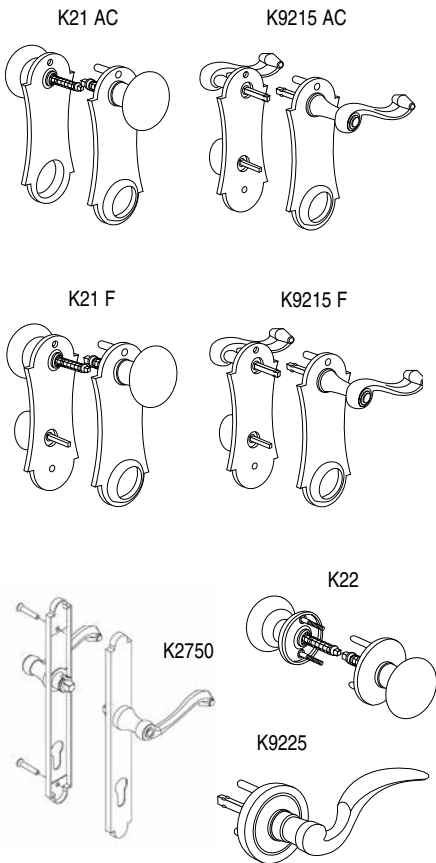

PART #	DESCRIPTION	FUNCTION	FINISH GROUPS			
			3	4	10B	5, 26D
K21AC	Ext./Int. UNILOCK™ knob/plate kit	AC	143.17	—	186.59	158.43
K21AC-M	Ext./Int. UNILOCK™ knob/plate kit (Mushroom Int.)	AC	160.77	—	192.46	165.47
K21F	Ext./Int. UNILOCK™ knob/plate kit assemblies	F	171.34	—	206.54	179.55
K21F-M	Ext./Int. UNILOCK™ knob/plate kit (Mushroom Int.)	F	177.20	—	213.58	186.59
K2750	LEVER PLATE TRIM SET		171.34	—	221.80	194.81
2600B	Thinline lock body, latch, deadbolt US 4 & 26D ONLY - Strike not included		—	142.00	221.80	194.81
K9215AC	Ext./Int. UNILOCK™ lever/plate kit assemblies	AC	215.93	—	255.83	228.84
K9215F	Ext./Int. UNILOCK™ lever/plate kit assemblies	F	215.93	—	280.47	253.48
A9214-M	UNILOCK™ mushroom knob/plate (w/cylinder hole)	AC	79.80	—	111.49	83.32
K9217-M	UNILOCK™ mushroom knob/plate (w/turnpiece)	F	139.65	—	170.16	143.17
K22	Ext./Int. knob/rose kit 1" thru 1-3/4" door		83.32	—	127.91	100.92
K22-M	Ext./Int. knob/rose kit (mushroom int.)		91.54	—	133.78	106.79
K9225	Ext./Int. lever/rose kit		211.24	—	248.79	221.80

Ornamental Iron

Accessories

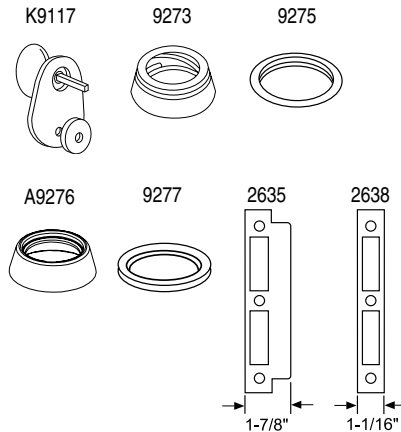

PART #	DESCRIPTION	FINISH GROUPS		
		NO FINISH	3	5, 26D
K9117	Turnpiece kit	—	55.16	58.68
A9223-M	Interior knob/rose assembly (mushroom knob)	—	46.94	55.16
9273	Spring collar, 7/16" high	—	14.08	17.94
9275	Mortise spacer, wrought brass, 1/8" high	—	7.04	—
A9276	Collar, wrought brass w/insert, 1/2" high	—	24.64	24.64
9277	Plastic spacer ring, 1/16"	1.17	—	—
2635	Curved lip strike, solid brass	—	28.16	17.60
2638	Flat strike, solid brass, no lip	—	17.60	8.21

Cylinders

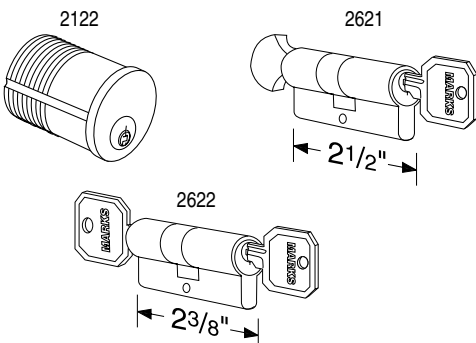

PART #	DESCRIPTION	FINISH GROUPS	
		3	5, 26D
2122-A	5 Pin mortise cylinder, "A" keyway, 15/16"	43.87	46.01
2621-A	Cylinder x turnpiece unit, "A" keyway	71.69	79.69
2622-A	double cylinder unit, "A" keyway	51.36	64.20
2122-C	5 Pin mortise cylinder, "C" keyway	77.42	46.01
2621-C	Cylinder x turnpiece unit, "C" keyway	71.69	79.18
2622-C	double cylinder unit, "C" keyway	51.36	64.20

MORTISE LOCK BODIES

AUTOREVERSE SERIES

GRADE 1
MORTISE LOCKS EXCEEDS
BHMA
SPECIFICATIONS

Mortise Parts, Trim

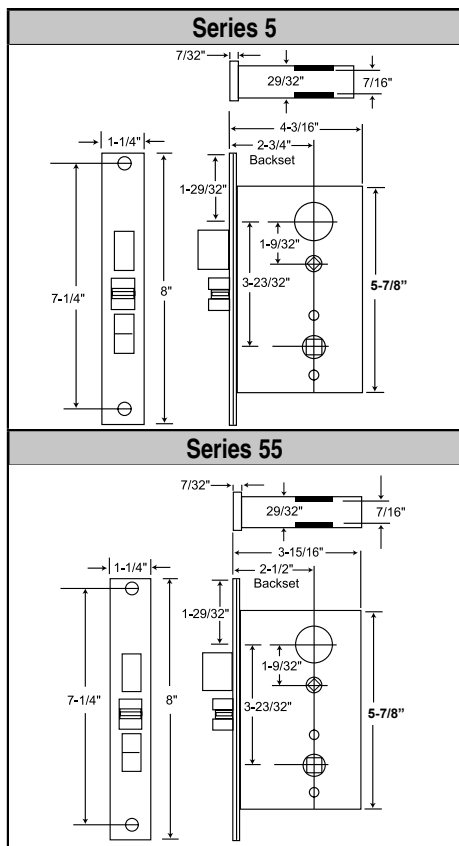

OPTIONS	CODE	PRICE
1-1/16" x 7-5/8" front	T	28
1-1/16" x 7-3/4" front	V	28
1-1/16" x 8" front	Q	28
Lever override guard outside (Series 5)	B1	45
Lever override guard both sides	B2	64
Lever support springs w- 5/16" hubs	B4	20
Hubs with hollow spacer (Series 55)	B6	19
Turnpiece hub on square	B8	12
Screws with Dust Box	B10	NC
Solid latch for electric strike	E1	21
Hold open latch	E2	38
Lead-lined mortise lock	F1	335
4-7/8" Strikes: 1 Left / 1 Right	S6	14
Request to exit switch (Series 5)	W10	140

CYLINDER CAMS REQUIRED	
Locks w/o deadbolt	2101 Straight Cam
Locks w/deadbolt	2102 Cloverleaf Cam
G function (ext. only)	2106 "G" Cam
G function (int. only)	2105 "J" Cam
J function	2105 "J" Cam

* 55 Series Lock Bodies are not available in autoreverse and electrified functions EL and EU.

MARKS #	FUNCTION	ANSI #	Grade 1 for			
			3, 32D	10, 10B, 32		
			Standard Features <ul style="list-style-type: none"> Backset: 5 Series 2-3/4"; 55 Series 2-1/2" Bolt throw: Stainless steel full 1" throw Latch throw: 3/4" (anti-friction) Auxiliary latch: 1/2" throw Case: Stamped steel .090 thick., Zinc dichromate finish Front: 1-1/4" x 8", Adjustable bevel Hubs: Steel, 9/32" on diamond 5/16" on square w/security separator 		Grade 1 for Knobs & Levers Series 5 • 2-3/4" Backset Series 55 • 2-1/2" Backset 	
			FINISH GROUPS			
KEYED SINGLE CYLINDER, NO DEADBOLT						
D	OFFICE / VESTIBULE		339.39	444.31		
DW	VESTIBULE					
E, Q, QH	OFFICE	F04				
K	OFFICE	F04				
EW	STOREROOM	F07				
J	CLASSROOM	F05				
JM, JR	HOSPITAL (HOLDBACK)	F06				
GL	INST. PRIVACY	F26				
MT	ArchiTech		1226.94	1250.50		
EL*	ELECTRICALLY LOCKED*		929.31	949.65		
EU*		ELECTRICALLY UNLOCKED*				
KEYED SINGLE CYLINDER, WITH DEADBOLT						
A	ENTRANCE	F08, F10	356.56	375.79		
B	ENTRANCE	F21				
F	DORMITORY	F12				
FS	DORMITORY					
FW	DORMITORY	F13				
FD	APARTMENT	F20	382.21	402.56		
AD		F27				
H	HOTEL	F15				
LH	SPEC. PRIVACY					
KEYED DOUBLE CYLINDER, NO DEADBOLT						
G	ENTRANCE	F09	390.78	410.05		
GC	INTRUDER LATCHBOLT	F32				
GG	CLASSROOM SECURITY					
GR	CLASSROOM SECURITY w/HOLDBACK					
WW	INSTITUTION	F30				
KEYED DOUBLE CYLINDER, WITH DEADBOLT						
AC	ENTRANCE	F35	390.78	410.05		
C	STOREROOM	F14				
FC	INTRUDER DEADBOLT	F34				
FA	DORMITORY	F11				
FX	DORMITORY	F33				
KEYLESS						
N	PASSAGE	F01	279.43	298.71		
L	BATHROOM	F02	356.52	375.79		
LF	PRIVACY	F19				
LJ	PRIVACY	F19				
EX	EXIT	F31				
MORTISE LOCK BODIES ARE PACKED 6 PER CASE						
* Electrified Functions 5 SERIES ONLY: 2-3/4" Backset ONLY: 100% Duty Cycle 24V/DC, 12V/DC Optional supplied with bridge rectifier (350 ma)						

MORTISE LOCK BODIES

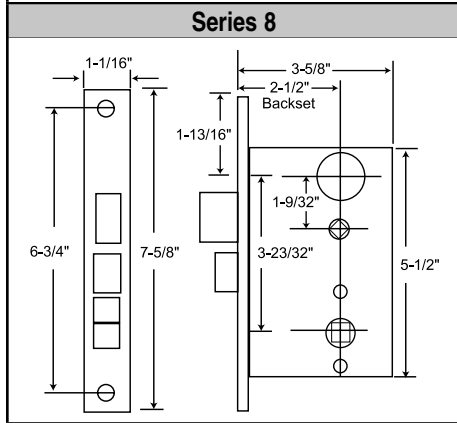
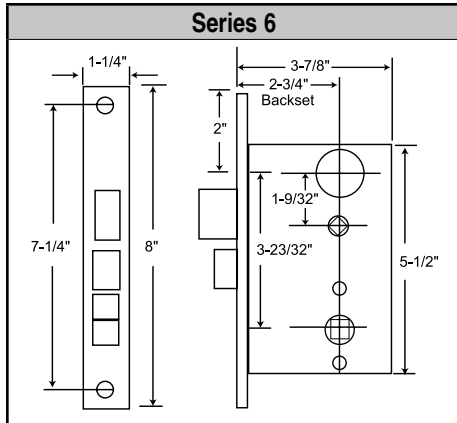

OPTIONS	CODE	PRICE
1-1/16" x 7-5/8" front	T	28
1-1/4" x 10" front, (A function, US 4 only), no mounting holes	U	112
1" x 7-1/8" front, (US 4 only)	W	NC
1-1/4" x 8" front	X	26
1-1/4" x 8-5/8" front (A function, US 4 only)	Y	112
Screws with Dust Box	B10	NC
Solid latch for electric strike	E1	21
4-7/8" Strikes: 1 Left / 1 Right	S6	14
Front 1" x 8"	Z	26

CYLINDER CAMS REQUIRED	
All Functions	2101 Straight Cam

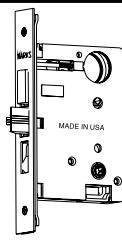
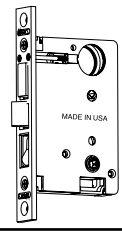
Series 6		Standard Features		Grade 2 for Handlesets Series 6 2-3/4" Backset Series 8 2-1/2" Backset
		<ul style="list-style-type: none"> Backset: 2-3/4" Bolt throw: Cast alloy full 1" throw Latch throw: 5/8" (anti-friction) Case: High pressure cast Zamac, baked enamel finish Front: 1-1/4" x 8", Flat or 3° bevel Hubs: 9/32" (7.2mm) on square 		
		<ul style="list-style-type: none"> Backset: 2-1/2" Bolt throw: Cast alloy full 1" throw Latch throw: Solid brass 1/2" throw, reversible Case: High pressure cast Zamac, baked enamel finish Front: 1-1/16" x 7-5/8", Flat or 3° bevel Hubs: 9/32" on square 		
MARKS #	FUNCTION	ANSI #	FINISH GROUPS	
KEYED SINGLE CYLINDER, NO DEADBOLT				
DW	VESTIBULE		3, 32D	10, 10B, 32
KEYED SINGLE CYLINDER, WITH DEADBOLT				
A	ENTRANCE	F08, F10	358.66	376.86
B	ENTRANCE	F21		
F	DORMITORY	F12		
KEYED DOUBLE CYLINDER, WITH DEADBOLT				
AC	ENTRANCE	F35	375.79	395.06
C	STORE DOOR "B BODY"	F25		
SO	STORE DOOR	F25		
MORTISE LOCK BODIES ARE PACKED 6 PER CASE				

Mortise Parts, Trim

MORTISE LOCK BODIES

Mortise Parts, Trim

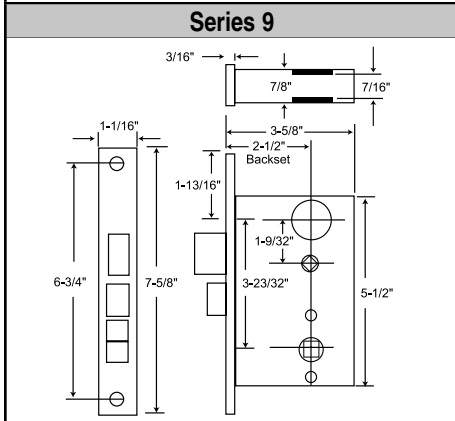
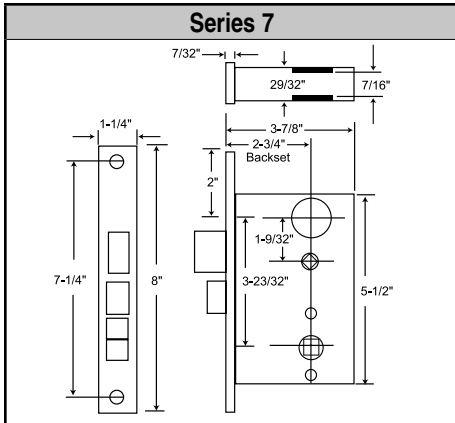

OPTIONS	CODE	PRICE
1-1/16" x 7-5/8" front	T	28
1-1/4" x 10" front, (A function, US 4 only), no mounting holes	U	112
1" x 7-1/8" front, (US 4 only)	W	NC
1-1/4" x 8" front	X	26
1-1/4" x 8-5/8" front (A function, US 4 only)	Y	112
1-1/16" x 8"	T	
Pin and lever springs	B5	38
Screws with Dust Box	B10	NC
Solid latch for electric strike	E1	21
4-7/8" Strikes: 1 Left / 1 Right	S6	14
Front 1" x 8"	Z	26

CYLINDER CAMS REQUIRED
All functions 2101 Straight Cam

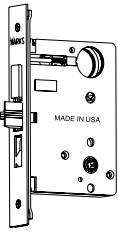
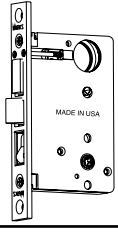

Series 7		Standard Features		Grade 2 for Knobs & Levers Series 7 2-3/4" Backset Series 9 2-1/2" Backset	
		<ul style="list-style-type: none"> Backset: 2-3/4" Bolt throw: Cast alloy full 1" throw Latch throw: 5/8" (anti-friction) Case: High pressure cast Zamac, baked enamel finish Front: 1-1/4" x 8", Flat or 3° bevel Hubs: 9/32" on square steel, w/ security separator 			
Series 9		Standard Features		FINISH GROUPS	
		<ul style="list-style-type: none"> Backset: 2-1/2" Bolt throw: Cast alloy full 1" throw Latch throw: Solid brass 1/2" throw, reversible Case: High pressure cast Zamac, baked enamel finish Front: 1-1/16" x 7-5/8", Flat or 3° bevel Hubs: 9/32" on square steel, w/ security separator 			
MARKS #	FUNCTION	ANSI #	3, 32D	10, 10B, 32	
KEYED SINGLE CYLINDER, NO DEADBOLT					
D	OFFICE / VESTIBULE				
DW	VESTIBULE		305.13	324.40	
KEYED SINGLE CYLINDER, WITH DEADBOLT					
A	ENTRANCE	F08, F10	322.26	339.39	
B	ENTRANCE	F21			
F	DORMITORY	F12			
FS	DORMITORY				
FW	DORMITORY	F13			
KEYED DOUBLE CYLINDER, WITH DEADBOLT					
AC	ENTRANCE	F35	355.45	373.65	
C	STOREROOM	F14			
FA	DORMITORY	F11			
FX	DORMITORY	F33			
KEYLESS					
N	PASSAGE	F01	245.17	263.37	
L	BATHROOM	F02	322.26	339.39	
LF	PRIVACY	F19			
MORTISE LOCK BODIES ARE PACKED 6 PER CASE					

MORTISE DEADLOCKS

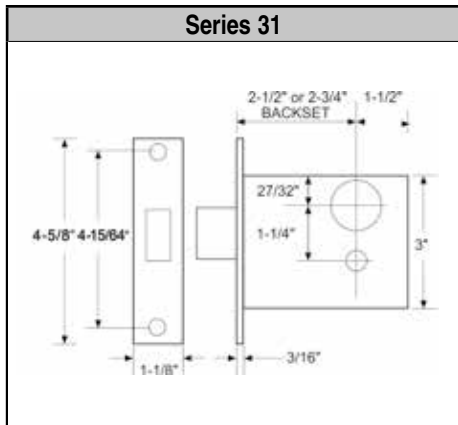
Mortise Parts, Trim



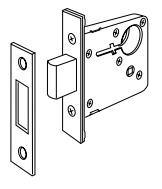

OPTIONS	CODE	PRICE
Security Strike: 4-7/8" x 1-1/4"	S4	12

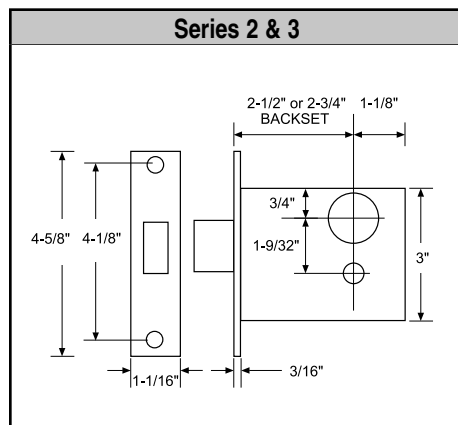

Standard Features			Series 31 2-3/4" Backset	
 <ul style="list-style-type: none"> Backset: Series 31: 2-3/4" Bolt throw: 1" stainless steel with hardened roll pins Case: Stamped Steel, Grade 1 Front: 1-1/16" x 4-5/8" adjustable bevel Cylinder: Solid brass cylinder, 6-pin, "C" keyway, 2 keys Strike: #4035 (Included) 1-1/8" x 3-1/8" Strike: #4035-1 (Optional) 1-1/8" x 3-1/2" 				
			FINISH GROUPS	
MARKS #	FUNCTION	ANSI #	3, 32D	3E, 10, 10B, 26, 32
—	LOCK ONLY	—	199.14	324.40
K, 31K	CYLINDER x TURNPIECE	E06071	263.37	339.39
L, 31L	COMMUNICATING SINGLE CYL.	E06081	235.54	373.65
M, 31M	DOUBLE CYLINDER	E06061	266.59	263.37
S, 31S	CLASSROOM (Specify Handing)	E06091	298.71	339.39
X, 31X	TURNPIECE ONLY		210.91	410.05
MORTISE LOCK BODIES ARE PACKED 6 PER CASE				

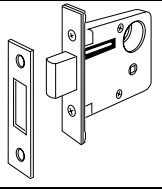

OPTIONS	CODE	PRICE
1-1/16" x 5-5/8" front	R	29

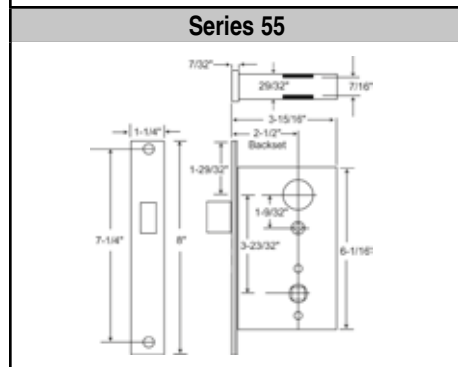
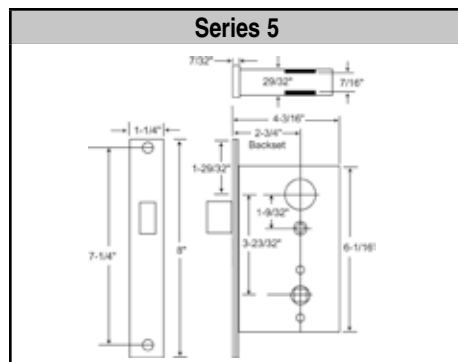
Standard Features			Series 2 • 2-1/2" Backset Series 3 • 2-3/4" Backset	
 <ul style="list-style-type: none"> Backset: Series 2: 2-1/2"; Series 3: 2-3/4" Bolt throw: 1" Case: High pressure cast Front: 1-1/16" x 4-5/8" flat or 3" bevel Cylinder: Solid brass cylinder, 6-pin, "C" keyway, 2 keys Strike: #4035 Included 				
			FINISH GROUPS	
MARKS #	FUNCTION	ANSI #	3, 32D	3E, 10, 10B, 26, 32
—	LOCK ONLY	—	140.25	164.88
K, 2K, 3K	CYLINDER x TURNPIECE	E06071	205.56	226.97
L, 2L, 3L	COMMUNICATING SINGLE CYL.	E06081	179.87	205.56
M, 2M, 3M	DOUBLE CYLINDER	E06061	216.27	238.75
S, 2S, 3S	CLASSROOM (Specify Handing)	E06091	236.61	266.59
X, 2X, 3X	TURNPIECE ONLY		150.96	173.44
MORTISE LOCK BODIES ARE PACKED 6 PER CASE				

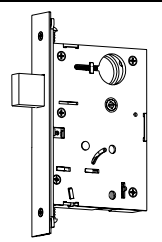

Standard Features			Series 5 • 2-3/4" Backset Series 55 • 2-1/2" Backset	
 <ul style="list-style-type: none"> Backset: Series 5: 2-3/4"; Series 55: 2-1/2" Bolt throw: Stainless steel full 1" throw Case: Stamped steel .090 thick, Zinc dichromate finish Front: 1-1/4" x 8" Adjustable bevel 				
			FINISH GROUPS	
MARKS #	FUNCTION	ANSI #	3, 32D	3E, 10, 10B, 32
T, 5T	DOUBLE CYLINDER	F16	401.49	415.40
P, 5P	CYLINDER x TURNPIECE	F17	368.30	392.92
S, 5S	SINGLE CYLINDER*	F18	339.39	366.16
SC, 5SC	CLASSROOM*	F29	392.92	415.40
MORTISE LOCK BODIES ARE PACKED 6 PER CASE				
*NOTE: Specify handing on "S" and "SC" functions				

OPTIONS	CODE	PRICE
1-1/16" x 7-5/8" front	T	28
1-1/16" x 7-3/4" front	V	28
1" x 1/16" x 8"	Q	28
Lead lined mortise lock	F1	335

MORTISE LOCKSET FUNCTIONS

ANSI #	TYPE	MARKS FUNCTION	ANSI #	TYPE	MARKS FUNCTION	ANSI #	TYPE	MARKS FUNCTION	ANSI #	TYPE	MARKS FUNCTION
F01	Non-Keyed	N	F10	Single Cylinder	A	F19	Non-Keyed	LF	F29	Deadbolt	SC
F02	Non-Keyed	L	F11	Double Cylinder	FA	F20	Single Cylinder	FD	F30	Double Cylinder	WW
F04	Single Cylinder	E	F12	Single Cylinder	F	F21	Single Cylinder	B	F31	Non-Keyed	EX
F05	Single Cylinder	J	F13	Single Cylinder	FW	F22	Non-Keyed	LJ	F32	Double Cylinder	GC
F06	Single Cylinder	JM	F14	Double Cylinder	C	F24	Double Cylinder	C	F33	Double Cylinder	FX
F06	Single Cylinder	JR	F15	Single Cylinder	H	F25	Double Cylinder	C	F34	Double Cylinder	FC
F07	Single Cylinder	EW	F16	Deadbolt	T	F25	Double Cylinder	SO	F35	Double Cylinder	AC
F08	Single Cylinder	A	F17	Deadbolt	P	F26	Single Cylinder	GL			
F09	Double Cylinder	G	F18	Deadbolt	S	F27	Auto Deadbolt	AD			

Mortise Parts, Trim

SINGLE CYLINDER FUNCTIONS

ANSI #	Cam	Strike	Marks Function	
			I/S	O/S
F04: OFFICE Latch by knob/lever either side except when outside knob/lever locked by stop-button in front; then by key outside. Auxiliary latch deadlocks latch. Inside always open.				
	2101	5036		E
F04: OFFICE Latch by knob/lever either side except when outside knob/lever locked by turn piece inside; then by key outside. Auxiliary latch deadlocks latch. Inside always open.				
	2105	5036		K
F05: CLASSROOM Latch by knob/lever either side except when outside knob/lever locked by key. When locked, latch bolt retracted by key. Inside always open. Auxiliary latch deadlocks latch.				
	2105	5036		J
F06: HOLDBACK "A" Latch by knob/lever either side except when outside knob/lever locked or unlocked by key. Auxiliary latch deadlocks latch. Inside always open. Inside knob/lever unlocks outside lever. Latch bolt can be locked in retracted position by locking inside hub. Can be used with blank outside trim.				
	2105	5036		JM
F06: HOLDBACK "B" Latch by knob/lever either side except when outside knob/lever locked or unlocked by key. Auxiliary latch deadlocks latch. Inside always open. Inside knob/lever will not unlock outside knob/lever. Latch bolt can be locked in retracted position by locking outside hub. Can not be used with blank outside trim.				
	2105	5036		JR
F07: STOREROOM Latch by knob/lever inside, key outside. Outside knob/lever always rigid. Auxiliary latch deadlocks latch. Inside always open.				
	2101	5036		EW
F08, F10: ENTRANCE Latch by knob/lever either side except when outside locked by stop-button; then by key outside, knob/lever inside. Deadbolt by key outside, turnpiece inside. Deadbolt deadlocks latch.				
	2102	9035		A
F12: DORMITORY Latch by knob/lever either side except when outside knob/lever locked by stop-button or projected deadbolt. Deadbolt by turnpiece inside. Inside knob/lever retracts latch and deadbolt simultaneously, leaving outside locked. Deadbolt deadlocks latch.				
	2102	9035		F
F13: DORMITORY Latch by knob/lever either side except when projected deadbolt locks outside knob/lever and deadlocks latch. Deadbolt and latch by key outside. Deadbolt by turnpiece inside. Inside knob/lever retracts latch and deadbolt simultaneously, automatically unlocking outside knob/lever.				
	2102	9035		FW
F15: HOTEL Inside knob/lever always free, outside rigid. Latch by knob/lever inside, key outside. (When deadbolt projected by turnpiece all keys are shut out except emergency key). Inside knob/lever retracts deadbolt and latch simultaneously. Auxiliary latch or deadbolt deadlocks latch. Indicator available.				
	2102	5035		H
F20: APARTMENT Latch by knob/lever either side except when outside locked by stop-button or projected deadbolt. Latch deadlocked by auxiliary latch or deadbolt. Deadbolt and latch by key outside. Deadbolt by turnpiece inside. Inside knob/lever retracts latch & deadbolt simultaneously, leaving outside locked.				
	2102	5035		FD

SINGLE CYLINDER FUNCTIONS

ANSI #	Cam	Strike	Marks Function	
			I/S	O/S
F21: ENTRANCE Latch by knob/lever either side. Deadbolt by key outside, turnpiece inside. Deadbolt deadlocks latch.				
	2102	9035		B
F26: INSTITUTIONAL PRIVACY Latch by knob/lever either side except when outside knob/lever locked by inside turn piece. Latch deadlocked by auxiliary latch. Key outside opens latch. When outside locked, inside knob/lever retracts latch, automatically unlocking outside knob/lever.				
	2101	5036		GL
F27: Auto Deadbolt Depressing auxiliary latch projects deadbolt and deadlocks latch. Remains locked even if auxiliary latch is extended. Inside knob/lever retracts both bolts simultaneously. When outside is locked, both bolts are retracted by override key with outside knob/lever.				
	2101	5035		AD
OFFICE VESTIBULE: Latch by knob/lever either side except when outside knob/lever locked by stop-button in front; then by key outside.				
	2101	9035		D
VESTIBULE: Latch by knob/lever inside, key outside. Outside knob/lever always rigid.				
	2101	9035		DW
DORMITORY: Latch by knob/lever inside. Outside knob/lever always rigid. Deadbolt and latch by key outside. Deadbolt by turnpiece inside. When deadbolt is projected, latch is deadlocked. Inside knob/lever retracts latch and deadbolt simultaneously.				
	2102	9035		FS
SPECIAL PRIVACY: Inside knob/lever always free, outside rigid. Latch by knob/lever inside, key outside. Deadbolt by turnpiece inside, emergency release outside. Inside knob/lever retracts deadbolt and latch simultaneously. Auxiliary latch deadlocks latch.				
	2102	5035		LH
STOREROOM: Latch by thumbpiece inside. Key outside.				
	2101	9035		DN
STOREROOM: Latch by thumbpiece or knob/lever inside. Key outside. Auxiliary latch deadlocks latch.				
	2101	5036		EN
ELECTRIFIED FUNCTIONS				
ELECTRICALLY LOCKED (Fail Safe): Outside always locked electrically. Open by key outside, switch or loss of power. Auxiliary latch deadlocks latch. Inside always open.				
	2101	5036		EL
ELECTRICALLY UNLOCKED (Fail Secure): Outside always locked until unlocked by key or electrically energized. Auxiliary latch deadlocks latch. Inside always open.				
	2101	5036		EU

MORTISE LOCKSET FUNCTIONS

DOUBLE CYLINDER FUNCTIONS				
ANSI #	Cam	Strike	Marks Function	
F09: ENTRANCE Latch by knob/lever either side except when outside knob/lever locked by key inside, latch retracted by key outside. Outside remains locked. Auxiliary latch deadlocks latch.	IS 2101 2106	5036	IS O/S	G
F11: DORMITORY Latch by knob/lever either side except when outside knob/lever locked by stop-button or projected deadbolt. Deadbolt by key either side. Inside knob/lever retracts latch and deadbolt simultaneously leaving outside locked. Deadbolt deadlocks latch.	IS 2102	9035		FA
F14: STOREROOM Latch by knob/lever either side. Deadbolt by key either side. Deadbolt deadlocks latch.	IS 2102	9035		C
F24: APARTMENT HANDLE Latch by thumbpiece either side except when outside is locked by key inside. When outside is locked, latch retracted by key outside or thumbpiece inside. Auxiliary latch deadlocks latch.	IS 2101 2106	5036		G
F25: STOREROOM "B" Body Latch by thumbpiece either side. Deadbolt by key either side.	IS 2102	9035		C
F25: STOREROOM Latch by thumbpiece either side except when outside thumbpiece locked by stop-button in front; then by key outside. Deadbolt by key both sides. Deadbolt deadlocks latch.	IS 2102	9035		SO
F30: INSTITUTION Both knob/levers rigid. Auxiliary latch deadlocks latch. Latch by key either side.	IS 2101	5036		WW
F32: INTRUDER LATCH BOLT Latch by knob/lever either side except when outside knob/lever is locked from inside or outside by key. Latch operated by key from inside or outside. Auxiliary latch, deadlocks latch. Inside always open.	IS 2105	5036		GC
CLASSROOM SECURITY Latch bolt retracted by knob/lever from either side unless outside is locked by key from either side. Auxiliary latch deadlocks latch bolt when door is locked. Inside knob/lever is always free for immediate egress.	IS 2101	5036		GG
CLASSROOM SECURITY Latch by lever either side except when outside lever is locked or unlocked by key from either side. With outside locked, exterior key will retract the latch allowing the outside to remain locked. Inside always free for egress. Auxiliary latch deadlocks latch.	IS 2101 2105	5036		GJ
CLASSROOM SECURITY w/HOLDBACK Latch bolt retracted by knob/lever from either side unless outside is locked by key from either side. When locked, latch bolt retracted by key outside or knob/lever inside. Auxiliary latch deadlocks latch bolt when door is locked. Depress inside knob/lever and turn key 360° for holdback feature. Inside knob/lever always free for immediate egress.	IS 2101 2105	5036		GR
F33: DORMITORY Latch by knob/lever either side except when projected deadbolt locks outside knob/lever and deadlocks latch. Deadbolt and latch by key either side. Inside knob/lever retracts latch and deadbolt simultaneously, automatically unlocking outside knob/lever.	IS 2102	9035		FX
F33: DORMITORY Latch by knob/lever either side except when projected deadbolt locks outside knob/lever and deadlocks latch. Deadbolt and latch by key either side. Inside knob/lever retracts latch and deadbolt simultaneously, automatically unlocking outside knob/lever.	IS 2102	5035		FC

DOUBLE CYLINDER FUNCTIONS (Con't)				
ANSI #	Cam	Strike	Marks Function	
F35: STORE DOOR Latch by knob/lever either side except when outside knob/lever locked by stop-button in front; then by key outside. Deadbolt by key either side. Deadbolt deadlocks latch.	IS 2102	9035		AC
NON-KEYED FUNCTIONS				
ANSI #		Strike	Marks Function	
F01: PASSAGE Latch by knob/lever either side.		9035	IS O/S	N
F02: BATHROOM* Latch by knob/lever either side. Deadbolt by turnpiece inside. Deadbolt deadlocks latch. To unlock from outside, remove emergency button, insert emergency key in access hole and turn. Optional coinkey assembly available.		9035		L
F19: PRIVACY* Latch by knob/lever either side except when projected deadbolt locks outside knob/lever and deadlocks latch. Deadbolt by turnpiece inside. Inside knob/lever retracts latch and deadbolt simultaneously, automatically unlocking outside knob/lever. To unlock from outside, remove emergency button, insert emergency key in access hole and turn. Optional coinkey assembly available.		9035		LF
F22: PRIVACY Latch by knob/lever either side except when outside knob/lever is locked by inside turnpiece. Turning inside knob/lever or closing door unlocks outside lever. To unlock from outside, remove emergency button, insert emergency key in access hole and turn. Optional coinkey assembly available.		9035		LJ
F31: EXIT Latch by knob/lever inside, no trim outside. Auxiliary latch deadlocks latch. None removable blank trim: F26 option		5036		EX
DEADBOLT FUNCTIONS				
	IS	Cam		
F16: DEADLOCK Deadbolt by key either side.	2102	2102	9035	T
F17: DEADLOCK Deadbolt by key outside and turnpiece inside.		2102	9035	P
F18: DEADLOCK Deadbolt by key one side only.		2102	9035	S
F29: DEADLOCK Deadbolt by key outside. Inside turnpiece will retract but will not project deadbolt.		2102	9035	SC
DEADLOCK Latch by knob/lever either side. Deadbolt by key either side; latch remained unlocked at all times. Note: With this function deadbolt protrusion is 13/16		2102	9035	CT
DEADLOCK FUNCTIONS				
E06072: CYLINDER BY TURNPIECE Deadbolt by inside turnpiece or outside key.		2102		K
E06082: COMMUNICATING SINGLE CYLINDER* Deadbolt by key from one side only.		2102		L
E06062: DOUBLE CYLINDER Deadbolt by key either side.		2102		M
E06092: CLASSROOM Deadbolt by outside key. Turnpiece will retract but not project deadbolt.		2102		S
TURNPIECE Deadbolt by inside turnpiece.		2102		X
*PRIVACY INDICATOR AVAILABLE				

Mortise Parts, Trim

MORTISE LOCKSET PARTS RK, RL

ROSES	RR: 2-9/16" dia.	RW: 2-9/16" dia.	RQ: 2-1/4" dia.	RS: 2-1/4" dia.	RX: 2-1/2" sq.	*RK: 2-1/2" sq.	*RL: 2-1/2" sq.
					Wrought	Forged	Forged

Knob / Rose Kits

Mortise Parts, Trim

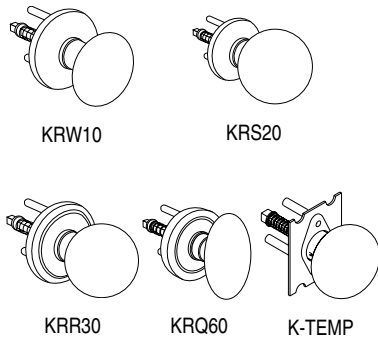

ROSE WITH RING	PLAIN ROSE	SMALL ROSE W/RING	SMALL ROSE	DESCRIPTION	FINISH GROUPS						ROSE RK*
					3	3E	10, 10B	15	26	32D	
KRR10	KRW10	KRQ10	KRS10	Round knob/ball assembly	211	—	—	—	—	211	+130
KRR20	KRW20	KRQ20	KRS20	Ball knob/ball assembly							
KRR30	KRW30	KRQ30	KRS30	Ball knob/ball assembly	—	228	271	297	307	—	
KRR60	KRW60	KRQ60	KRS60	Eclipse knob/ball assembly							
NO FINISH											
K-TEMP				Temporary Trim	73.00						
K-TEMP-G3				Temporary Trim less cyl	56.00						
Complete knob/rose assemblies both sides (includes spindles).											

Lever / Rose Kits

* Specify handing

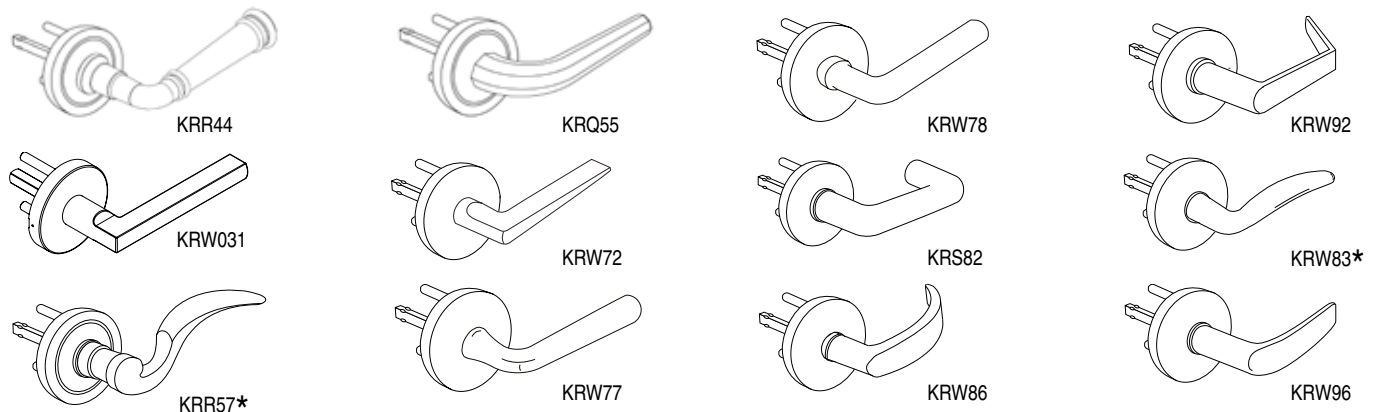

PART #		DESCRIPTION	FINISH GROUPS						ROSE RK*	ROSE RL*
ROSE WITH RING RR	SMALL ROSE WITH RING RQ		3E	4	26D	15	10, 10B, 10E, 26	32D		
		Complete lever/rose assemblies both sides (includes spindles).								
KRR44	KRQ44	Stanhope lever/rose kit	229.11	343.67	343.67	343.67	343.67	—	+111 FOR ALL FINISHES	+36 FOR ALL FINISHES
KRR57	KRQ57	Monaco lever/rose kit	229.11	343.67	343.67	343.67	—	—		
KRR55	KRQ55	Brompton lever/rose kit	229.11	343.67	343.67	343.67	—	—		
		Complete lever/rose assemblies both sides (includes spindles).								
KRW031	KRS031	Copa lever/rose kit	343.67	343.67	—	343.67	343.67	343.67	+111 FOR ALL FINISHES	+36 FOR ALL FINISHES
KRW72	KRS72	Towne lever/rose kit	343.67	343.67	343.67	343.67	389.71	—		
KRW77	KRS77	Maxwell lever/rose kit	343.67	343.67	343.67	343.67	389.71	348.72		
KRW78	KRS78	Omni lever/rose kit	343.67	343.67	343.67	343.67	389.71	348.72		
KRW82	KRS82	Plaza lever/rose kit	343.67	343.67	343.67	343.67	389.71	348.72		
KRW83	KRS83	Dayton lever/rose kit	343.67	343.67	343.67	343.67	389.71	348.72		
KRW86	KRS86	Crescent lever/rose kit	343.67	343.67	343.67	343.67	389.71	—		
KRW92	KRS92	American lever/rose kit	343.67	343.67	343.67	343.67	389.71	348.72		
KRW96	KRS96	Titan lever/rose kit	343.67	343.67	343.67	343.67	389.71	348.72		

MORTISE LOCKSET PARTS

Dummy Cylinder, Collars & Turnpieces

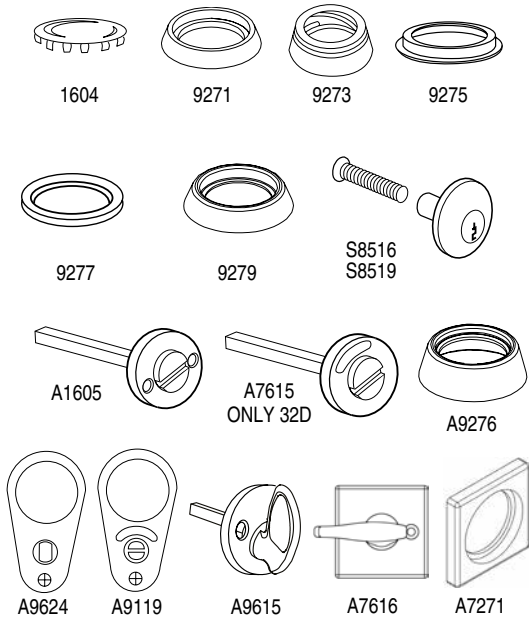

PART #	DESCRIPTION	FINISH GROUPS					
		3E	3, 26D	4	10, 10B, 26	32	32D
1604	Emergency hole cover	—	12.56	—	—	—	—
9271	Tapered collar, solid brass, 5/16" high	40.18	27.88	—	30.14	35.16	30.14
9273	Spring collar, 7/16" high	—	18.84	—	—	—	—
9275	Mortise spacer, wrought brass, 1/8" high	—	11.30	—	—	—	—
9277	Plastic spacer ring, 1/16"	8.79	—	—	—	—	—
9279	Tapered collar, wrought brass, 3/8" high	27.62	21.35	—	27.62	23.86	21.35
S8516	Dummy cylinder, inside	52.74	52.74	—	52.74	—	—
S8519	Dummy cylinder, outside	52.74	52.74	—	52.74	—	—
A1605	Emergency coinkey	84.91	77.73	77.73	77.73	—	—
A7271	Square cylinder collar, 1-3/4" x 5/16"	89.15	81.62	—	81.62	81.62	81.62
A7615	Occupancy indicator	—	—	—	—	—	67.81
A7616	Square Turnpiece Rose	96.69	74.08	96.69	96.69	96.69	96.69
A9276	Collar, wrought brass w/insert, 1/2" high	—	27.62	—	37.67	37.67	37.67
A9624	Hotel indicator plate ass'y for rose trim	115.52	85.39	—	91.66	—	—
A9119	Occupancy indicator plate ass'y for rose trim	—	131.85	—	—	—	—
A9615	Turnpiece	82.87	59.02	82.87	70.32	82.87	70.32

Strikes

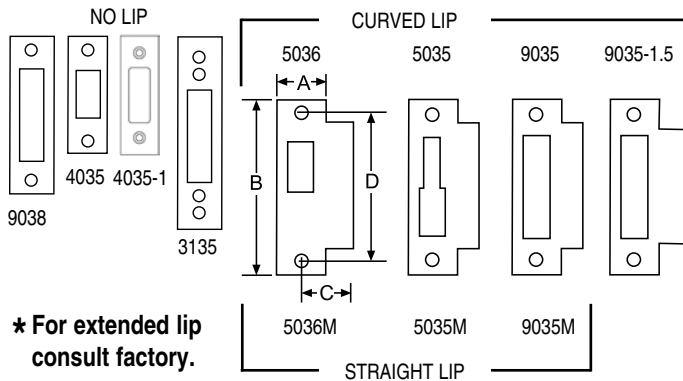

* For extended lip consult factory.

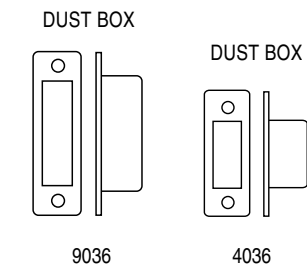

TYPE	PART #	A	B	C*	D	FINISH GROUPS	
						S3	3, 10, 10B, 32, 32D
No Lip	4035	1-1/8"	3-1/8"	—	—	10	18
	4035-1	1-1/8"	3-1/2"	3-1/2"	2-1/2"	—	—
	9038	1-1/8"	4-7/8"	—	2-1/2"	11	—
	3135	1-1/4"	4-7/8"	—	—	—	24
Curved Lip	5035 †	1-1/4"	4-7/8"	1-1/4"	4-1/8"	—	26
	5036 †	1-1/4"	4-7/8"	1-1/4"	4-1/8"	—	26
	9035	1-1/4"	4-7/8"	1-1/4"	4-1/8"	10	26
	9035-1.5	1-1/4"	4-7/8"	1-1/2"	4-1/8"	—	40
Straight Lip	5035M †	1-1/4"	4-7/8"	7/8"	4-1/8"	—	31
	5036M †	1-1/4"	4-7/8"	7/8"	4-1/8"	—	31
	9035M	1-1/4"	4-7/8"	7/8"	4-1/8"	—	31
Dust Box	9036	Dust box for 9038 strike, plastic				10	—
	4036	Dust box for 4035 strike, plastic				8	—

† Specify handing.
Extended lip strikes from 1-1/4" - 2", Add \$16.
*Extended lip strikes over 2", consult factory.

Spindles

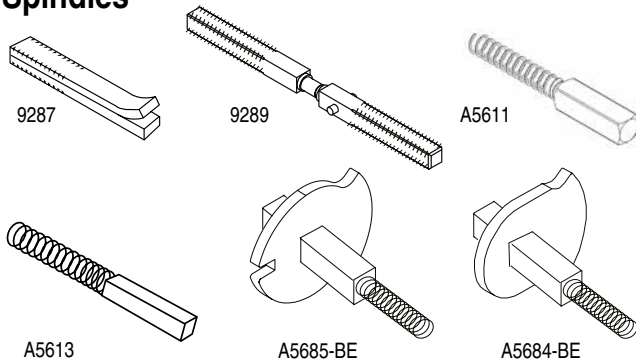

PART #	DESCRIPTION	
9287	2-1/2" LONG, HOOK SPINDLE, 2 PIECE	19.00
9289	4-3/4" LONG, SWIVEL SPINDLE	19.00
A5611	SPINDLE/SPRING ASSEMBLY FOR LEVERS, 5/16", 1" L	19.00
A5613	SPINDLE/SPRING ASSEMBLY FOR LEVERS, 5/16", 1-5/8" L	19.00
A5685-BE	CAM/SPINDLE SPRING ASSEMBLY EXTERIOR	31.00
A5684-BE	CAM/SPINDLE SPRING ASSEMBLY INTERIOR	31.00

TRIM LOCK PARTS



How to Order Example
for Knob & Lever Assemblies

DR	02	-	30	/	15
1. <i>Plate/Rose Design</i>	2. <i>Trim Description</i>	<i>Dash</i>	3. <i>Knob/Lever Design</i>	<i>Slash</i>	4. <i>Finish</i>





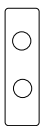

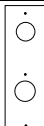
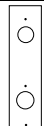
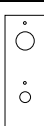



Mortise Parts, Trim

PLATE/ROSE DESIGN		TRIM DESCRIPTION	KNOB DESIGN	FINISH
<input type="checkbox"/> BA	<input type="checkbox"/> RR	<input type="checkbox"/> 01 Outside knob/lever/cylinder	<input type="checkbox"/> 10	<input type="checkbox"/> 3
<input type="checkbox"/> CL	<input type="checkbox"/> RW	<input type="checkbox"/> 02 Inside knob/lever/turnpiece	<input type="checkbox"/> 20	<input type="checkbox"/> 3E
<input type="checkbox"/> CP	<input type="checkbox"/> RQ	<input type="checkbox"/> 03 Inside knob/lever/cylinder	<input type="checkbox"/> 30	<input type="checkbox"/> 4
<input type="checkbox"/> CR	<input type="checkbox"/> RS	<input type="checkbox"/> 04 Inside knob/lever only	<input type="checkbox"/> 60	<input type="checkbox"/> 10
<input type="checkbox"/> DR	<input type="checkbox"/> RX	<input type="checkbox"/> 05 Outside cylinder only		<input type="checkbox"/> 10B
<input type="checkbox"/> DV		<input type="checkbox"/> 06 Outside knob/lever		<input type="checkbox"/> 15
<input type="checkbox"/> GC		<input type="checkbox"/> 07 Outside hotel	LEVER DESIGN	<input type="checkbox"/> 26
<input type="checkbox"/> MA		<input type="checkbox"/> 08 Outside knob/lever only	<input type="checkbox"/> 44	<input type="checkbox"/> 26D
<input type="checkbox"/> NY			<input type="checkbox"/> 55	<input type="checkbox"/> 32D
<input type="checkbox"/> NS			<input type="checkbox"/> 57	<input type="checkbox"/> 32D
<input type="checkbox"/> TN			<input type="checkbox"/> 72	<input type="checkbox"/> Special
			<input type="checkbox"/> 77	
			<input type="checkbox"/> 78	
			<input type="checkbox"/> 82	
			<input type="checkbox"/> 83	
			<input type="checkbox"/> 86	
			<input type="checkbox"/> 92	
			<input type="checkbox"/> 96	
			<input type="checkbox"/> 031	

TRIM LOCK PARTS

PLATE/ROSE DESIGN		3	3E	10	10B	15	26D	32D
CLASSIC CL		102.97	—	102.97	102.97	—	104.22	121.80
CAPITOL CP		167.00	—	164.49	164.49	—	—	153.19
CROWN CR		22.60	—	241.09	241.09	210.95	210.95	210.95
DRAKE DR		254.90	—	277.50	277.50	254.90	254.90	263.69
SCHOOL LA		—	—	—	—	—	—	241.09

TRIM LOCK PARTS

















PLATE/ROSE DESIGN		3	3E	10	10B	15	26D	32D
NEW YORKER NY 10" PLATE		59.02	—	—	—	—	72.83	—
NEW YORKER NS 7" PLATE		43.95	—	—	—	—	59.02	—
2-9/16" DIA. ROSE W-RING RR		139.38	182.07	168.26	168.26	154.45	139.38	139.38
2-9/16" DIA. PLAIN ROSE RW		139.38	182.07	168.26	168.26	154.45	139.38	139.38
2-1/4" DIA. SMALL ROSE W-RING RQ		139.38	182.07	168.26	168.26	154.45	139.38	139.38
2-1/4" DIA. SMALL ROSE RS		139.38	182.07	168.26	168.26	154.45	139.38	139.38
2-1/2" SQ. SQUARE ROSE RX		139.38	182.07	168.26	168.26	154.45	139.38	139.38
2-1/2" SQ. SQUARE ROSE RK		233.56	273.74	259.93	259.93	247.37	233.56	233.56
SQUARE TURNPIECE ROSE A7616	OUTSIDE 	238.58	288.81	274.99	274.99	274.99	248.62	248.62
	INSIDE	76.60	96.69	85.39	85.39	85.39	85.39	85.39
2-1/2" SQ. SQUARE ROSE RL		248.62	288.81	274.99	274.99	261.18	248.62	248.62

Mortise Parts, Trim

TRIM LOCK PARTS

Knob / Lever Design

Mortise Parts, Trim

KNOB/LEVER			FINISH GROUPS								
			3	3E	4	10	10B	15	26	26D	32D
ROUND KNOB		10	124.31	—	—	151.94	151.94	—	151.94	151.94	124.31
BALL KNOB		20	124.31	—	—	151.94	151.94	—	151.94	151.94	124.31
BALL KNOB		30	—	210.95	—	151.94	—	264.95	264.95	—	—
ECLIPSE KNOB		60	—	210.95	—	—	—	264.9	257.41	264.9	—
STANHOPE LEVER		44	—	253.65	253.65	278.76	278.76	253.65	278.76	253.65	248.62
COPA LEVER		031	210.95	253.65	253.65	278.76	278.76	253.65	278.76	253.65	—
MONACO LEVER		57	—	253.65	253.65	278.76	278.76	253.65	278.76	253.65	—
BROMPTON LEVER		55	—	253.65	253.65	278.76	278.76	253.65	278.76	253.65	—
TOWNE LEVER		72	210.95	253.65	253.65	278.76	278.76	253.65	278.76	253.65	—
MAXWELL LEVER		77	210.95	253.65	253.65	278.76	278.76	253.65	278.76	253.65	248.62
OMNI LEVER		78	210.95	253.65	253.65	278.76	278.76	253.65	278.76	253.65	—
PLAZA LEVER		82	210.95	253.65	253.65	278.76	278.76	253.65	278.76	253.65	248.62
DAYTON LEVER		83	210.95	253.65	253.65	278.76	278.76	253.65	278.76	253.65	253.65
CRESCENT LEVER		86	210.95	253.65	253.65	278.76	278.76	253.65	278.76	253.65	248.62
AMERICAN LEVER		92	210.95	253.65	253.65	278.76	278.76	253.65	278.76	253.65	248.62
TITAN LEVER		96	210.95	253.65	253.65	278.76	278.76	253.65	278.76	253.65	248.62

How To Order CYLINDRICAL LOCKSETS

How To Order Example for Cylindrical Locksets					
195	N	/	26D	—	G3
<i>1. Lockset Series</i>	<i>2. Marks Function</i>	<i>Slash</i>	<i>3. Finish</i>	<i>Dash</i>	<i>4. Options</i>

1 SERIES	
Cylindrical Locksets:	110, 110R, 210, 210R, 180, 180R, 280, 280R, 175, 175R, 195, 195R, 295, 295R, 495, 495R

2 CYLINDRICAL FUNCTIONS			
MARKS #	FUNCTION	ANSI	
#			
N	—	PASSAGE	F75
L	—	PRIVACY	F76
LK	—	HOSPITAL/PRIVACY	F76 MOD.
P	—	PATIO	F77
DC	RDC	COMMUNICATING	F80
A	RA	ENTRY	F81
B	RB	ENTRY	F82A
AQ	—	EXIT	F83
S	RS	CLASSROOM	F84
F	RF	STOREROOM	F86
DW	RDW	INSTITUTION	F87
DA	RDA	VESTIBULE	F88
FQ	—	EXIT	F89
T	RT	CORRIDOR	F90
TK	—	HOSPITAL/PRIVACY	F90 MOD.
GB	RGB	STORE DOOR (95 SERIES ONLY)	F91
BS	—	SERVICE STATION LOCK	F92
H	—	HOTEL	F93
AB	RAB	ENTRANCE	F109
DB	RDB	CLASSRM. INTRUDER	F110
NB	—	COMMUNICATING PASSAGE	F111
FB	—	COMMUNICATING STOREROOM	F112
SB	RSB	COMMUNICATING CLASSROOM	F113
FEL	RFEL	ELECTRONICALLY LOCKED	
FEU	RFEU	ELECTRONICALLY UNLOCKED	
DUMMY TRIM			
DO	—	DUMMY TRIM OUTSIDE	
DT	—	FULL DUMMY	

3 FINISH		
MARKS #		ANSI #
US 3	Polished Brass, Clear Coated	605
US 4	Satin Brass, Clear Coated	606, 606E
US 10	Satin Bronze, Clear Coated	612E
US 10B	Dark Bronze, Clear Coated	613E
US 26	Polished Chrome, Plated	625
US 26D	Satin Chrome, Plated	626
US 32	Polished Stainless Steel	629
US 32D	Satin Stainless Steel	630

4 OPTIONS		
TRIM MODIFICATIONS	CODE	PRICE
Tactile knob/lever, coated ext. only	A1	62
Tactile knob/lever, knurled	A4	62
Tactile knob/lever, coated int. & ext.	A18	126
DOOR THICKNESS	CODE	PRICE
2" (50 mm)	D1	NC
2-1/4" (57mm)	D2	75
Over 2-3/8" - 4"	D9	667
LATCH	CODE	PRICE
2-3/4" backset, 1-1/8" x 2-1/4" face	E4	NC
2-3/8" backset, 1" x 2-1/4" face	E6	NC
2-3/4" backset, 9/16" throw, Gr. 1, UL Listed	E7	48
5" backset, 9/16" throw, Gr. 1	E9	48
3-3/4" backset, 9/16" throw, Gr. 1	E10	48
2-3/8" backset, 1-1/8" x 2-1/4" face	E11	13
2-3/4" backset, 1" x 2-1/4" face	E12	13
TRIM CHANGES	CODE	PRICE
Yale conventional	F7	24
Sargent conventional cylinder	F8	24
Corbin conventional cylinder	F9	24
Corbin 6 pin IC core	F12	35
Corbin 7 pin IC core	F13	35
Yale 6 pin IC core	F14	24
Yale 7 pin IC core	F15	24
Schlage 6 pin IC core	F19	24
Sargent IC core	F20	24
Medeco IC core large format	F21	24
CYLINDER	CODE	PRICE
Special optional keyway	G2	38
Less cylinder	G3	Deduct 15
STRIKE	CODE	PRICE
4-7/8" ASA strike	S1	14
2-3/4" "T" strike	S3	NC

80 LINE GRADE 1 CYLINDRICAL KNOBSETS

BHMA CERTIFIED		ANSI-A156.2 • Grade 1 3 Hour Fire Rating		Series 180/180R • 2-3/4" Backset Series 280/280R • 2-3/4" Backset	
80 Series Knobsets Shown Below				Standard Features	
				<ul style="list-style-type: none"> • Backset: 2-3/4" • Latch #1834, Front: 1-1/8" x 2-1/4" • Throw: 9/16"; Stainless steel nose • Knobs: 2-1/4" dia. (180) round; 2-3/16" dia. (280) ball • Roses: Adjustable both sides; Steel reinforced 2-3/4" dia. • Strike: #1135, 4-7/8" ASA curved lip strike • Door thickness: 1-5/8" to 1-7/8" • Cylinder: MARKS "C" keyway, 6 pin w/ 2 keys 	
MARKS #		FUNCTION	ANSI #	FINISH GROUPS	
COMM. CYL.	IC CORE CYL.*			3, 32D	10, 10B, 32
N	—	PASSAGE	F75	478.57	521.40
L	—	PRIVACY	F76	482.85	525.68
P	—	PATIO	F77	482.85	525.68
DC	RDC	COMMUNICATING	F80	559.94	602.76
A	RA	ENTRY	F81	508.55	551.37
B	RB	ENTRY	F82A	508.55	551.37
AB	RAB	ENTRY	F109	508.55	551.37
AQ	—	EXIT	F83	494.63	538.53
S	RS	CLASSROOM	F84	508.55	551.37
F	RF	STOREROOM	F86	508.55	551.37
DW	RDW	INSTITUTION	F87	559.94	602.76
DA	RDA	VESTIBULE	F88	559.94	602.76
FQ	—	EXIT	F89	494.63	538.53
TK	—	HOSPITAL/PRIVACY MOD.	F90	521.40	563.15
BS	RBS	SERVICE STATION LOCK	F92	522.47	564.22
537.35	—	DUMMY TRIM OUTSIDE	—	289.07	310.48
DT	—	FULL DUMMY TRIM	—	398.27	441.10
NB	—	COMMUNICATING PASSAGE	F111	438.96	461.44
FB	RFB	COMMUNICATING STOREROOM	F112	504.27	525.68
SB	RSB	COMMUNICATING CLASSROOM	F113	504.27	525.68
KNOBS ARE PACKED 12 PER CASE					
NOTE: Split designs and/or finishes are priced at the highest design and/or finish • Special finishes, consult factory					
• IC Core Models: Tailpieces included, core not included					
❖ IC Core Models in US3 Finish: Add \$42.00 to list price					

OPTIONS	CODE	PRICE
For 2" doors	D1	NC
For 2-1/4" doors	D2	77
2-3/8" backset, 1" x 2-1/4" face	E6	NC
5" backset, 9/16" throw, Gr. 1	E9	48
3-3/4" backset, 9/16" throw, Gr. 1	E10	48
Less cylinder	G3	Deduct 16
2-3/4" "T" strike	S3	NC

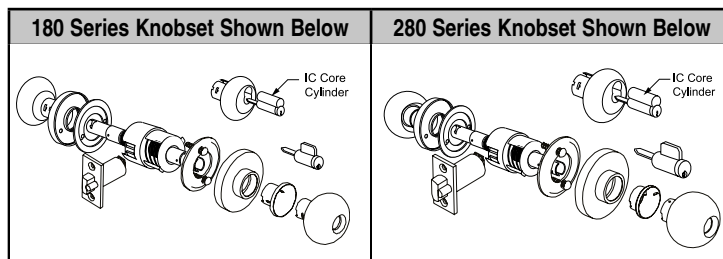



★ **Standard & HI-SECURITY™ IC Core Models:**

Interchangeable Core models for 6 or 7 pin cores (not included).

Accepts: Marks, Marks HI-SECURITY™, Medeco®, KeyMark™, Falcon, Schlage® small format & Best®. **IC Core Tailpieces ARE Included.**

10 LINE GRADE 2 CYLINDRICAL KNOBSETS

BHMA CERTIFIED		ANSI-A156.2 • Grade 2 Plus 3 Hour Fire Rating				Series 110/110R • 2-3/8" Backset Series 210/210R • 2-3/8" Backset	
10 Series Knobsets Shown Below				Standard Features			
 				<ul style="list-style-type: none"> • Backset: 2-3/8" • Latch #1138, Front: 1" x 2-1/4"; Throw: 1/2"; Stainless steel nose • Knobs: 2-1/4" dia. (110) round; 2-3/16" dia. (210) ball • Roses: Adjustable both sides; Steel reinforced 2-3/4" dia. • Strike: #1136, 2-3/4" "T" strike • Door thickness: 1-5/8" to 1-7/8" • Cylinder: MARKS "C" keyway, 6 pin w/ 2 keys 			
MARKS #				FINISH GROUPS			
COMM. CYL.	IC CORE CYL.*	FUNCTION	ANSI #	3, 32D	10, 10B, 32		
N	—	PASSAGE	F75	161.67	206.63		
L	—	PRIVACY	F76	193.78	236.61		
P	—	PATIO	F77	193.78	236.61		
DC	RDC	COMMUNICATING	F80	259.09	302.99		
A	RA	ENTRY	F81	229.11	271.94		
B	RB	ENTRY	F82A	229.11	271.94		
AB	RAB	ENTRY	F109	229.11	271.94		
AQ	—	EXIT	F83	214.13	256.95		
S	RS	CLASSROOM	F84	229.11	271.94		
F	RF	STOREROOM	F86	229.11	271.94		
DW	RDW	INSTITUTION	F87	260.16	304.06		
DA	RDA	VESTIBULE	F88	260.16	304.06		
FQ	—	EXIT	F89	214.13	256.95		
DO	—	DUMMY TRIM OUTSIDE	—	169.16	190.57		
DT	—	FULL DUMMY TRIM	—	177.72	219.48		
NB	—	COMMUNICATING PASSAGE	F111	173.44	194.85		
FB	RFB	COMMUNICATING STOREROOM	F112	243.03	268.73		
SB	RSB	COMMUNICATING CLASSROOM	F113	243.03	268.73		

KNOBS ARE PACKED 12 PER CASE

NOTE: Split designs and/or finishes are priced at the highest design and/or finish • Special finishes, consult factory
 • IC Core Models: Tailpieces included, core not included
 ❖ IC Core Models in US3 Finish: Add \$42.00 to list price

OPTIONS	CODE	PRICE
For 2" doors	D1	NC
For 2-1/4" doors	D2	77
2-3/4" backset, 1-1/8" x 2-1/4" face	E4	NC
2-3/4" backset, 9/16" throw, Gr. 1, UL Listed	E7	96
Solid latch for electric strike	E9	97
3-3/4" backset, 9/16" throw, Gr. 1	E10	96
Less cylinder	G3	Deduct 16
4-7/8" ASA strike with curved lip	S1	14

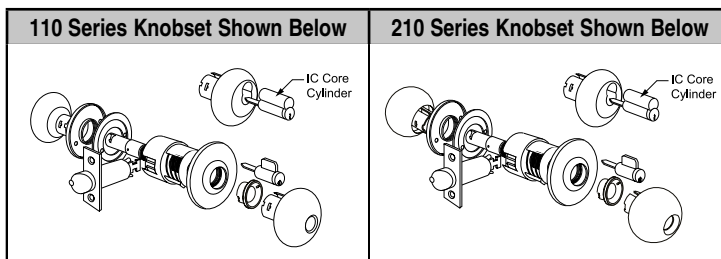

★ **Standard & HI-SECURITY™ IC Core Models:** 
 Interchangeable Core models for 6 or 7 pin cores (not included).
Accepts: Marks, Marks HI-SECURITY™, Medeco®, KeyMark™, Falcon, Schlage® small format & Best®. **IC Core Tailpieces ARE Included.**

95 LINE GRADE 1 CYLINDRICAL SURVIVOR LEVERSETS

BHMA CERTIFIED			ANSI-A156.2 • Grade 1 3 Hour Fire Rating		SURVIVOR SERIES Series 195/195R, 295/295R, 495/495R • 2-3/4" Backset	
95 Series Leversets Shown Below				Standard Features		
				<ul style="list-style-type: none"> • Backset 2-3/4" • Latch #1834, Front: 1-1/8" x 2-1/4"; Throw: 9/16"; Stainless steel nose • Levers: Solid cast Zamac; w/ 1/2" return (except 395 & 495) • Roses: Thru-bolted, 3-7/16" dia., spring loaded 2-#10 thru-bolts • Strike: #1135, 4-7/8" ASA curved lip strike • Door thickness: 1-5/8" to 1-7/8"; For 1-3/8" door use K1904 spacer Cylinder: MARKS "C" keyway, 6 pin w/ 2 keys		
MARKS #		FUNCTION	ANSI #	FINISH GROUPS		
COMM. CYL.	IC CORE CYL.*			3, 26D	4, 10, 10B, 26	
N	—	PASSAGE	F75	458.23	547.09	
L	—	PRIVACY	F76	483.92	578.14	
LK	—	HOSPITAL/PRIVACY	F76 MOD.	516.04	608.12	
P	—	PATIO	F77	478.57	571.72	
DC	RDC	COMMUNICATING	F80	555.66	645.59	
A	RA	ENTRY	F81	504.27	596.34	
B	RB	ENTRY	F82A	504.27	596.34	
AB	RAB	ENTRY	F109	504.27	596.34	
AQ	—	EXIT	F83	489.28	583.49	
S	RS	CLASSROOM	F84	504.27	596.34	
F	RF	STOREROOM	F86	504.27	596.34	
DW	RDW	INSTITUTION	F87	555.66	645.59	
DA	RDA	VESTIBULE	F88	555.66	645.59	
FQ	—	EXIT	F89	489.28	583.49	
T	RT	CORRIDOR	F90	516.04	608.12	
TK	—	HOSPITAL/PRIVACY	F90 MOD.	478.57	571.72	
GB	RGB	STORE DOOR	F91	685.20	747.30	
BS	RBS	SERVICE STATION LOCK	F92	516.04	608.12	
H	—	HOTEL	F93	567.43	657.37	
DB	RDB	CLASSROOM INTRUDER	F110	612.40	705.54	
DO	—	DUMMY TRIM OUTSIDE	—	284.79	374.72	
DT	—	FULL DUMMY TRIM	—	406.84	498.91	
NB	—	COMMUNICATING PASSAGE	F111	432.53	522.47	
FB	RFB	COMMUNICATING STOREROOM	F112	508.55	588.85	
SB	RSB	COMMUNICATING CLASSROOM	F113	508.55	588.85	
FEL	RFEL	ELECTRICALLY LOCKED*	—	736.59	829.74	
FEU	RFEU	ELECTRICALLY UNLOCKED*	—	736.59	829.74	

Marks USA Antimicrobial Finish Available - Option Code: AM - Add \$40

LEVERS ARE PACKED 6 PER CASE

NOTE: Split designs and/or finishes are priced at the highest design and/or finish • Special finishes, consult factory

*ELECTRIFIED FUNCTIONS: 100% Duty Cycle 24V AC/DC, supplied with bridge rectifier : EU - 210 ma; EL - 125 ma • IC Core Models: Tailpieces included, core not included

OPTIONS	CODE	PRICE - 195	295	495
For 2" doors	D1	NC	NC	NC
For 2-1/4" doors	D2	77	77	Call
Over 2-1/4" - 4" thickness	D9	667	667	667
2-3/8" backset, 1" x 2-1/4" face	E6	NC	NC	NC
5" backset, 9/16" throw, Gr. 1	E9	48	48	48
3-3/4" backset, 9/16" throw, Gr. 1	E10	48	48	48
Less cylinder	G3	Deduct 16	-16	-16
2-3/4" "T" strike	S3	NC	NC	NC
AMERICAN LEVER ONLY Accepts:				
Yale conventional cylinder	F7	24	24	—
Sargent conventional cylinder	F8	24	24	—
Corbin conventional cylinder	F9	24	24	—
Corbin 6 pin IC core	F12	35	35	—
Corbin 7 pin IC core	F13	35	—	—
Yale 6 pin IC core	F14	24	24	—
Yale 7 pin IC core	F15	24	—	—
Schlage 6 pin IC core	F19	24	24	—
Sargent IC core	F20	24	24	—
AMERICAN & CRESCENT LEVER ONLY Accepts:				
Medeco IC core large format	F21	24	24	—

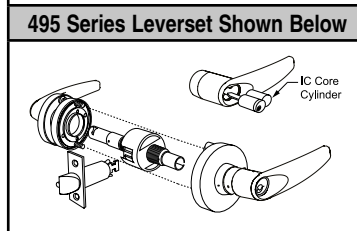
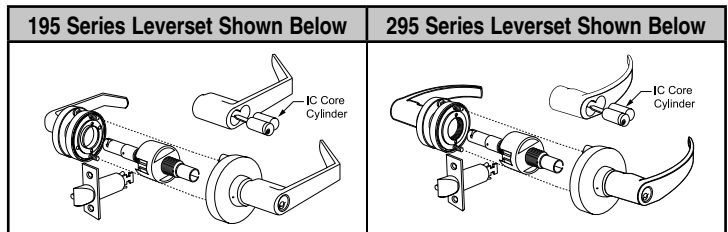

★ **Standard & HI-SECURITY™ IC Core Models:** Interchangeable Core models for 6 or 7 pin cores (not included). **Accepts:** Marks, Marks HI-SECURITY™, Medeco®, KeyMark™, Falcon, Schlage® small format & Best®. **IC Core Tailpieces ARE Included.**



75 LINE GRADE 2 CYLINDRICAL SURVIVOR LEVERSETS

BHMA CERTIFIED			ANSI-A156.2 • Grade 2 Plus 3 Hour Fire Rating		SURVIVOR SERIES Series 175/175R, 275/275R, 475/475R • 2-3/4" Backset		
75 Series Leverset Shown Below					Standard Features		
					<ul style="list-style-type: none"> • Backset: 2-3/4" • Latch #1134, Front: 1-1/8" x 2-1/4"; Throw: 1/2"; Stainless steel nose • Levers: Solid cast Zamac; w/ 1/2" return (except 475) • Roses: Thru-bolted, 3-1/4" dia., spring loaded 2-#10 thru-bolts • Strike: #1145, ASA strike • Door thickness: 1-5/8" to 1-7/8"; <i>For 1-3/8" door use K1904 spacer</i> • Cylinder: MARKS "C" keyway, 6 pin w/ 2 keys 		
MARKS #		FUNCTION	ANSI #	175	275, 475	175, 275, 475	
COMM. CYL.	IC CORE CYL.*			26D	26D	3, 4, 10, 10B, 26	
N	—	PASSAGE	F75	206.12	223.64	245.28	
L	—	PRIVACY	F76	248.38	266.93	287.54	
P	—	PATIO	F77	221.58	240.13	260.74	
DC	RDC	COMMUNICATING	F80	293.72	312.27	332.89	
A	RA	ENTRY	F81	248.38	266.93	287.54	
B	RB	ENTRY	F82A	248.38	266.93	287.54	
AB	RAB	ENTRY	F109	248.38	266.93	287.54	
AQ	—	EXIT	F83	238.07	255.59	287.54	
S	RS	CLASSROOM	F84	248.38	266.93	287.54	
F	RF	STOREROOM	F86	248.38	266.93	287.54	
DW	RDW	INSTITUTION	F87	297.85	318.46	340.10	
DA	RDA	VESTIBULE	F88	299.91	318.46	340.10	
FQ	—	EXIT	F89	238.07	255.59	287.54	
T	RT	CORRIDOR	F90	259.71	278.26	298.88	
BS	RBS	SERVICE STATION LOCK	F92	259.71	278.26	298.88	
H	—	HOTEL	F93	314.33	331.86	353.50	
DO	—	DUMMY TRIM OUTSIDE	—	84.51	102.03	124.70	
DT	—	FULL DUMMY TRIM	—	172.11	189.63	211.27	
NB	—	COMMUNICATING PASSAGE	F111	180.36	195.82	211.27	
FB	RFB	COMMUNICATING STOREROOM	F112	260.74	270.02	281.36	
SB	RSB	COMMUNICATING CLASSROOM	F113	260.74	270.02	281.36	

OPTIONS	CODE	PRICE - 175	275	475
2-3/8" backset, 1" x 2-1/4" face	E6	NC	NC	NC
2-3/4" backset, 9/16" throw, Gr. 1, UL Listed	E7	48	48	96
5" backset, 9/16" throw, Gr. 1	E9	48	48	96
3-3/4" backset, 9/16" throw, Gr. 1	E10	48	48	96
Less cylinder	G3	Deduct 16	-16	-16
2-3/4" T strike	S3	NC	NC	NC
AMERICAN LEVER ONLY Accepts:				
Yale conventional cylinde	F7	24	24	—
Sargent conventional cylinder	F8	24	24	—
Corbin conventional cylinder	F9	24	24	—
Corbin 6 pin IC core	F12	35	35	—
Corbin 7 pin IC core	F13	35	—	—
Yale 6 pin IC core	F14	24	24	—
Yale 7 pin IC core	F15	24	24	—
Schlage 6 pin IC core	F19	24	24	—
Sargent IC core	F20	24	24	—
AMERICAN & CRESCENT LEVER ONLY Accepts:				
Medeco IC core large format	F21	24	24	—

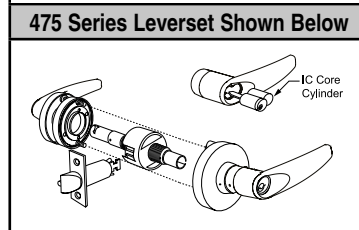
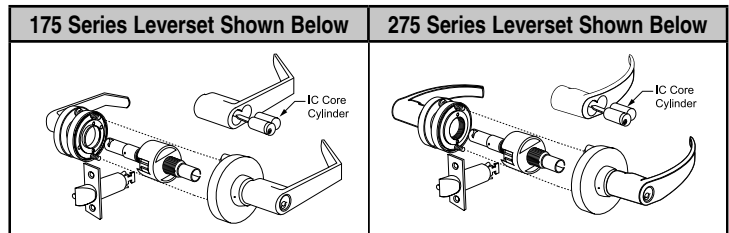

★ Standard & HI-SECURITY™ IC Core Models: Interchangeable Core models for 6 or 7 pin cores (not included). **Accepts:** Marks, Marks HI-SECURITY™, Medeco®, KeyMark™, Falcon, Schlage® small format & Best®. **IC Core Tailpieces ARE Included.**

CYLINDRICAL LOCK ACCESSORIES

Latches, Strikes, Etc.

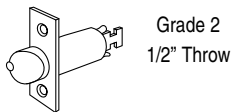

LATCH	THROW	Backset: 2-3/8" Front: 1" x 2-1/4"	Backset: 2-3/4" Front: 1-1/8" x 2-1/4"	FUNCTION	FINISH GROUPS		
					26D	3, 32D	10, 10B
GRADE 2	1/2"	1138A	1134A	ENTRANCE	—	56.51	69.06
		1138L	1134L	PRIVACY	—	41.44	56.51
		1138N	1134N	PASSAGE	—	41.44	56.51
		1138P	1134P	PATIO	—	56.51	69.06
GRADE 1	9/16"	—	1834A	ENTRANCE	—	115.52	125.57
		—	1834L	PRIVACY	—	96.69	115.52
		—	1834N	PASSAGE	—	96.69	115.52
		—	1834P	PATIO	—	96.69	115.52

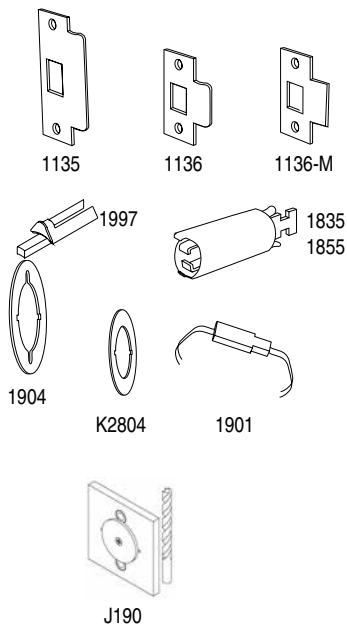

PART	#	DESCRIPTION	FINISH GROUPS	
			3, 32D	10, 10B
STRIKES	1135	4-7/8" ASA strike, curved lip	28.88	28.88
	P1136	2-3/4" "T" strike w/dust box, curved lip	17.58	27.62
	1136-M	2-3/4" "T" strike w/dust box, straight lip	18.84	28.88
SURVIVOR SERIES ALUMINUM SPACER RINGS	K1904	For 1-3/8" door (2 per set), 3-7/16" dia.	50.23	62.78
KNOB SPACER RINGS	K2804	For 1-3/8" door (2 per set), 2-3/4" dia.	50.23	64.04
PART	#	DESCRIPTION	NO FINISH	
EXTENSION LINK <i>For use with 2-3/4" Grade 1 backset latch</i>	1835	3-3/4"	41.44	
	1855	5"		
	1855-P	5" (Grade 1; L, P functions only)		
BRIDGE RECTIFIER	1901	Bridge rectifier 24 V AC/DC (no finish)	62.78	
CYLINDER RETAINER	1997	Lever handle cylinder retainer	7.53	
INSTALLATION TOOL	J295	175/195 installation drill jig	241.09	

CYLINDRICAL LOCK ACCESSORIES

Cylinders

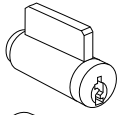

Conventional Cylinder

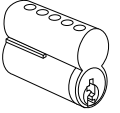

IC Core Cylinder
(Will Fit Best® Housings)

FOR KEYS & KEYING, SEE PAGE 68

Specify Tailpiece; *Tailpiece Not Included.*

PART #	DESCRIPTION	PRICE
1982	6 Pin, w/2 nickel-silver keys	43.95
R1182	6 Pin core, uncombined	55.25
*R1183	7 Pin core, uncombined	55.25
*RA1182	6 Pin core, combined	81.62
*RA1183	7 Pin core, combined	81.62
*RC1182	6 Pin core, construction core	57.76
*RC1187	Plastic core turnknob	10.05

* Consult Factory on pricing of IC Cores when ordered with Locksets.

Cylindrical Lock Tailpieces



1903



1903S



1903-L



1903S-L



F1903-C

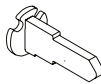

F1903S-C

PART #	CODE	FUNCTION	CYLINDER	PRICE
1903	9	AB, B, DA (ext.), DW, F, FEL, FEU	MARKS 1982	8.79
1903S	S9	S, DA (int.), DB, DC, SB, T		
1903-L	L9	AB, B, DA (ext.), DW, F, FEL, FEU	Arrow PK 100C, Ilco 705, Lori 1539, Sargent 13-3266, Abloy, ASSA 65673, 65691	8.79
1903S-L	SL9	S, DA (int.), DB, DC, SB, T		
F1903-C	—	AB, B, DA (ext.), DW, F, FEL, FEU	Schlage 23-001, Primus, Corbin-Russwin 2000-034	8.79
F1903S-C	—	S, DA (int.), DB, DC, SB, T		

Cylindrical IC Core Tailpieces

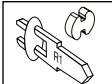

HR1984

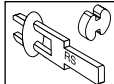

HR1984S

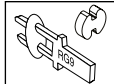

HR1984-G

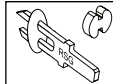

HR1984S-G



AR1989-Y



AR1989S-Y



AR1999-M



AR1999S-M

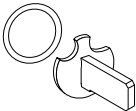

F1903C-F19

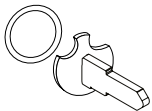

F1903S-F19



R1981



R1983

PART #	CODE	FUNCTION	CORE	PRICE
HR1984	R1	AB, B, DA (ext.), DW, F, FEU, FEL	6 or 7 pin Marks, KSP, Best®, Falcon, Medeco®, Keymark®, Sargent®, Schlage® Small Format	8.79
HR1984S	RS	S, DA (int.), DB, DC, SB, T		
HR1984-G	RG9	AB, B, DA (ext.), DW, F, FEU, FEL	6 or 7 pin Corbin	8.79
HR1984S-G	RSG	S, DA (int.), DB, DC, SB, T		
AR1989-Y	9MY	AB, B, DA (ext.), DW, F, FEU, FEL	6 or 7 pin Yale	11.30
AR1989S-Y	9SY	S, DA (int.), DB, DC, SB, T		
AR1999-M	9M	AB, B, DA (ext.), DW, F, FEU, FEL	Medeco®	11.30
AR1999S-M	9SM	S, DA (int.), DB, DC, SB, T	Medeco®	11.30
F1903C-F19	—	AB, DW, F	6 pin Schlage® Large Format	11.30
F1903S-F19	—	S, DA, DB, DC, SB, T		
R1981		Spacer		8.79
R1983		Security Disc		8.79

For Keying information see Pages 68

CYLINDRICAL KNOB/LEVER FUNCTIONS











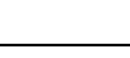

Cylindrical Locksets











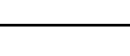

ANSI# CODE	MARKS FUNCTION
F75N
F76L
F76 (MOD.)LK
F77P
F80DC
F81A

ANSI# CODE	MARKS FUNCTION
F82AB
F83AQ
F84S
F86F
F87DW
F88DA

ANSI# CODE	MARKS FUNCTION
F89FQ
F90T
F90 (MOD.)TK
F91 (95 Series Leverset ONLY)	GB
F92BS
F93H

ANSI# CODE	MARKS FUNCTION
F109AB
F110DB
F111NB
F112FB
F113SB







ANSI # CODE	Marks Function	
	I/S	O/S
F75 PASSAGE: Latch by knob/lever either side.		N
F76 PRIVACY: Latch by knob/lever either side unless outside knob/lever locked by push-button from inside. Outside unlocks by turning inside knob/lever, outside emergency turn or closing door.		L
F76 (MOD.) HOSPITAL/PRIVACY: Latch by knob/lever either side unless outside knob/lever locked by push-button from inside. Outside unlocks by turning inside knob/lever, outside turn or closing door. Emergency turn-knob A5 option.		LK
F77 PATIO: Deadlocking latch by knob/lever either side unless outside knob/lever locked by push-button inside. Unlocks by turning inside knob/lever or closing door.		P
F80 COMMUNICATING: Key both sides. Locks or unlocks either knob/lever independent of the other. Deadlocking latch.		DC
F81 ENTRY: Deadlocking latch bolt by knob/lever either side except when outside locked by turn-button inside. When outside locked, key outside or knob/lever inside opens lock. Turn-button operated manually.		A
F82A ENTRY: Deadlocking latch by knob/lever either side. Outside locked by push-button inside. When outside locked by push-button inside, key opens lock, unlocks push-button. Inside knob/lever always opens latch. Closing door does not release push-button.		B
F83 EXIT: Deadlocking latch by knob/lever either side except when outside locked by turn-button inside. Inside knob/lever always opens latch. Turn-button operated manually.		AQ
F84 CLASSROOM: Deadlocking latch by knob/lever inside. Outside knob/lever locked or unlocked by key.		S
F86 STOREROOM: Deadlocking latch by knob/lever inside, key outside. Outside knob/lever always locked.		F
F87 INSTITUTION: Both knob/levers always locked. Deadlocking latch by key both sides.		DW
F88 VESTIBULE: Deadlocking latch by knob/lever either side, except when outside knob/lever locked by key inside. Key outside retracts deadlocking latch. Inside always open.		DA
F89 EXIT: Deadlocking latch by knob/lever inside. Outside always locked.		FQ
F90 CORRIDOR: Deadlocking latch by knob/lever either side unless outside locked by key or inside push-button. Unlock by key, turning inside knob/lever or closing door.		T

ANSI # CODE	Marks Function	
	I/S	O/S
F90 (MOD.) HOSPITAL/PRIVACY: Deadlocking latch by knob/lever either side unless outside locked by knob/lever or inside push-button. Unlock by turn-knob, turning inside knob/lever or closing door. Emergency turn-knob A5 option.		TK
F91 STORE DOOR (95 Series Leverset ONLY): Deadlocking latch by knob/lever either side except when both knob/levers are locked by key from either side.		GB
F92 SERVICE STATION LOCK: Deadlocking latch by knob/lever either side unless outside locked by key or inside push-button. Unlock by key, turning inside knob/lever or closing door, except when slotted push-button is turned in locked position. Inside knob/lever always opens latch.		BS
F93 HOTEL: Deadlocking latch by knob/lever inside. Outside knob/lever always locked. Inside push-button projects indicator on cylinder face shutting out all keys except emergency key. Turning inside knob/lever or closing door releases push-button.		H
F109 ENTRY: Outside locked by pushing turn-button inside. Key outside opens lock. Rotating inside knob/lever releases button and outside knob/lever. By pushing and turning inside button, outside knob/lever remains locked. Deadlocking latch.		AB
F110 CLASSROOM INTRUDER: Deadlocking latch by knob/lever either side, except when outside locked by key inside. Key outside locks or unlocks outside. Inside always open		DB
DUMMY TRIM: Outside only, rigid.		DO
DUMMY TRIM: Both sides, rigid.		DT
F111 COMMUNICATING PASSAGE: Blank outside. Deadlocking latch by knob/lever inside.		NB
F112 COMMUNICATING STOREROOM: Blank outside. Deadlocking latch by key only. Knob/lever always locked.		FB
F113 COMMUNICATING CLASSROOM: Blank outside. Inside knob/lever locked or unlocked by key. Deadlocking latch.		SB
ELECTRICALLY LOCKED - FEL (Fail Safe): Outside always locked electrically. Open by key outside, switch or loss of power. Deadlocking latch by lever inside. Lever only.		FEL
ELECTRICALLY UNLOCKED - FEU (Fail Secure): Outside always locked until unlocked by key or electrically energized. Deadlocking latch by lever inside. Lever only.		FEU

How To ORDER TUBULAR LOCKSETS

How To Order Example for Tubular Locksets																																																																																								
1	RW	92	N	/	32D	—	S3																																																																																	
1. Lockset Series	2. Rose Design	3. Knob/Lever	4. Marks Function	Slash	5. Finish	Dash	6. Options																																																																																	
1 SERIES			5 FINISH																																																																																					
Tubular Locksets Cylindrical Cartridge			<table border="1"> <thead> <tr> <th>MARKS</th> <th></th> <th>ANSI #</th> </tr> </thead> <tbody> <tr><td>US 3</td><td>Polished Brass, Clear Coated</td><td>605</td></tr> <tr><td>US 3E</td><td>Polished Brass "PVD"</td><td>605E</td></tr> <tr><td>US 4</td><td>Satin Brass, Clear Coated</td><td>606, 606E</td></tr> <tr><td>US10</td><td>Satin Bronze, Clear Coated</td><td>612E</td></tr> <tr><td>US 10B</td><td>Dark Bronze, Clear Coated</td><td>613E</td></tr> <tr><td>US15</td><td>Satin Nickel</td><td>619, 619E</td></tr> <tr><td>US 26</td><td>Polished Chrome, Plated</td><td>625</td></tr> <tr><td>US 26D</td><td>Satin Chrome, Plated</td><td>626</td></tr> <tr><td>US 32</td><td>Polished Stainless Steel</td><td>629</td></tr> <tr><td>US 32D</td><td>Satin Stainless Steel</td><td>630</td></tr> </tbody> </table>					MARKS		ANSI #	US 3	Polished Brass, Clear Coated	605	US 3E	Polished Brass "PVD"	605E	US 4	Satin Brass, Clear Coated	606, 606E	US10	Satin Bronze, Clear Coated	612E	US 10B	Dark Bronze, Clear Coated	613E	US15	Satin Nickel	619, 619E	US 26	Polished Chrome, Plated	625	US 26D	Satin Chrome, Plated	626	US 32	Polished Stainless Steel	629	US 32D	Satin Stainless Steel	630																																																
MARKS		ANSI #																																																																																						
US 3	Polished Brass, Clear Coated	605																																																																																						
US 3E	Polished Brass "PVD"	605E																																																																																						
US 4	Satin Brass, Clear Coated	606, 606E																																																																																						
US10	Satin Bronze, Clear Coated	612E																																																																																						
US 10B	Dark Bronze, Clear Coated	613E																																																																																						
US15	Satin Nickel	619, 619E																																																																																						
US 26	Polished Chrome, Plated	625																																																																																						
US 26D	Satin Chrome, Plated	626																																																																																						
US 32	Polished Stainless Steel	629																																																																																						
US 32D	Satin Stainless Steel	630																																																																																						
2 ROSES			6 OPTIONS																																																																																					
<table border="1"> <thead> <tr> <th>ROSES</th> <th></th> <th>DESIGN</th> </tr> </thead> <tbody> <tr><td>9602-R</td><td>Rose with ring 2-9/16" dia.</td><td>RR</td></tr> <tr><td>9602</td><td>Plain rose 2-9/16" dia.</td><td>RW</td></tr> <tr><td>5602-R</td><td>Small rose with ring 2-1/4" dia.</td><td>RQ</td></tr> <tr><td>5602</td><td>Small rose 2-1/4" dia.</td><td>RS</td></tr> <tr><td>7602</td><td>Square rose 2-9/16" square</td><td>RX</td></tr> <tr><td>7607</td><td>Square forged rose 2-9/16" square</td><td>RK</td></tr> </tbody> </table>			ROSES		DESIGN	9602-R	Rose with ring 2-9/16" dia.	RR	9602	Plain rose 2-9/16" dia.	RW	5602-R	Small rose with ring 2-1/4" dia.	RQ	5602	Small rose 2-1/4" dia.	RS	7602	Square rose 2-9/16" square	RX	7607	Square forged rose 2-9/16" square	RK	<table border="1"> <thead> <tr> <th>TRIM MODIFICATIONS</th> <th>CODE</th> <th>PRICE</th> </tr> </thead> <tbody> <tr><td>Tactile knob/lever, coated ext. only</td><td>A1</td><td>62</td></tr> <tr><td>Tactile knob/lever, knurled</td><td>A4</td><td>62</td></tr> <tr><td>Tactile knob/lever, coated int. & ext.</td><td>A18</td><td>126</td></tr> <tr> <th>DOOR THICKNESS</th> <th>CODE</th> <th>PRICE</th> </tr> <tr><td>1-3/4"</td><td>D4</td><td>NC</td></tr> <tr><td>1-3/8"</td><td>D5</td><td>NC</td></tr> <tr> <th>LATCH</th> <th>CODE</th> <th>PRICE</th> </tr> <tr><td>2-3/4" backset, 1-1/8" x 2-1/4" face</td><td>E4</td><td>11</td></tr> <tr><td>2-3/4" backset, 9/16" throw, Gr. 1, UL Listed With Cylindrical Cartridge*</td><td>E7</td><td>110</td></tr> <tr><td>2-3/8" backset, 1-1/8" x 2-1/4" face</td><td>E11</td><td>14</td></tr> <tr><td>2-3/4" backset, 1 x 2-1/4" face</td><td>E12</td><td>14</td></tr> <tr><td>Adjustable latch 1-1/8" x 2-1/4" face</td><td>E13</td><td>11</td></tr> <tr> <th>TRIM CHANGES</th> <th>CODE</th> <th>PRICE</th> </tr> <tr><td>For 1-1/2" bore</td><td>F6</td><td>18</td></tr> <tr> <th>STRIKE</th> <th>CODE</th> <th>PRICE</th> </tr> <tr><td>4-7/8" ASA strike</td><td>S1</td><td>14</td></tr> <tr><td>2-3/4" "T" strike</td><td>S3</td><td>NC</td></tr> <tr><td>3-5/8" Security strike</td><td>S4</td><td>12</td></tr> <tr><td>2-1/4" Curved lip strike</td><td>S5</td><td>NC</td></tr> </tbody> </table>					TRIM MODIFICATIONS	CODE	PRICE	Tactile knob/lever, coated ext. only	A1	62	Tactile knob/lever, knurled	A4	62	Tactile knob/lever, coated int. & ext.	A18	126	DOOR THICKNESS	CODE	PRICE	1-3/4"	D4	NC	1-3/8"	D5	NC	LATCH	CODE	PRICE	2-3/4" backset, 1-1/8" x 2-1/4" face	E4	11	2-3/4" backset, 9/16" throw, Gr. 1, UL Listed With Cylindrical Cartridge*	E7	110	2-3/8" backset, 1-1/8" x 2-1/4" face	E11	14	2-3/4" backset, 1 x 2-1/4" face	E12	14	Adjustable latch 1-1/8" x 2-1/4" face	E13	11	TRIM CHANGES	CODE	PRICE	For 1-1/2" bore	F6	18	STRIKE	CODE	PRICE	4-7/8" ASA strike	S1	14	2-3/4" "T" strike	S3	NC	3-5/8" Security strike	S4	12	2-1/4" Curved lip strike	S5	NC
ROSES		DESIGN																																																																																						
9602-R	Rose with ring 2-9/16" dia.	RR																																																																																						
9602	Plain rose 2-9/16" dia.	RW																																																																																						
5602-R	Small rose with ring 2-1/4" dia.	RQ																																																																																						
5602	Small rose 2-1/4" dia.	RS																																																																																						
7602	Square rose 2-9/16" square	RX																																																																																						
7607	Square forged rose 2-9/16" square	RK																																																																																						
TRIM MODIFICATIONS	CODE	PRICE																																																																																						
Tactile knob/lever, coated ext. only	A1	62																																																																																						
Tactile knob/lever, knurled	A4	62																																																																																						
Tactile knob/lever, coated int. & ext.	A18	126																																																																																						
DOOR THICKNESS	CODE	PRICE																																																																																						
1-3/4"	D4	NC																																																																																						
1-3/8"	D5	NC																																																																																						
LATCH	CODE	PRICE																																																																																						
2-3/4" backset, 1-1/8" x 2-1/4" face	E4	11																																																																																						
2-3/4" backset, 9/16" throw, Gr. 1, UL Listed With Cylindrical Cartridge*	E7	110																																																																																						
2-3/8" backset, 1-1/8" x 2-1/4" face	E11	14																																																																																						
2-3/4" backset, 1 x 2-1/4" face	E12	14																																																																																						
Adjustable latch 1-1/8" x 2-1/4" face	E13	11																																																																																						
TRIM CHANGES	CODE	PRICE																																																																																						
For 1-1/2" bore	F6	18																																																																																						
STRIKE	CODE	PRICE																																																																																						
4-7/8" ASA strike	S1	14																																																																																						
2-3/4" "T" strike	S3	NC																																																																																						
3-5/8" Security strike	S4	12																																																																																						
2-1/4" Curved lip strike	S5	NC																																																																																						
3 KNOB/LEVER			* E7 Option Available: 2-3/8", 2-3/4", 3-3/4" & 5" Backset, for N Function ONLY.																																																																																					
<table border="1"> <thead> <tr> <th>KNOBS</th> <th></th> <th>DESIGN</th> </tr> </thead> <tbody> <tr><td>1153</td><td>Round, wrought</td><td>10</td></tr> <tr><td>1253</td><td>Ball, wrought</td><td>20</td></tr> <tr><td>9631</td><td>Ball, forged</td><td>30</td></tr> <tr><td>9609</td><td>Eclipse, forged</td><td>60</td></tr> <tr> <th>LEVERS</th> <th></th> <th>DESIGN</th> </tr> <tr><td>SF031</td><td>Copa</td><td>031</td></tr> <tr><td>5657</td><td>Monaco</td><td>57</td></tr> <tr><td>5672</td><td>Towne</td><td>72</td></tr> <tr><td>5677</td><td>Maxwell</td><td>77</td></tr> <tr><td>5678</td><td>Omni</td><td>78</td></tr> <tr><td>5682</td><td>Plaza</td><td>82</td></tr> <tr><td>5683</td><td>Dayton</td><td>83</td></tr> <tr><td>5686</td><td>Crescent</td><td>86</td></tr> <tr><td>5692</td><td>American</td><td>92</td></tr> <tr><td>5696</td><td>Titan</td><td>96</td></tr> </tbody> </table>			KNOBS		DESIGN	1153	Round, wrought	10	1253	Ball, wrought	20	9631	Ball, forged	30	9609	Eclipse, forged	60	LEVERS		DESIGN	SF031	Copa	031	5657	Monaco	57	5672	Towne	72	5677	Maxwell	77	5678	Omni	78	5682	Plaza	82	5683	Dayton	83	5686	Crescent	86	5692	American	92	5696	Titan	96																																						
KNOBS		DESIGN																																																																																						
1153	Round, wrought	10																																																																																						
1253	Ball, wrought	20																																																																																						
9631	Ball, forged	30																																																																																						
9609	Eclipse, forged	60																																																																																						
LEVERS		DESIGN																																																																																						
SF031	Copa	031																																																																																						
5657	Monaco	57																																																																																						
5672	Towne	72																																																																																						
5677	Maxwell	77																																																																																						
5678	Omni	78																																																																																						
5682	Plaza	82																																																																																						
5683	Dayton	83																																																																																						
5686	Crescent	86																																																																																						
5692	American	92																																																																																						
5696	Titan	96																																																																																						
4 TUBULAR FUNCTIONS																																																																																								
<table border="1"> <thead> <tr> <th>MARKS #</th> <th></th> <th>ANSI #</th> </tr> </thead> <tbody> <tr><td>N</td><td>PASSAGE</td><td>F75</td></tr> <tr><td>L</td><td>PRIVACY</td><td>F76</td></tr> <tr><td>NB</td><td>COMMUNICATING</td><td>F111</td></tr> <tr><td>DI</td><td>DUMMY TRIM INSIDE</td><td></td></tr> <tr><td>DO</td><td>DUMMY TRIM OUTSIDE</td><td></td></tr> <tr><td>DT</td><td>FULL DUMMY</td><td></td></tr> </tbody> </table>			MARKS #		ANSI #	N	PASSAGE	F75	L	PRIVACY	F76	NB	COMMUNICATING	F111	DI	DUMMY TRIM INSIDE		DO	DUMMY TRIM OUTSIDE		DT	FULL DUMMY																																																																		
MARKS #		ANSI #																																																																																						
N	PASSAGE	F75																																																																																						
L	PRIVACY	F76																																																																																						
NB	COMMUNICATING	F111																																																																																						
DI	DUMMY TRIM INSIDE																																																																																							
DO	DUMMY TRIM OUTSIDE																																																																																							
DT	FULL DUMMY																																																																																							

TUBULAR KNOB/LEVER FUNCTIONS

ANSI # CODE	Marks Function	ANSI # CODE	Marks Function
	I/S O/S		I/S O/S
F75 PASSAGE: Latch by knob/lever either side.	 N	DUMMY TRIM INSIDE: Dummy trim inside ONLY.	 DI
F76 PRIVACY: Latch by knob/lever either side unless outside knob/lever locked by push-button from inside. Outside unlocks by turning inside knob/lever, outside emergency turn or closing door.	 L	DUMMY TRIM OUTSIDE: Dummy trim outside ONLY.	 DO
F111 COMMUNICATING: Blank outside. Deadlocking latch by knob/lever inside.	 NB	FULL DUMMY TRIM: Dummy trim both sides.	 DT





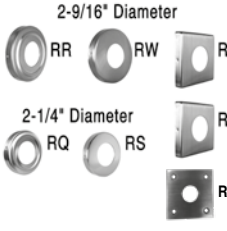





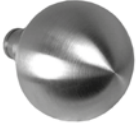











ROSE DESIGN RR, RW, RQ, RS, RX*, RK*, RL*

Tubular Locksets

ANSI-A156 • Grade 2			Series 1 • 2-3/8" Backset						
Standard Features			KNOBS			LEVERS			
 <ul style="list-style-type: none"> • Backset: 2-3/8", 2-3/4" optional • Front: 1" x 2-1/4" • Thru-bolted screwless knob/lever rose • Concealed mounting screws • Lever support springs • Independent spring loaded captivated spindles • Strike: 2-1/4" full curved lip • Latch support housing • Door thickness: 1-3/8" to 1-3/4" • Privacy function - interior with automatic release 			10, 20	30, 60		031, 44, 55, 57, 72, 77, 78, 82, 83, 86, 92, 96		82, 83, 86, 92, 96, 031	
MARKS #			FUNCTION			ANSI #			
KEYLESS			FINISH GROUPS						
			3, 32D	3E, 15	10B, 26	3E, 4, 15, 26D	10E, 10B, 19E 14, 26	32, 32D	
N	PASSAGE	F75	259.09	330.82	371.51	347.95	389.71	335.11	
L	PRIVACY	F76	270.87	342.60	384.36	359.73	401.49	346.88	
NB	COMMUNICATING	F111	317.98	425.04	359.73	336.18	376.86	324.40	
DUMMY TRIM									
DI	DUMMY TRIM INSIDE		120.98	156.31	233.40	167.02	186.29	158.45	
DO	DUMMY TRIM OUTSIDE								
DT	FULLY DUMMY		241.96	313.69	354.38	330.82	371.51	317.98	

KNOBS & LEVERS ARE PACKED 16 PER CASE

NOTE: Split designs and/or finishes are priced at the highest design and/or finish • Special finishes, consult factory
 *Square Rose RX: Add \$30 / *Square Rose RZ: Add \$70 / *Square Rose RK: Add \$100

KNOBS	Round Knob 10	Ball Knob 20	Ball Knob 30	Eclipse Knob 60	ROSES	RR: 2-9/16" dia.	
							RW: 2-9/16" dia.
							RQ: 2-1/4" dia.
							RS: 2-1/4" dia.
					RX: 2-1/2" sq. RK: 2-1/2" sq. RL: 1-1/2" sq.		
							

OPTIONS	CODE	PRICE	NOTE
1-3/8" door thickness	D5	NC	
2-3/4" backset, 1-1/8" x 2-1/4" face	E4	6	
2-3/4" backset, 9/16" throw, Gr. 1, UL Listed WITH CYLINDRICAL CARTRIDGE *	E7	52	N Function Only
2-3/8" backset, 1-1/8" x 2-1/4" face	E11	7	
2-3/4" backset, 1" x 2-1/4" face	E12	7	
4-7/8" ASA strike	S1	7	
2-3/4" "T" strike	S3	NC	
US 26 Interior	x26	12	83, 92, 96 Only

* E7 Option Available: 2-3/8", 2-3/4", 3-3/4" & 5" Backset, for N Function ONLY.

INTERIOR TUBULAR LOCKSETS



NEW! 60 Series, Stainless Steel, Commercial Locksets

Standard Features

- Latch Face: 1" x 2-1/4" standard
- Backset: 2-3/4" with 2-3/4" T-strike with square corners
- Door thickness: 1-3/8" to 1-3/4"
- Roses: 2-9/16" diameter
- Backset: 2-3/8" with 2-1/4", radius corner full lip strike, option E6, N/C
- Privacy Function with kick-off latch

MARKS #	FUNCTION	ANSI #	FINISH GROUPS (160, 260 & 360)	
				32D
N	PASSAGE	F75		154.17
L	PRIVACY	F76		165.95
DO	DUMMY TRIM OUTSIDE	—		77.09

LEVERS ARE PACKED 9 PER CASE Additional finishes, consult factory

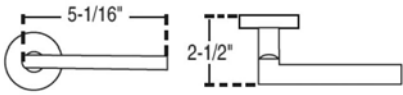
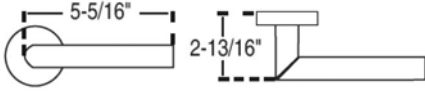
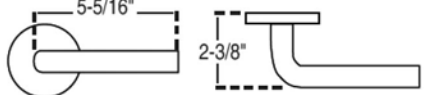
160 Series Finishes: 32D	260 Series Finishes: 32D	360 Series Finishes: 32D
		
		

TUBULAR LOCKSET ACCESSORIES

Strikes, Latches, Support Housing

Tubular Locksets

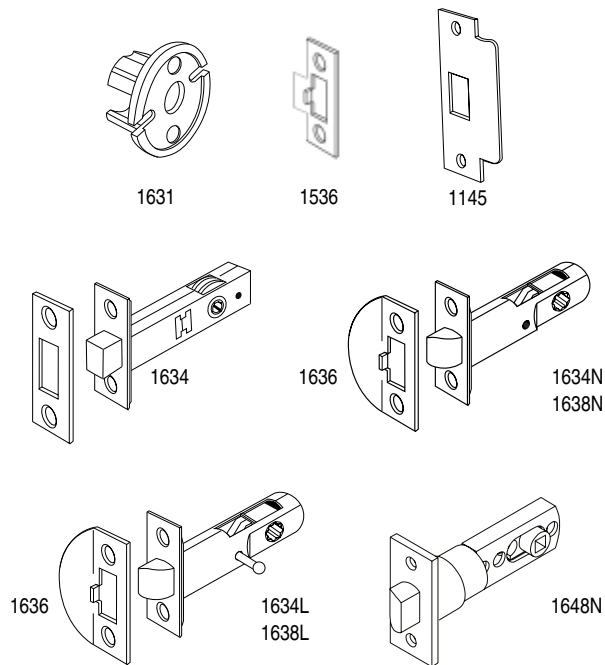

PART #	DESCRIPTION	BACKSET FRONT	FINISH GROUPS		
			NO FINISH	3, 26	10, 10B, 32
1631	Support housing	—	12.56	—	—
1536	"T" Strike, 2-3/4" curved lip	—	—	12.56	20.09
1145	4-7/8" ASA strike	—	—	15.07	27.62
1634	Tubular deadbolt	2-3/4"	—	134.36	143.15
1636	Strike, 2-1/4" full curved lip	—	—	12.56	20.09
1634N	Passage latch w/ strike	2-3/4"	—	95.43	121.80
1634L	Privacy latch w/ strike	1" x 2-1/4"	—	114.27	126.82
1638N	Passage latch w/ strike	2-3/8"	—	61.53	77.85
1638L	Privacy latch w/ strike	1" x 2-1/4"	—	77.85	92.92

Latches & Cylindrical Cartridge

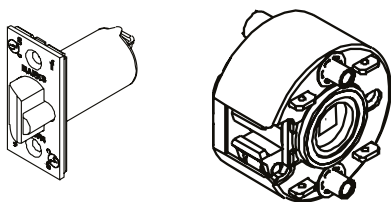

1834

A1430

Cylindrical Cartridge

NOTE: Cylindrical Cartridge is for use with E7* Option ONLY.

LATCH	THROW	Backset 2-3/8"; Front 1" x 2-1/4"	Backset 2-3/4"; Front 1-1/8" x 2-1/4"	FUNCTION	FINISH GROUPS	
					3, 32D	10, 10B
GRADE 2	1/2"	1138A	1134A	ENTRANCE	55.25	41.44
GRADE 1	9/16"	—	1834A	ENTRANCE	115.52	74.08

PART #	DESCRIPTION	NO FINISH
A1430	Cylindrical Cartridge	81.62

How To Order DEFENDER LOCKSETS

How To Order Example for Defender Locksets					
145	K	/	32D	—	D1
<i>1. Lockset Series</i>	<i>2. Marks Function</i>	<i>Slash</i>	<i>3. Finish</i>	<i>Dash</i>	<i>4. Options Specify: Keying, Handing & Door Thickness</i>

1 SERIES	
Defender Tubular Deadbolt Locksets	130, 130R
Defender Cylindrical Cartridge Deadlatch Locksets	145, 145R

2 TUBULAR FUNCTIONS				
DEADBOLT/DEADLATCHES (* indicates IC Core)				
			130 Series	145 Series
K	RK*	CYLINDER x TURNPIECE	E0151	E01101
KK	RKK*	CYLINDER x KNOB		
L	RL*	COMM. SINGLE CYLINDER	E0161	E0131
KL	RKL*	CYLINDER x LEVER		E01101
M	RM*	DOUBLE CYLINDER	E0141	E01111
S	RS*	CLASSROOM	E0171	
X		TURNPIECE	E0191	E01121

3 FINISH		
MARKS		ANSI #
US 3	Polished Brass, Clear Coated	605
US10	Satin Bronze, Clear Coated	612E
US 10B	Dark Bronze, Clear Coated	613E
US 26D	Satin Chrome, Plated	626
US 32	Polished Stainless Steel	629
US 32D	Satin Stainless Steel	630

4 OPTIONS		
TRIM MODIFICATIONS	CODE	PRICE
Tactile knob/lever, coated ext. only	A1	62
Tactile knob/lever, knurled	A4	62
Tactile knob/lever, coated int. & ext.	A18	126
DOOR THICKNESS	CODE	PRICE
50 mm (2")	D1	NC
57 mm (2-1/4")	D2	53
1-1/4" - 1-1/2"	D8	NC
LATCH	CODE	PRICE
2-3/4" backset, 1-1/8" x 2-1/4" face	E4	11
2-3/8" backset, 1-1/8" x 2-1/4" face	E11	13
TRIM CHANGES	CODE	PRICE
Sargent conventional cylinder	F8	23
CYLINDER	CODE	PRICE
Less cylinder	G3	Deduct 16
STRIKE	CODE	PRICE
4-7/8" ASA strike	S1	14
4-7/8" x 1-1/4" security strike	S4	12

Defender Series

DEADBOLT/DEADLATCH FUNCTIONS

ANSI # CODE	MARKS # FUNCTION	ANSI # CODE	MARKS # FUNCTION
130 SERIES:			
E0151 K	E01101 K
E0161 L	E0131 L
E0141 M	E01101 KL
E0171 S	E01111 M
E0191 X	E01121 X

ANSI # CODE	Marks Function	
	I/S	O/S
CYLINDER x TURNPIECE: Deadbolt/deadlatch by inside turnpiece or outside key.		K
COMMUNICATING SINGLE CYLINDER: Deadbolt/deadlatch by key from one side only.		L
CYLINDER x LEVER: Deadlatch by key outside. Inside lever always opens latch.		KL

ANSI # CODE	Marks Function	
	I/S	O/S
DOUBLE CYLINDER: Deadbolt/deadlatch by key either side.		M
CLASSROOM: Deadbolt by outside key. Turnpiece will retract but not project deadbolt.		S
TURNPIECE x BLANK PLATE: Deadbolt/deadlatch by inside turnpiece. Blank plate outside.		X

130 SERIES "DEFENDER" TUBULAR DEADBOLTS

ANSI 156.5				Standard Features	
 <p style="text-align: center;">130K</p>				<ul style="list-style-type: none"> • Bolt: 1" throw • Unitized assemblies for 2-1/8" bore • Strike: #1335, 2-3/4" x 1-1/8" strike • Door thickness: 1-3/8" to 1-7/8" • Cylinder: MARKS "C" keyway, 6 pin w/ 2 keys • 2-3/8" Backset • Latch front: 1" x 2-1/4" 	
MARKS #		FUNCTION	ANSI #	FINISH GROUPS	
COMM. CYL.	IC CORE CYL.*			3, 10, 10B, 32, 32D	
K	RK	CYLINDER x TURNPIECE	E0151	224.83	
L	RL	COMMUNICATING SINGLE CYL	E0161	224.83	
M	RM	DOUBLE CYLINDER	E0141	217.34	
S	RS	CLASSROOM	E0171	195.93	
X	—	TURNPIECE x BLANK PLATE	E0191	157.38	

DEADBOLTS ARE PACKED 24 PER CASE

NOTE: Split designs and/or finishes are priced at the highest design and/or finish • Special finishes, consult factory
• IC Core Models: Core not included

OPTIONS	CODE	PRICE
For 2" door	D1	NC
For 2-1/4" door	D2	53
For 1-1/4" - 1-1/2" door	D8	NC
2-3/4" backset, 1-1/8" x 2-1/4" face	E4	12
For 1-1/2" bore	F6	21
Sargent original cylinder or core	F8	24
Less cylinder	G3	Deduct 16
3-5/8" x 1-1/4" Security strike	S4	12

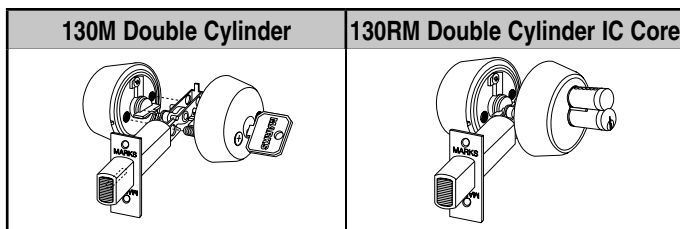

*** Standard IC Core Models:** 

Interchangeable Core models for 6 or 7 pin cores (not included).
Accepts: Marks, Medeco KeyMark™, Falcon & Best®. IC Core Tailpieces ARE Included.

Defender Series

145 SERIES "DEFENDER" CYLINDRICAL CARTRIDGE DEADLATCHES

ANSI 156.5 • 3 Hour Fire Rating		c UL US LISTED		Standard Features	
 <p style="text-align: center;">145M</p>				<ul style="list-style-type: none"> • Series 1 Cylindrical Cartridge • Latch: Grade 1, 9/16" throw, 2-3/4" backset • Unitized assemblies for 2-1/8" bore • Strike: #1136, 2-3/4" strike • Door thickness: 1-3/4"; For 1-3/8" doors use spacer rings K1442/32D • Cylinder: MARKS "C" keyway, 6 pin w/ 2 keys • Latch front: 1-1/8" x 2-1/4" 	
MARKS #		FUNCTION	ANSI #	FINISH GROUPS	
COMM. CYL.	IC CORE CYL.*			3, 10, 10B, 32, 32D	
K	RK	CYLINDER x TURNPIECE	E01101	243.03	
L	RL	COMMUNICATING SINGLE CYL	E0131	243.03	
M	RM	DOUBLE CYLINDER	E01111	263.37	
X	—	TURNPIECE x BLANK PLATE	E01121	206.63	
KL	RKL	CYLINDER x LEVER	E01101	411.12	
KK	RKK	CYLINDER x KNOB		427.18	

DEADLATCHES ARE PACKED 24 PER CASE

NOTE: Split designs and/or finishes are priced at the highest design and/or finish • Special finishes, consult factory
• IC Core Models: Core not included

OPTIONS	CODE	PRICE
For 2" door	D1	NC
For 2-1/4" door	D2	55
2-3/8" backset, 1-1/8" x 2-1/4" face	E11	14
Sargent original cylinder or core	F8	24
Less cylinder	G3	Deduct 16
4-7/8" ASA strike	S1	14

*** Standard IC Core Models:** 

Interchangeable Core models for 6 or 7 pin cores (not included).
Accepts: Marks, Medeco KeyMark™, Falcon & Best®. IC Core Tailpieces ARE Included.

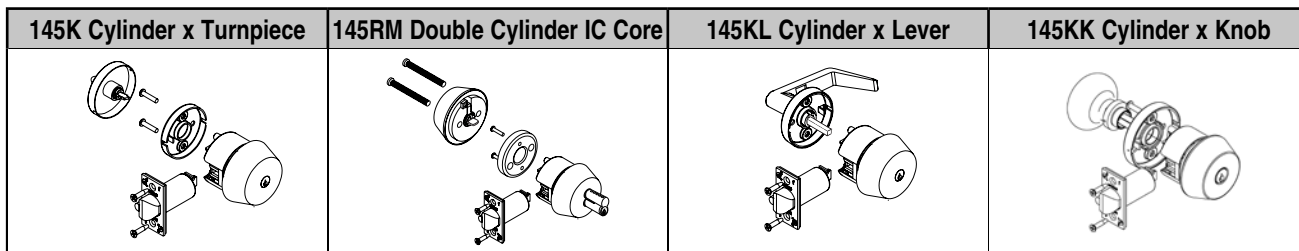

DEFENDER SERIES ACCESSORIES

Strikes, Latches & Spacers

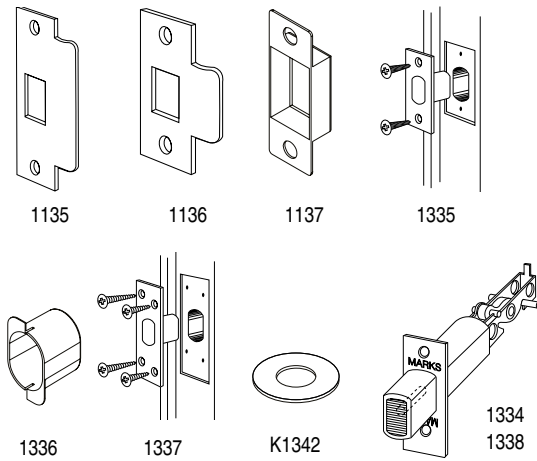

PART #	DESCRIPTION	FINISH GROUPS		
		NO FINISH	3, 32D	10, 10B, 32
1135	4-7/8" ASA STRIKE	—	28.88	28.88
1136	2-3/4" "T" STRIKE W/DUST BOX	—	12.56	18.84
1137	DUST BOX, PLASTIC, LATCH	7.53	—	—
1335	2-3/4" x 1-1/8" STANDARD STRIKE	—	10.05	12.56
1336	DUST BOX, PLASTIC, DEADBOLT	7.53	—	—
1337	3-5/8" x 1-1/4" HIGH SECURITY STEEL STRIKE, PLATED FINISH	—	85.39	—
K1342	1-3/8" DOOR, ROSE EXTENDERS, 130 Series	—	67.81	84.13
DEADBOLTS				
1334	2-3/4" BACKSET FRONT 1-1/8" x 2-1/4"	—	43.95	55.25
1338	2-3/8" BACKSET FRONT 1-1/8" x 2-1/4"	—	43.95	55.25
K1442	1-3/8" DOOR, 145 SERIES	—	194.63	—

Latches & Cylindrical Cartridge

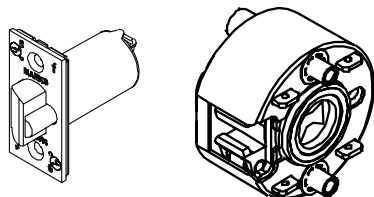

1834

A1420 Cylindrical Cartridge for use with 145 Series

NOTE: Cylindrical Cartridge is for use with E7* Option ONLY.

LATCH	THROW	Backset 2-3/8" Front 1" x 2-1/4"	Backset 2-3/4" Front 1-1/8" x 2-1/4"	FUNCTION	FINISH GROUPS	
					3, 32D	10, 10B
GRADE 2	1/2"	1138A	1134A	ENTRANCE	55.25	69.06
GRADE 1	9/16"	—	1834A	ENTRANCE	115.52	124.31

PART #	DESCRIPTION	NO FINISH
A1420	Cylindrical Cartridge for use with 145 Series	138.12

Tailpieces & Cylinders

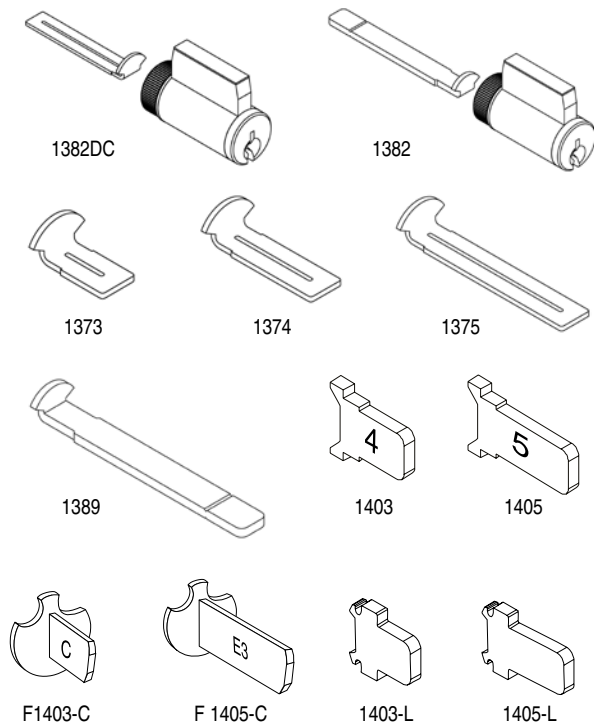







PART #	TAILPIECES FOR 130 DEADBOLTS	PRICE
DOUBLE CYLINDER		
1373	1-5/16" to 1-3/8"	MARKS 1382DC
1374	1-5/8" to 2"	
1375	2-1/8" to 2-3/8"	
SINGLE CYLINDER		
1389	1-3/4" to 2-1/4"	MARKS 1382
TAILPIECES FOR 145 DEADLATCHES		
1403	1-5/8" to 1-7/8"	MARKS TAILPIECE
1405	2" to 2-1/4"	
F1403-C	1-5/8" to 1-7/8"	SCHLAGE® TAILPIECE
F1405-C	2" to 2-1/4"	
1403-L	1-5/8" to 1-7/8"	LORI / ILCO TAILPIECES
1405-L	2" to 2-1/4"	

I-QWIK LITE² SERIES



NO-NONSENSE ACCESS CONTROL RIGHT OUT OF THE BOX

MARKS #		LOCKSET TYPE - PACKED PER CASE	# OF USERS	FINISH GROUPS	
IQ1LITE	IQ1L/26D			19 Black Powder Coat; with 26D American Levers	26D Satin Chrome
		IQ1: Cylindrical Lockset - <i>PACKED 4 PER CASE</i>	160	1126.15	1296.66
		IQ2: Mortise Lockset - <i>PACKED 4 PER CASE</i>	160	11818.09	1988.60
		IQ7: Rim Exit Device Interface - <i>PACKED 6 PER CASE</i> <i>Adapter plates operate most manufacturers Rim Exit Devices.</i> <i>Adapter plates for Mounting Exit Devices are sold separately, see page 70.</i>	160	1580.17	1752.66

Access Control

Standard Features

- **CableGard™** protects wires for easy installation
- Standard ANSI door prep with one additional hole
- Pre-programmed code
- Keypad programmable
- 160 User codes
- Temporary user codes
- Passage mode
- Pin only mode
- Double code entry for maximum security
- Two wire remote release
- 16 Digit tactile metal keypad
- Weatherproof standard
- Audible & visible entry indicator
- Audible low battery alert
- 4 "AA" batteries, 95,000 operations
- Easy installation
- Lifetime Mechanical Warranty; 2 Year Electronic Warranty

IQ1 LITE Cylindrical Lockset Specifications

Door Thickness: 1-3/4" standard;
For thicker doors, Consult factory

Handing: Non-handed

Key Override: Marks "C" keyway, 6 pin w/2 keys, IC Core optional

Lock Body: Cylindrical "Survivor" featuring the "Clutch" for trouble free service

Latch: Grade 2, 2-3/4" backset, 1/2" throw, 3 Hour UL fire rating

Strike Plate: 4-7/8" ASA strike

IQ2 LITE Mortise Lockset Specifications

Door Thickness: 1-3/4" standard;
For thicker doors, Consult factory

Handing: Field reversible

Key Override: 1-1/8" Mortise cylinder, 6 pin w/2 keys

Lock Body: Grade 1, Series 5, 2-3/4" backset, 3/4" anti-friction latch, 3 Hr UL fire rating

Auxiliary Latch: 1/2" throw

Clutch: The "Clutch" for trouble free service

Strike Plate: 4-7/8" ASA standard

IQ7 LITE Rim Exit Device Interface Specifications

Door Thickness: 1-3/4" standard;
For thicker doors, Consult factory

Handing: Non-handed

Key Override: 1-1/8" Mortise cylinder, 6 pin w/2 keys

Clutch: The "Clutch" for trouble free service

Adapter plates operate most manufacturers Rim Exit Devices. Adapter plates for Mounting Exit Devices are sold separately, see page 70.

How To Order Example for i-Qwik LITE Series Electronic Access Control Locksets

IQ	1LITE	
1. Lockset Series	19 Finish	2. Model Number
		26D Finish

IQ

1LITE (Cylindrical)

1L/26D (Cylindrical)

2LITE (Mortise)

2L/26D (Mortise)

7LITE (Rim Exit Device Interface)

7L/26D (Rim Exit Device Interface)

I-QWIK/I-QUE SERIES

OPTIONS



I-QWIK / I-QUE OPTIONS			Cylindrical	Mortise	Rim Exit Device Interface
DESCRIPTION	CODE	PRICE	IQLITE	IQLITE	IQLITE
Backset					
2-3/8" Backset	E6	NC	•		
5" Backset	E9	48	•		
3-3/4" Backset	E10	48	•		
Series 55 Mortise Lock Body (2-1/2" bkst)	W8	NC		•	
Levers					
Tactile Lever	A1	62	•	•	•
Lever to accept Sargent conventional cyl.	F8	24	•		
Lever to accept Corbin conventional cyl.	F9	24	•		
Lever to accept Corbin IC Core 6 pin	F12	35	•		
Lever to accept Corbin IC Core 7 pin	F13	35	•		
Lever to accept Yale IC Core 6 pin	F14	24	•		
Lever to accept Yale IC Core 7 pin	F15	24	•		
Lever to accept Sargent IC Core	F20	23	•		
Lever to accept Medeco IC Core lg. format	F21	24	•		
Solid Exterior Handle (no cylinder)	W4	NC	•	Std	Std
Crescent Lever	W7	21	•	•	•
Titan Lever	W12	21	•	•	•
Cylinder					
IC Core Cylinder Housing	G1	NC	•	•	•
Less Cylinder	G3	Deduct 16	•	•	•
Strike					
4-7/8" ASA Strike	S1	14	•	Std	
2-3/4" "T" Strike	S3	NC	Std		
Miscellaneous					
Tamper-proof Screws	A3	15	•	•	•







Access Control

IQWIK LITE ACCESSORIES

I-QWIK / I-QUE ACCESSORIES			Cylindrical	Mortise	Rim Exit Device Interface
ACCESSORY	PART #	PRICE			
Bridge Rectifier (converts AC power to DC power)	1901	52.74	•	•	•
Gasket (interior inside housing for full weatherproofing)	E1108	10.05	•	•	
Battery Pack Holder	EA4011	26.37	•	•	•
Spacer Kit, 1-3/8" Door (Int. & Ext. Gaskets)	EK1038	77.85	•	•	•
Internal power connector for hardwiring i-Qwik/i-Que Locksets	E1133	37.67	•	•	•
Memory Reset Jumper	E1155	26.37	•	•	•
Spacer Ring for 1-1/4" mortise cylinder	E2006	26.37		•	•
Spacer Ring for 1-3/8" mortise cylinder	E2007	26.37		•	•
Rim Exit Device Adaptor Plate					
Von Duprin 99 Rim Adapter Plate / M9900 Marks Detex Advantex 10 Series Rim Adapter Plate	E7071	100.45			•
Precision 1100 Rim Adapter Plate	E7072	100.45			•
Yale 7100 Rim Adapter Plate/ Corbin ED5200 Rim Adapter Plate	E7073	100.45			•
Dorma 9300 Rim Adapter Plate	E7074	100.45			•
Sargent 8800 Rim Adapter Plate/ Arrow 3800 Rim Adapter Plate	E7075	100.45			•
Precision 21 Rim Adapter Plate/ Precision 2100 Rim Adapter Plate**	E7076	100.45			•
Von Duprin 88 - Special Order, Consult Factory	E7077	100.45			•
Monarch 18R Exit Device Adapter Plate	E7078	114.27			•

NOTE: Consult Factory for Additional Exit Devices; **Must use Precision #BP21 backplate.

TAILPIECES & CAMS

CYLINDRICAL TAILPIECES Cylindrical Conventional				
	FOR USE WITH	LEVER	CODE	PRICE
	Marks 1982	E1903	E1	8.35
	Arrow PK 100C, ILCO 705, Sargent 13-3266, Lori 1539, ASSA 65673, 65691, Abloy	E1903-L	E2	8.35
	Schlage® 23-001, Primus Corbin-Russwin 2000-034	EF1903-C	E3	8.35
CYLINDRICAL IC CORES				
	Kit for 6 & 7 pin Marks, KSP, Best®, Falcon, Medeco® Keymark, Schlage® Small Format, 6 pin Sargent	HER1984	ER	8.35
	Kit for 6 & 7 pin Corbin	HER1984-G	ERG	8.35
	Kit for 6 & 7 pin Yale™ American Lever ONLY	EAR1989-Y	EMY	10.76
	6 pin Schlage® Large Format American Lever ONLY	EF1903-F19	CM	10.76

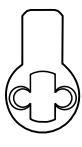
CAMS				
Straight cam for tubular, exit device, or mortise functions Z1 & Z4 only.				
	USE WITH MORTISE CYLINDER	PART #	CODE	PRICE
	MARKS	2101	1	8.35
	Arrow/Sargent	2101-A	A1	8.35
	Corbin Russwin	2101-C	C1	8.35
	Schlage®	2101-S	S1	8.35
	2101 Straight Cam			

REQUEST TO EXIT (REX) CYLINDRICAL ELECTRIFIED LEVERSET

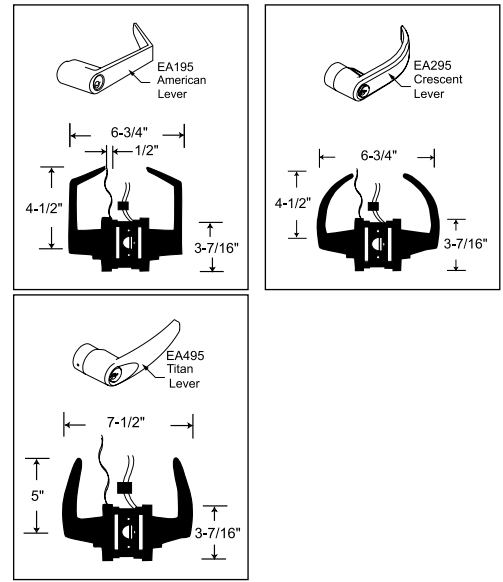

 **ANSI-A156.2 • Grade 1
3 Hour Fire Rating**

EA195 Series Leverset w/American Lever



Marks USA has developed the Grade 1 "Survivor" Series Cylindrical Lockset incorporating a Request to Exit (REX) switch in both **Electrified** and **Storeroom** functions. Activating the inside lever for egress initiates the built-in **REX** output, providing a momentary signal for the access control **REX** input, for alarm shunt during egress.

Standard Features		
<ul style="list-style-type: none"> Backsets: 2-3/4"; 2-3/8", 3-3/4" or 5" optional Latch #1834, Front: 1-1/8" x 2-1/4"; Throw: 9/16"; Stainless steel nose Levers: Solid cast Zamac w/ 1/2" return (except 395 & 495) 	<ul style="list-style-type: none"> Rose: Thru-bolted, 3-7/16" dia., spring loaded 2-#10 thru-bolts Strike: #1135, 4-7/8" ASA curved lip Door thickness: 1-5/8" to 1-7/8" (For 1-3/8" door use K1704 spacer) Cylinder: MARKS "C" keyway, 6 pin w/ 2 keys 	<ul style="list-style-type: none"> Request to Exit Switch: Single pole, double throw, 3 amp, 125 AC, wired either normally open or normally closed Electrified functions - 100% duty cycle, 24V/DC standard, supplied with bridge rectifier; 3 watts, .25amps 12V/DC Optional, Contact factory for additional options Features "The Clutch" • UL Listed, 3 hour fire rating

LOCKSET & LEVER DESIGN	CON. CORE	IC CORE	FUNCTION	ANSI #	DESCRIPTION	FINISH GROUPS	
						26D	3, 4, 10, 10B, 26
EA195 American lever	F	RF	STOREROOM	F86	Latch by lever inside. Outside lever always locked.	680.92	772.99
EA295 Crescent lever							
EA395 Monaco lever							
EA495 Titan lever							
EA195 American lever	FEL	RFEL	ELECTRICALLY LOCKED	—	Outside always locked electrically. Open by key outside, switch or loss of power. Latch by lever inside.	934.66	1005.32
EA295 Crescent lever							
EA395 Monaco lever							
EA495 Titan lever							
EA195 American lever	FEU	RFEU	ELECTRICALLY UNLOCKED	—	Outside always locked until unlocked by key or electrically energized. Latch by lever inside.	934.66	1005.32
EA295 Crescent lever							
EA395 Monaco lever							
EA495 Titan lever							

LEVERSETS ARE PACKED 6 PER CASE

* Standard IC Core Models: Accepts: Marks, Medeco KeyMark™, Interchangeable Core models Falcon & Best®, for 6 or 7 pin cores (not included). IC Core Tailpieces ARE Included.



How To Order Example for REX Leversets

EA195	F	/	26D	—	G3
1. Lockset Series	2. Marks Function	Slash	3. Finish	Dash	4. Options
LOCK SERIES <input type="checkbox"/> EA195 <input type="checkbox"/> EA295 <input type="checkbox"/> EA395 <input type="checkbox"/> EA495	MARKS FUNCTION ___ F ___ RFEL ___ RF ___ FEU ___ FEL ___ RFEU		FINISH <input type="checkbox"/> 3 <input type="checkbox"/> 4 <input type="checkbox"/> 10 <input type="checkbox"/> 10B <input type="checkbox"/> 26 <input type="checkbox"/> 26D		OPTIONS _____ _____ _____

Electrified Locksets

LECTRA ELECTRIFIED LOCKSETS



CYLINDRICAL LEVERSETS & MORTISE LOCKSETS

	ANSI-A156.2 • Grade 1 3 Hour Fire Rating		 195 American Lever	 295 Crescent Lever	 495 Titan Lever
195FEL/FEU Series Leverset w/American Lever					

Series 195, 295, 395, 495 Cylindrical Leverset Standard Features

- Backsets: 2-3/4", 2-3/8", 3-3/4", 5"
- Latch #1834, Front: 1-1/8" x 2-1/4"; Throw: 9/16"; Stainless steel nose
- Levers: Solid cast Zamac w/ 1/2" return
- Rose: Thru-bolted, 3-7/16" dia., spring loaded 2-#10 thru-bolts
- Strike: #1135, 4-7/8" ASA curved lip
- Door thickness: 1-5/8" to 1-7/8" (For 1-3/8" door use K1904 spacer)
- Cylinder: MARKS "C" keyway, 6 pin w/ 2 keys or IC Core housing
- Electrified functions - 100% duty cycle, 24V/AC supplied with bridge rectifier; 24V/DC, .21 Amps
- 12V/DC Optional, Contact factory for additional options
- Features "The Clutch"
- UL Listed, 3 hour fire rating

SERIES 195, 295, 395, 495 GRADE 1 ELECTRIFIED CYLINDRICAL LEVERSETS				FINISH GROUPS	
COMMERCIAL CYLINDER	IC CORE CYLINDER	MARKS FUNCTION	DESCRIPTION	3, 26D	4, 10, 10B, 26
FEL	RFEL	ELECTRICALLY LOCKED (Fail Safe)	Outside always locked electrically. Open by key outside, switch or loss of power. Deadlocking latch by lever inside. Lever only.	 722.56	 813.93
FEU	RFEU	ELECTRICALLY UNLOCKED (Fail Secure)	Outside always locked until unlocked by key or electrically energized. Deadlocking latch by lever inside. Lever only.		

* Standard IC Core Models: Accepts: Marks, Medeco KeyMark™, Interchangeable Core models Falcon & Best®. for 6 or 7 pin cores (not included). IC Core Tailpieces ARE Included.

Electrified Locksets

Series 5 Electrified Mortise Lockset Standard Features

- 2-3/4" Backset ONLY
- 1" Stainless steel bolt throw
- 3/4" Latch throw (anti-friction) separator
- 1/2" Auxiliary latch throw
- Stamped steel case .090 thick., Zinc dichromate finish
- 1-1/4" x 8" Lock front, Adjustable bevel
- Steel hubs, 9/32" on diamond, 5/16" on square w/security separator
- 100% Duty Cycle 24V/DC, 12V/DC supplied with bridge rectifier (350 ma)

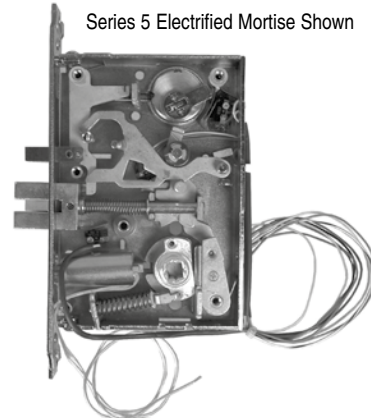

OPTIONS	CODE	PRICE
Auxiliary Latch	E3	47
Request to EXit Switch	W10	140
Key Override Sensor	W11	148
Request to EXit switch, Key Sensor & Bolt Sensor	W13	468
Bolt Sensor	W14	171
Latch Sensor	W15	171

SERIES 5 ELECTRIFIED MORTISE LOCKSET			FINISH GROUPS	
MARKS FUNCTION	DESCRIPTION	3, 32D	10, 10B, 32	
EL: ELECTRICALLY LOCKED (Fail Safe)	Outside always locked electrically. Open by key outside, switch or loss of power. Auxiliary latch deadlocks latch. Inside always open.	 941.01*	 963.07*	
EU: ELECTRICALLY UNLOCKED (Fail Secure)	Outside always locked until unlocked by key or electrically energized. Auxiliary latch deadlocks latch. Inside always open.			

* Lock Body Price ONLY. Due to numerous trim and finish options, please refer to the Marks USA Mortise Lockset Price Book.

GATE LOCKS (Reversible)

US PAT.#4,875,725 "NO FALL OUT" FEATURE:
Parts will not fall out when cover is removed.
Replaces Multilock gate locks.

Swinging Gate Locks

Standard Features

- Easily reversible
- Case, cast aluminum 3-5/8" x 6-1/4" x 1"
- Bronze powder coat finish
- Groove: 1/2" wide x 3/16" deep, all sides for wire gate insertion
- 5 pin cylinder(s)
- Lock only, no keeper furnished

Single
Cylinder Model
*With cylinder
Suffix K
Add \$31

Double
Cylinder Model
*With cylinders
Suffix M
Add \$63

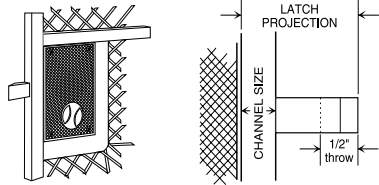

MODEL #	LATCH PROJECTION	CHANNEL SIZE	PRICE LESS CYL.*	WT. / LBS.
W3700	1-1/8"	1/2"	161.67	20
W3710	1-1/4"	5/8"	161.67	20
W3720	1-3/8"	3/4"	161.67	20
W3730	1-7/8"	1-1/4"	182.01	20
W3750	1-1/8"	1/2"	228.04	21
W3760	1-1/4"	5/8"	228.04	21
W3770	1-3/8"	3/4"	228.04	21
W3780	1-7/8"	1-1/4"	251.60	21

GATE LOCKS ARE PACKED 12 PER CASE

Sliding Gate Locks

Standard Features

- Easily reversible
- Case, cast aluminum 3-5/8" x 6-1/4" x 1"
- Bronze powder coat finish
- Groove: 1/2" wide x 3/16" deep, all sides for wire gate insertion
- 5 pin cylinder(s)
- Lock only, no keeper furnished

Single
Cylinder Model
*With cylinder
Suffix K
Add \$31

Double
Cylinder Model
*With cylinders
Suffix M
Add \$63

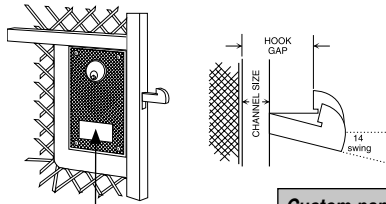

Custom nameplate available.
Consult factory.

MODEL #	HOOK GAP	CHANNEL SIZE	PRICE LESS CYL.*	WT. / LBS.
W3800	.825"	1/2"	161.67	21
W3810	.950"	5/8"	161.67	22
W3820	1.075"	3/4"	161.67	21
W3830	1.625"	1-1/4"	182.01	22
W3850	.825"	1/2"	228.04	22
W3860	.950"	5/8"	228.04	22
W3870	1.075"	3/4"	228.04	22
W3880	1.625"	1-1/4"	251.60	22

GATE LOCKS ARE PACKED 12 PER CASE

Parts

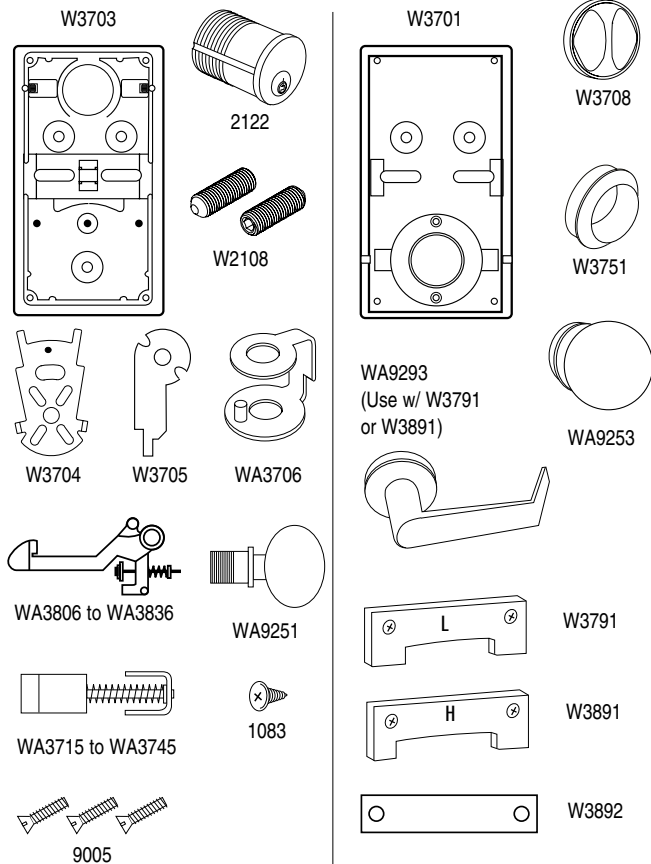

PART #	DESCRIPTION	PRICE
1083	Retainer/fork screw	.78
2122	Mortise cylinder	55.25
W2108	Cylinder set screw	.78
9005	Case screw	.78
W3701	Cover	55.25
W3703	Case	86.64
W3704	Fork	11.30
W3705	Latch lever	10.05
W3708	Turnpiece	28.88
W3751	Double cylinder collar with set screw	55.25
W3791	Lever stop plate - Swinging gate lock (w/W3892)	18.84
W3891	Lever stop plate - Sliding gate lock (w/W3892)	18.84
W3892	Lever slide cover	7.53
WA3706	Latch adapter	18.84
WA3715	Latch assembly - 1-1/8" projection	41.44
WA3725	Latch assembly - 1-1/4" projection	41.44
WA3735	Latch assembly - 1-3/8" projection	41.44
WA3745	Latch assembly - 1-7/8" projection	55.25
WA3806	Hook assembly - .825" gap	55.25
WA3816	Hook assembly - .950" gap	55.25
WA3826	Hook assembly - 1.075" gap	55.25
WA3836	Hook assembly - 1.625" gap	69.06
WA9251	Exterior knob assembly	113.01
WA9253	Interior knob assembly	113.01
WA9293	Interior lever assembly (with W3791 & W3891)	167.00

SERIES HA113 CUSTOM LOCK DIVISION

HOUSING AUTHORITY MORTISE LOCKSET

Custom Locksets

SERIES HA113			BHMA CERTIFIED
			FINISH GROUPS
MARKS #	FUNCTION	ANSI #	20A
KEYED SINGLE CYLINDER, NO DEADBOLT			
D	OFFICE VESTIBULE		618.82
DW	VESTIBULE		
E	OFFICE	F04	
EW	STOREROOM	F07	
GL	INST. PRIVACY	F26	
J	CLASSROOM	F05	
JM, JR	HOSPITAL (HOLDBACK)	F06	
EL	ELECTRICALLY LOCKED		1233.37
EU	ELECTRICALLY UNLOCKED		
KEYED SINGLE CYLINDER, WITH DEADBOLT			
A	ENTRANCE	F08, F10	634.88
B	ENTRANCE	F21	
F	DORMITORY	F12	
FS	DORMITORY		
FW	DORMITORY	F13	
FD	APARTMENT	F20	680.92
H	HOTEL	F15	
LH	SPEC. PRIVACY		
KEYED DOUBLE CYLINDER, NO DEADBOLT			
G	ENTRANCE	F09	680.92
GC	INTRUDER LATCHBOLT	F32	
GG	CLASSROOM SECURITY		
GR	CLASSROOM SECURITY w/HOLDBACK		
WW	INSTITUTION	F30	
KEYED DOUBLE CYLINDER, WITH DEADBOLT			
AC	ENTRANCE	F35	680.92
C	STOREROOM	F14	
FC	INTRUDER DEADBOLT	F34	
FA	DORMITORY	F11	
FX	DORMITORY	F33	
KEYLESS			
N	PASSAGE	F01	540.67
L	BATHROOM	F02	598.48
LF	PRIVACY	F19	
LJ	PRIVACY	F22	657.37
EX	EXIT	F31	618.82
For pricing, finishes and availability, consult factory			

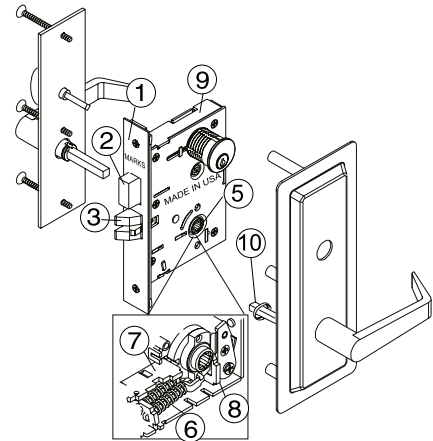

Performance Specifications:

Life Test: 1,500,000 cycles minimum.

ANSI Test: Meets or exceeds all operational and security tests of ANSI specifications A156.13-2005 for series 1000, Grade 1.

Fire Test: UL Listed, 3 hour fire rated.
Meets ADA requirements.



Trim Specifications:

"Barrier" Thru-bolted steel lever/plate assemblies with brass machined lever bearings. Screwless forged American levers, 4-1/2" long to meet ADA requirements, fastened to plates with hardened snap rings. Spring loaded 5/16" spindles (no set screws). Dark bronze powder coated finish.

Exterior: Wrought steel lever/plate assembly.

10-1/8" x 4" x 5/64" with 3 concealed welded thru-posts. Center post braces lock body for proper alignment in 1-3/4" thick door. Plate covers cylinder with only the keyway exposed.

Optional Exterior: Plate prepared for IC core cylinder.

Interior: Flat steel lever/plate assembly. 10-3/4" x 3-1/8" x 3/32" thick with 3 each 1/4"-20 mounting bolts. Center bolt passes through lock body to integrate trim with lock.

Cylinder: 1-1/8" long, 6 pin, solid brass with spacing collar concealed under exterior "Barrier" plate; 2 keys.

Strike: 4-7/8" x 1-1/4" x 3/32" thick, 5/8" curved lip. Conforms to ANSI spec., A115.1.

Door Thickness: 1-3/4" standard. Extended range available.

Lock Specifications: 5 Series (2-3/4" Backset)

1. Lock Front: Adjustable bevel steel backplate 1-1/4" x 8" x 7/64" thick. Cover plate 1/16" thick.

2. Deadbolt: Stainless steel w/hardened roll pins, 1" throw.

3. Latch: Solid stainless steel with antifriction latch lever, 3/4" throw (reversible).

4. Auxiliary deadlatch: 1/2" throw (reversible) - (not shown).

5. Hubs: Steel, 9/32" on diamond, 5/16" on square w/security separator.

6. Independent exterior and interior lever support springs.

7. Hub Follower: (to lock hub) steel 1/8" thick.

8. Hub Stop: (to limit lever travel) steel 1/8" thick.

9. Case: Stamped steel 3/32" thick, zinc dichromate finish.

10. Spindles: Independent spring-loaded spindles, 5/16" square.

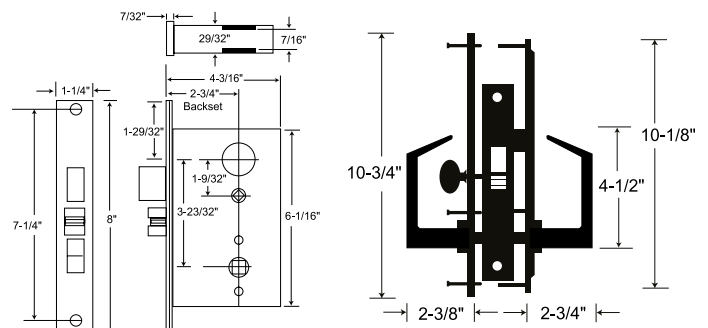

CUSTOM LOCK DIVISION

MAXIMUM SECURITY MORTISE LOCKSET

Series LA318GJ

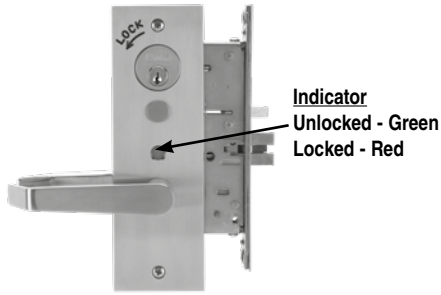

PERFORMANCE SPECIFICATIONS:

LIFE TEST: 1,500,000 cycles, minimum

STRENGTH TEST: 530 inch lbs. torque on exterior lever. When applied, lockset remains locked. (Torque of over 550 inch lbs. will cause spindle failure. However, lockset remains locked once spindle is replaced, lockset is fully operational.)

ANSI TEST: Certified to meet or exceed all operational and security tests of ANSI/BHMA A156.13-2012 for series 1000, Grade 1

FIRE TEST: UL listed, 3 hour fire rated. Meets ADA requirements.

WARRANTY: Lifetime mechanical limited warranty

All other functions available with latch, deadlatch and deadbolt combinations



FUNCTION SPECIFICATION: LA318GJ CLASSROOM INTRUDER

Latch by lever either side except when outside lever is locked from inside or outside by key. When locked, exterior key will retract latchbolt. Outside key locks or unlocks exterior lever. Inside key is single acting in one direction and will lock exterior lever only; will not unlock exterior lever. Auxiliary latch deadlocks latch. Inside always free for egress

TRIM: Cast satin stainless steel escutcheon 8-1/2"x2-3/4"x7/16". Recess in escutcheon to accept cylinder with rotating security cylinder ring. Cast screwless satin stainless steel lever handles to within 1/2" from face of door secured to escutcheon plate with hardened steel retainer ring. Lever handle, with spring-loaded torque sensitive 5/16" spindle. Integral torque override preventer recessed into escutcheon plate. Spindle will yield if excessive torque applied, preventing any damage to lock body.

EXTERIOR: Two 1/4" diameter threaded thru posts.

Two 1/4" diameter center posts pass thru lock body, automatically aligning trim.

INTERIOR: Two #10-32 phillips head stainless steel mounting thru bolts. Escutcheon with "LOCK" and directional arrow engraved and black filled near cylinder location. Occupancy indicator recessed into escutcheon plate. Indicator window to display unlocked (green day-glo) and LocDown™ (red day-glo) positions.

CYLINDERS: Two 1-1/8", 6-pin solid brass with 2101 cam int., 2105 cam ext., with two keys. Outside cylinder rotates in both directions. Inside cylinder rotates in one direction only. Cams supplied to accommodate Corbin™, Sargent™ and Schlage™ cylinders.

STRIKE: 4-7/8" X 1-1/4" X 3/32" thick, 5/8" curved lip.

Conforms to ANSI spec. 115.1.

DOOR THICKNESS: 1-3/4"

Lock Body: 5 series "GJ" function double cylinder lock. Lock handing completely reversible without opening lock case.

1. Lock Front – Adjustable bevel steel backplate 1 1/4" x 8 x 7/64" thick. Cover plate 1/16" thick, with philips screws
2. Latch – solid stainless steel w/ antifriction latch lever 3/4" throw
3. Auxiliary Deadlatch – 1/2" throw
4. Case – stamped steel 3/32" thick
5. Hubs – Steel, 9/32" on diamond, 5/16" on square w/ security separator
6. Independent exterior and interior lever support springs

LA318			FINISH GROUPS
MARKS #	FUNCTION	ANSI #	32D
KEYED SINGLE CYLINDER, NO DEADBOLT			
D	OFFICE VESTIBULE		915.39
DW	VESTIBULE		
E	OFFICE	F04	
EW	STOREROOM	F07	
GL	INST. PRIVACY	F26	
J	CLASSROOM	F05	1260.13
JM, JR	HOSPITAL (HOLDBACK)	F06	
EL	ELECTRICALLY LOCKED		
EU	ELECTRICALLY UNLOCKED		
KEYED SINGLE CYLINDER, WITH DEADBOLT			
A	ENTRANCE	F08, F10	930.38
B	ENTRANCE	F21	
F	DORMITORY	F12	
FS	DORMITORY		
FW	DORMITORY	F13	
FD	APARTMENT	F20	955.00
H	HOTEL	F15	
LH	SPEC. PRIVACY		
KEYED DOUBLE CYLINDER, NO DEADBOLT			
G	ENTRANCE	F09	965.71
GC	INTRUDER LATCHBOLT	F32	
GG	CLASSROOM SECURITY		
GR	CLASSROOM SECURITY w/HOLDBACK		
WW	INSTITUTION	F30	992.47
GJ	CLASSROOM SECURITY		
KEYED DOUBLE CYLINDER, WITH DEADBOLT			
AC	ENTRANCE	F35	981.77
C	STOREROOM	F14	
FC	INTRUDER DEADBOLT	F34	
FA	DORMITORY	F11	
FX	DORMITORY	F33	
KEYLESS			
N	PASSAGE	F01	965.71
L	BATHROOM	F02	808.33
LF	PRIVACY	F19	
LJ	PRIVACY	F22	930.38
EX	EXIT	F31	870.42
DUMMY TRIM			
DI, DO	DUMMY TRIM INSIDE/OUTSIDE		411.12
DT	DUMMY TRIM		823.31

For pricing, finishes and availability, consult factory

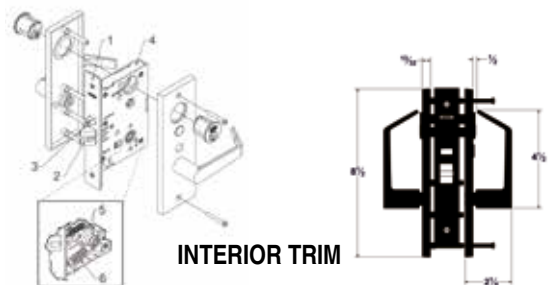

INTERIOR TRIM

SERIES BE101 & LA118 CUSTOM LOCK DIVISION

MAXIMUM SECURITY MORTISE LOCKSET

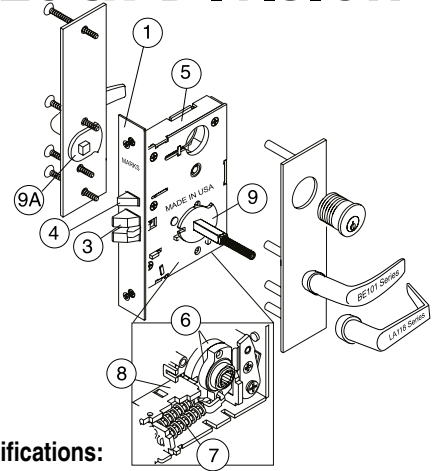

Performance Specifications:

Life Test: 1,500,000 cycles minimum.

ANSI Test: Meets or exceeds all operational and security tests of ANSI specifications A156.13-2005 for series 1000, Grade 1.

Fire Test: UL Listed, 3 hour fire rated.

Meets ADA requirements.



Trim Specifications:

"Barrier" Thru-bolted steel lever/plate assemblies with brass machined lever bearings. Screwless forged American levers, 4-1/2" long to meet ADA requirements, fastened to plates with hardened snap rings. Spring loaded 5/16" spindles (no set screws). Dark bronze powder coated finish.

Exterior: Wrought steel lever/plate assembly.

10-1/8" x 4" x 5/64" with 3 concealed welded thru-posts. Center post braces lock body for proper alignment in 1-3/4" thick door. Plate covers cylinder with only the keyway exposed.

Optional Exterior: Plate prepared for IC core cylinder.

Interior: Flat steel lever/plate assembly. 10-3/4" x 3-1/8" x 3/32" thick with 3 each 1/4"-20 mounting bolts. Center bolt passes through lock body to integrate trim with lock.

Cylinder: 1-1/8" long, 6 pin, solid brass with spacing collar concealed under exterior "Barrier" plate; 2 keys.

Strike: 4-7/8" x 1-1/4" x 3/32" thick, 5/8" curved lip. Conforms to ANSI spec., A115.1.

Door Thickness: 1-3/4" standard. Extended range available.

Lock Specifications: 5 Series (2-3/4" Backset)

- Lock Front:** Adjustable bevel steel backplate 1-1/4" x 8" x 7/64" thick. Cover plate 1/16" thick.
- Deadbolt:** Stainless steel w/hardened roll pins, 1" throw.
- Latch:** Solid stainless steel with antifriction latch lever, 3/4" throw (reversible).
- Auxiliary deadlatch:** 1/2" throw (reversible) - (not shown).
- Hubs:** Steel, 9/32" on diamond, 5/16" on square w/security separator.
- Independent exterior and interior lever support springs.
- Hub Follower:** (to lock hub) steel 1/8" thick.
- Hub Stop:** (to limit lever travel) steel 1/8" thick.
- Case:** Stamped steel 3/32" thick, zinc dichromate finish.
- Spindles:** Independent spring-loaded spindles, 5/16" square.

SERIES BE101 & LA118			BHMA CERTIFIED	
			FINISH GROUPS	
MARKS #	FUNCTION	ANSI #	32D	3, 10, 10B
KEYED SINGLE CYLINDER, NO DEADBOLT				
D	OFFICE VESTIBULE			
DW	VESTIBULE			
E	OFFICE	F04		
EW	STOREROOM	F07	859.72	897.19
GL	INST. PRIVACY	F26		
J	CLASSROOM	F05		
JM, JR	HOSPITAL (HOLDBACK)	F06		
EL	ELECTRICALLY LOCKED			
EU	ELECTRICALLY UNLOCKED		1222.66	1315.80
KEYED SINGLE CYLINDER, WITH DEADBOLT				
A	ENTRANCE	F08, F10		
B	ENTRANCE	F21		
F	DORMITORY	F12	875.77	915.39
FS	DORMITORY			
FW	DORMITORY	F13		
FD	APARTMENT	F20		
H	HOTEL	F15	901.47	941.08
LH	SPEC. PRIVACY			
KEYED DOUBLE CYLINDER, NO DEADBOLT				
G	ENTRANCE	F09		
GC	INTRUDER LATCHBOLT	F32		
GG	CLASSROOM SECURITY		913.25	949.65
GR	CLASSROOM SECURITY w/HOLDBACK			
WW	INSTITUTION	F30		
KEYED DOUBLE CYLINDER, WITH DEADBOLT				
AC	ENTRANCE	F35		
C	STOREROOM	F14		
FC	INTRUDER DEADBOLT	F34	913.25	949.65
FA	DORMITORY	F11		
FX	DORMITORY	F33		
KEYLESS				
N	PASSAGE	F01	746.23	782.63
L	BATHROOM	F02	875.77	915.39
LF	PRIVACY	F19		
LJ	PRIVACY	F22	810.47	849.01
EX	EXIT	F31	810.47	849.01
DUMMY TRIM				
DI, DO	DUMMY TRIM INSIDE/OUTSIDE		376.86	396.13
DT	DUMMY TRIM		754.79	849.01
For pricing, finishes and availability, consult factory				
OPTIONS			CODE	PRICE
BE 1-1/2" thick for adapter plate			A19	80
Spacer kit for 1-1/2" thick door			K9311	780
<i>2 Spacer kits are needed</i>				

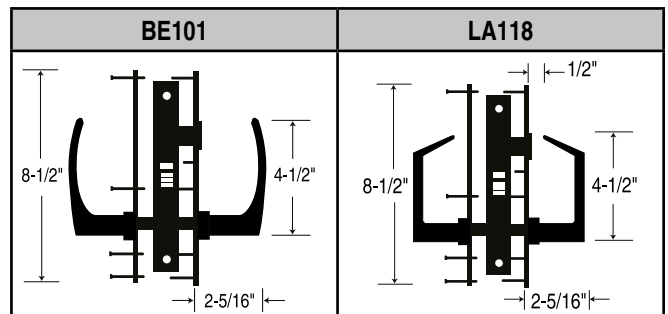

Custom Locksets

GRADE 1 195BH LifeSaver™ D-LIG SLIDE CYLINDRICAL LOCKSETS

		ANSI-A156.2 • Grade 1 3 Hour Fire Rating		195BH SERIES
195SS Series Leversets Shown Below			Standard Features	
			<ul style="list-style-type: none"> • Rating: ANSI A156.2 Grade 1, UL Listed 3Hr Fire Rating • 5- Point Ligature Resistant slide Trim • Backset: 2 3/4" Standard, 2 3/8", 3 3/4" and 5" available • Latch: #1834, stainless Steel Nose • Ergonomic solid cast Stainless Steel Slide, Slides down freely in the locked or unlocked position • Escutcheon Plate solid cast Stainless Steel thru bolted for strength and easy installation • Designed to meet BHMA 156.34 Anti Ligature Trim Standard • Tamper Resistant mounting screws • Strike: #1135, 4 7/8" ASA curved lip Strike • Door Thickness: 1 3/4" • Cylinder: Marks C Keyway, 6 pin w/2 keys – Available in IC and All OEM cylinder preps • Marks Hi-Security Cylinder available • Marks Stainless Steel Retractor - Long life 3X the BHMA Grade 1 cycle Standard • Antimicrobial Finish available – Code AM • Marks Lifetime Mechanical Warranty • Available in Most BHMA ANSI Functions 	

SERIES 195BH					
MARKS #		DESCRIPTION	ANSI #	FINISH	PRICE
COMM. CYL.	ACCEPTS IC CORE CYL.*				
N	—	PASSAGE	F75	32D	1287.47
L	—	PRIVACY	F76		1309.87
B	RB	ENTRY	F82A		1455.41
S	RS	CLASSROOM	F84		1455.41
F	RF	STOREROOM	F86		1455.41
DW	RDW	INSTITUTION	F87		1623.34
DB	RDB	CLASSROOM INTRUDER	F110		1567.36
DO	—	DUMMY TRIM OUTSIDE	—		1231.50
DT	—	FULL DUMMY TRIM	—		615.75
NB	—	COMM. PASSAGE	F111		1253.89
FB	RFB	COMM. STOREROOM	F112		1332.26
SB	RSB	COMM. CLASSROOM	F113		1332.26
FEL	RFEL	ELECTRICALLY LOCKED			1623.34
FEU	RFEU	ELECTRICALLY UNLOCKED			1623.34
PACKED 6 PER CASE					

OPTIONS	CODE	PRICE	OPTIONS	CODE	PRICE
For 2" doors	D1	50	Sargent conventional cylinder	F8	24
For 2-1/4" doors, Consult Factory	D2		Corbin conventional cylinder	F9	24
Over 2-1/4" - 4" thickness	D9	667	Corbin 6 pin IC core	F12	35
2-3/8" backset, 1" x 2-1/4" face	E6	NC	Yale 6 pin IC core	F14	24
5" backset, 9/16" throw, Gr. 1	E9	48	Sargent IC core	F20	24
3-3/4" backset, 9/16" throw, Gr. 1	E10	48	Medeco IC core large format	F21	24
Less cylinder	G3	Deduct 16	Schlage Large Format IC Core	F19	24
2-3/4" "T" strike	S3	NC	7-Pin Yale IC Core	F15	24

How To Order					
195BH	F	/	32D	—	G3
1. Lockset Series	2. Marks Function	Slash	3. Finish	Dash	4. Options



★ **Standard & HI-SECURITY™ IC Core Models:** Interchangeable Core models for 6 or 7 pin cores (not included). **Accepts:** Marks, Marks HI-SECURITY™, Medeco®, KeyMark™, Falcon, Schlage® small format & Best®. **IC Core Tailpieces ARE Included.**



**Antimicrobial Finish Available
Option Code: AM**

Institutional Life Safety

GRADE 1 SERIES 5BH D-LIG SLIDE MORTISE LOCKSET

INSTITUTIONAL LifeSaver™ MORTISE LOCKSETS

BHMA CERTIFIED		C UL US LISTED		FINISH 32D
SERIES 5				
MARKS #	FUNCTION	ANSI #	5BH	
KEYED SINGLE CYLINDER, NO DEADBOLT				
D	OFFICE VEST.		1903.23	
DW	VESTIBULE			
E	OFFICE	F04		
EW	STOREROOM	F07		
J	CLASSROOM	F05		
GL	INSTIT. PRIVACY	F26		
EL	ELECTRICALLY LOCKED		2272.68	
EU	ELECTRICALLY UNLOCKED			
KEYED SINGLE CYLINDER, WITH DEADBOLT				
A	ENTRANCE	F08, F10	1918.90	
B	ENTRANCE	F21		
F	DORMITORY	F12		
FS	DORMITORY			
FW	DORMITORY	F13		
KEYED DOUBLE CYLINDER, NO DEADBOLT				
G	APARTMENT	F09	1954.73	
GC	INTRUDER LATCHBOLT	F32		
GG	CLASSROOM SECURITY			
WW	INSTITUTIONAL	F30		
KEYED DOUBLE CYLINDER, WITH DEADBOLT				
AC	ENTRANCE	F35	1954.73	
C	STOREROOM	F14		
FA	DORMITORY	F11		
FX	DORMITORY	F33		
KEYLESS				
N	PASSAGE	F01	1794.63	
L	BATHROOM	F02	1918.90	
LF	PRIVACY	F19		
LJ	PRIVACY	F22	1857.33	
EX	EXIT	F31		
DUMMY TRIM				
DI	DUMMY TRIM INSIDE		559.77	
DO	DUMMY TRIM OUTSIDE			
DT	FULLY DUMMY		1253.89	

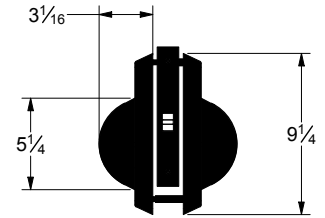
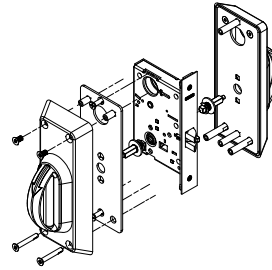

Performance Specifications:

- **Rating:** ANSI A156.13 Grade 1, UL Listed 3Hr Fire Rating
- 5- Point Ligature Resistant slide Trim
- **Backset:** 2 3/4" Standard, 2 1/2" Consult Factory
- **Latch:** #1834, stainless Steel Nose
- **Ergonomic solid cast Stainless Steel Slide,** Slides down freely in the locked or unlocked position
- **Escutcheon Plate solid cast Stainless Steel** thru bolted for strength and easy installation
- Designed to meet **BHMA 156.34 Anti Ligature Trim Standard**
- Tamper Resistant mounting screws
- Ligature Resistant ADA Thumbturn available where applicable
- **Strike:** #1135, 4 7/8" ASA curved lip Strike
- **Door Thickness:** 1 3/4"
- **Cylinder:** Marks C Keyway, 6 pin w/2 keys – Available in IC and All OEM cylinder preps
- Marks Hi-Security Cylinder available
- **Marks Stainless Steel Retractor** - Long life 3X the BHMA Grade 1 cycle Standard
- Antimicrobial Finish available – Code AM
- **Marks Lifetime Mechanical Warranty**
- Available in Most BHMA ANSI Functions

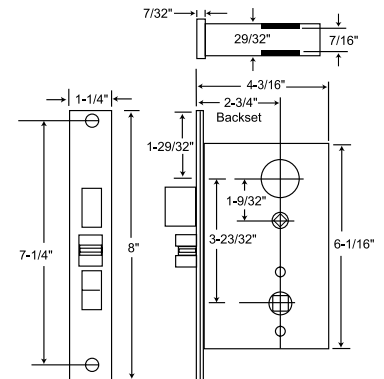

*** Standard & HI-SECURITY™ IC Core Models:** 
 Interchangeable Core models for 6 or 7 pin cores (not included).
Accepts: Marks, Marks HI-SECURITY™, Medeco®, KeyMark™, Falcon, Schlage® small format & Best®. **IC Core Tailpieces ARE Included.**

Antimicrobial Finish Available
Option Code: AM

How To Order					
5BH	J	/	32D	—	G3
1. Lockset Series	2. Marks Function	Slash	3. Finish	Dash	4. Options



Institutional Life Safety

GRADE 1 195SS LifeSaver™ CYLINDRICAL LEVERSETS

		ANSI-A156.2 • Grade 1 3 Hour Fire Rating		195SS SERIES
195SS Series Leversets Shown Below				Standard Features
				<ul style="list-style-type: none"> • ANSI-A156.2 Grade 1, UL listed 3 Hr. Fire Rating • Backset: 2-3/4" Standard, 2-3/8", 3-3/4", 5" Available • Latch #1834, stainless steel nose • Levers: Solid cast stainless steel. Levers Rotate up & down freely in locked or unlocked position • Levers recessed into solid stainless steel roses eliminating any open gap • Roses: Thru-bolted, spring loaded, #10 thru-bolts • Strike: #1135, 4-7/8" ASA curved lip strike • Door thickness: 1-3/4" +/- 1/16" • Cylinder: MARKS "C" keyway, 6 pin w/ 2 keys • Stainless steel retractor

SERIES 1SS19					
MARKS #		DESCRIPTION	ANSI #	FINISH	PRICE
COMM. CYL.	ACCEPTS IC CORE CYL.*				
N	—	PASSAGE	F75	32D	938.18
L	—	PRIVACY	F76		962.81
LK	—	PRIVACY	F76 MOD.		993.04
P	—	PATIO	F77		957.21
DC	RDC	COMMUNICATING	F80		1029.98
B	RB	ENTRY	F82A		981.84
AQ	—	EXIT	F83		968.41
S	RS	CLASSROOM	F84		981.84
F	RF	STOREROOM	F86		981.84
DW	RDW	INSTITUTION	F87		1029.98
DA	RDA	VESTIBULE	F88		1029.98
FQ	—	EXIT	F89		968.41
T	—	CORRIDOR	F90		993.04
TK	—	HOSPITAL/PRIV.	F90 MOD.		957.21
GB	RGB	STORE DOOR	F91		993.04
BS	RBS	SVC. STATION LOCK	F92		1041.18
DO	—	DUMMY TRIM OUTSIDE	—		774.73
DT	—	FULL DUMMY TRIM	—		890.04
NB	—	COMM. PASSAGE	F111		914.67
FB	RFB	COMM. STOREROOM	F112		974.01
SB	RSB	COMM. CLASSROOM	F113	974.01	
FEL	RFEL	ELECTRICALLY LOCKED		1175.52	
FEU	RFEU	ELECTRICALLY UNLOCKED		1175.52	

PACKED 6 PER CASE

Institutional Life Safety

OPTIONS	CODE	PRICE	OPTIONS	CODE	PRICE
For 2" doors	D1	52	Sargent conventional cylinder	F8	24
For 2-1/4" doors, Consult Factory	D2		Corbin conventional cylinder	F9	24
Over 2-1/4" - 4" thickness	D9	667	Corbin 6 pin IC core	F12	35
2-3/8" backset, 1" x 2-1/4" face	E6	NC	Yale 6 pin IC core	F14	24
5" backset, 9/16" throw, Gr. 1	E9	48	Sargent IC core	F20	24
3-3/4" backset, 9/16" throw, Gr. 1	E10	48	Medeco IC core large format	F21	24
Less cylinder	G3	Deduct 15			
2-3/4" "T" strike	S3	NC			

How To Order					
195SS	F	/	32D	—	G3
1. Lockset Series	2. Marks Function	3. Slash	3. Finish	4. Dash	4. Options

Standard & HI-SECURITY™ IC Core Models: Interchangeable Core models for 6 or 7 pin cores (not included). **Accepts:** Marks, Marks HI-SECURITY™, Medeco®, KeyMark™, Falcon, Schlage® small format & Best®. **IC Core Tailpieces ARE Included.**



Antimicrobial Finish Available
Option Code: AM

SERIES 5SS55 KNOB & 5SS19 LEVER

INSTITUTIONAL LifeSaver™ MORTISE LOCKSETS

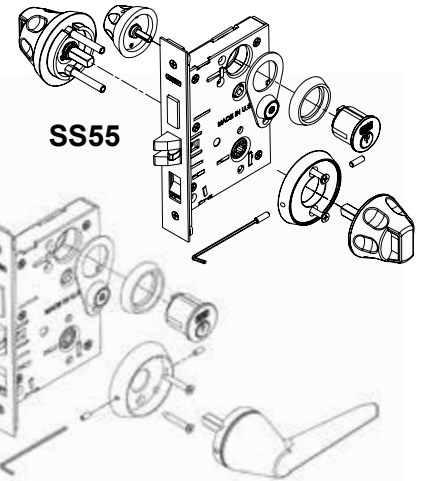

SERIES 5			FINISH 32D	
MARKS #	FUNCTION	ANSI #	5SS55 Knob	5SS19 Lever
KEYED SINGLE CYLINDER, NO DEADBOLT				
D	OFFICE VEST.		1229.26	1229.26
DW	VESTIBULE			
E	OFFICE	F04		
EW	STOREROOM	F07		
J	CLASSROOM	F05		
GL	INSTIT. PRIVACY	F26		
EL	ELECTRICALLY LOCKED		1587.52	1587.52
EU	ELECTRICALLY UNLOCKED			
KEYED SINGLE CYLINDER, WITH DEADBOLT				
A	ENTRANCE	F08, F10	1428.54	1428.54
B	ENTRANCE	F21		
F	DORMITORY	F12		
FS	DORMITORY			
FW	DORMITORY	F13		
KEYED DOUBLE CYLINDER, NO DEADBOLT				
G	APARTMENT	F09	1262.85	1262.85
GC	INTRUDER LATCHBOLT	F32		
GG	CLASSROOM SECURITY			
WW	INSTITUTIONAL	F30		
KEYED DOUBLE CYLINDER, WITH DEADBOLT				
AC	ENTRANCE	F35	1262.85	1262.85
C	STOREROOM	F14		
FA	DORMITORY	F11		
FX	DORMITORY	F33		
KEYLESS				
N	PASSAGE	F01	1184.48	1184.48
L	BATHROOM	F02	1408.39	1408.39
LF	PRIVACY	F19		
LJ	PRIVACY	F22		
EX	EXIT	F31	1441.98	1441.98
DUMMY TRIM				
DI	DUMMY TRIM INSIDE		653.82	653.82
DO	DUMMY TRIM OUTSIDE			
DT	FULLY DUMMY		1304.27	1304.27

Performance Specifications:

Life Test: 1,500,000 cycles minimum.

ANSI Test: Meets or exceeds all operational and security tests of ANSI specifications A156.13-2005 for series 5000, Grade 1.

Trim Specifications:

Exterior & Interior Trim:

- Solid stainless steel interior and exterior tapered knobs or levers recessed into thru-bolted roses.
- Safety knobs with recessed grip and finger indents (*Patent #D587556*).
- Safety lever for handicapped access on clutch operated Mortise lock.
- Ergonomically designed grooved turn knob for deadbolt functions.

Cylinder: Solid stainless steel cylinders with solid stainless steel security collars; Optional HI-SECURITY™ cylinders available

Strike: 4-7/8" curved lip stainless steel w/tamperproof screws

Door Thickness: 1-3/4" standard; Extended range available

Door Prep: ANSI A115.1 lock face cutout, with 2-1/8" through hole for knob/rose assembly

Lock Specifications: 5 Series (2-3/4" Backset) 55 Series (2-1/2" Backset)

Lock Front: Adjustable bevel steel backplate 1-1/4" x 8" x 7/64" thick, Cover plate 1/16" thick with tamper proof screws

Latch: Solid stainless steel with antifriction latch lever, 3/4" throw (reversible)

Levers: Solid cast stainless steel. **Levers Rotate up & down freely in locked or unlocked position**

Aux. Deadlatch: 1/2" throw, (reversible)

Case: Stamped steel 3/32" thick, zinc dichromate finish

Hubs: Steel, 9/32" on diamond, 5/16" on square w/security separator

Hub Lock Arm: (to lock hub) Steel 1/8" thick

Spindles: Independent spring-loaded spindles

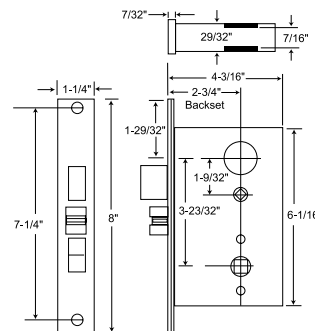

Antimicrobial Finish Available
Option Code: AM

Quick Privacy Access
A9618-1 Shown;
Option Code A25



Standard & HI-SECURITY™ IC Core Models: Interchangeable Core models for 6 or 7 pin cores (not included).
Accepts: Marks, Marks HI-SECURITY™, Medeco®, KeyMark™, Falcon, Schlage® small format & Best®. IC Core Tailpieces ARE Included.

How To Order						
5SS55 Knob	5SS19 Lever	J	/	32D	—	G3
1. Lockset Series		2. Marks Function	Slash	3. Finish	Dash	4. Options

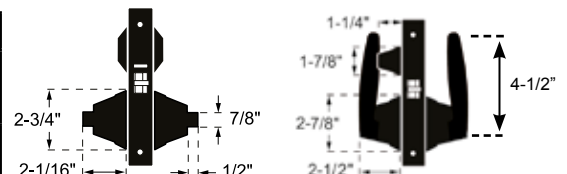

Institutional Life Safety

SERIES 180SS INSTITUTIONAL LifeSaver™ LOCKSETS

INSTITUTIONAL LIFE SAFETY CYLINDRICAL KNOBSETS & LOCKSETS

SERIES 180SS			FINISH GROUPS
MARKS #	FUNCTION	ANSI #	32D
KEYED SINGLE CYLINDER, WITH DEADBOLT			
K	CYLINDER x KNOB	E0121	1237.10
KEYLESS			
N	PASSAGE	F75	1237.10

★ **Standard & HI-SECURITY™ IC Core Models:** 
 Interchangeable Core models for 6 or 7 pin cores (not included).
Accepts: Marks, Marks HI-SECURITY™, Medeco®, KeyMark™, Falcon, Schlage® small format & Best®. **IC Core Tailpieces ARE Included.**

180SSK: Function E0121; Latch by knob inside, key outside.

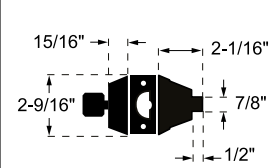
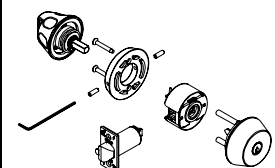
180SSN: Function F75; Latch by knob either side, always open.

Antimicrobial Finish Available
Option Code: AM

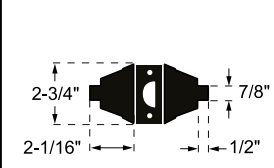
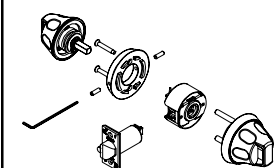

Performance Specifications

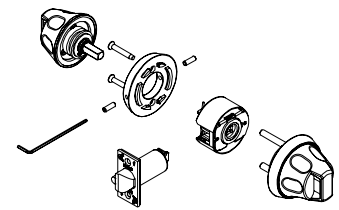
- Life Test:** 1,500,000 cycles minimum.
- ANSI Test:** Meets or exceeds all operational and security tests of ANSI specifications A156.2-2003 for series 1000, Grade 1.
- Fire Test:** UL Listed, 3 Hour fire rated. 

Exterior & Interior Trim:

- Solid stainless steel interior and exterior tapered knobs recessed into thru-bolted roses
- Specially designed finger indented safety knobs with recessed grip and ergonomically designed integral grooved turn knob for elderly and handicapped access (*Patent #D587556*)
- Needle bearings ensure smoothness of operation

1SS55K Cylindrical Deadlatch Lockset: ANSI E0121 Cylinder x Knob

- Strike:** #1136, 2-3/4" "T" strike; #1135 4-7/8" ASA strike optional
- Door Prep:** ANSI 115.2
- Latch:** ANSI 156.2, Grade 1, 3 Hour fire rated
- Door Thickness:** 1-3/4"
- Backset:** 2-3/4" Backset; 3-3/4" and 5" backsets also available
- Latch Face:** 1-1/8" x 2-1/4" with tamper proof screws
- Cylinder:** Solid brass cylinder, 6-pin, "C" keyway; Optional HI-SECURITY™ cylinders available

1SS55N Cylindrical Lockset: ANSI F75 Passage

- Strike:** #1136, 2-3/4" "T" strike
- Door Prep:** ANSI 115.2
- Latch:** ANSI 156.2, Grade 1, 3 Hour fire rated
- Backset:** 2-3/4" backset standard, 2-3/8" backset optional; 3-3/4" and 5" backsets also available
- Latch Face:** 1-1/8" x 2-1/4" with tamper proof screws
- Latch Throw:** 9/16"

Institutional Life Safety

SERIES 31SS55 INSTITUTIONAL LifeSaver™ LOCKSETS

INSTITUTIONAL LIFE SAFETY MORTISE DEADLOCK

SERIES 31SS55			 FINISH GROUPS
MARKS #	FUNCTION	ANSI #	32D
KEYED SINGLE CYLINDER, WITH DEADBOLT			
K	CYLINDER x KNOB	E06071	514.99
S	CLASSROOM	E06091	548.58

31SS55K: Function E06071; Deadbolt by outside key.
 Interior safety knob will retract but not project deadbolt.

31SS55S: Function E06091; Deadbolt by outside key.
 Turnpiece will retract but not project deadbolt.

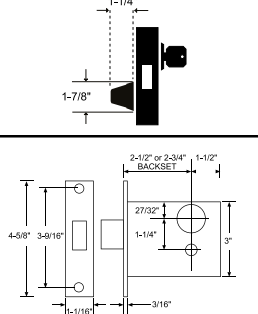
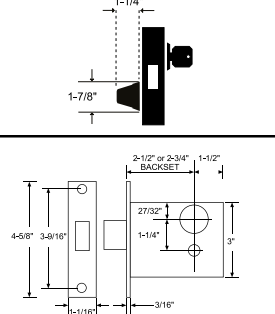
Performance Specifications:

- Life Test:** 1,500,000 cycles minimum.
- ANSI Test:** Meets or exceeds all operational and security tests of ANSI/BHMA Certified A156.5-2001 for series 31, Grade 1.

Fire Test: UL Listed, 3 Hour fire rated. 

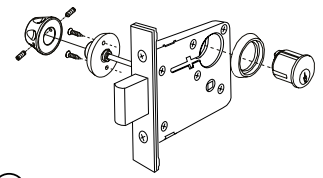

Trim Specifications:

Interior Trim: Solid stainless steel interior trim including finger indented safety knobs which recess into solid brass through-bolted roses.

Series 31 Deadlock Specifications:

- Backset:** 2-3/4"
- Bolt throw:** 1" stainless steel w/hardened roll pins
- Case:** Stamped Steel
- Front:** 1-1/16" x 4-5/8" adjustable bevel
- Cylinder:** Solid brass cylinder, 6-pin, "C" keyway, 2 keys. Optional HI-SECURITY™ cylinders available.
- Strike:** #4035 Included

Antimicrobial Finish
Option Code: AM

★ **Standard & HI-SECURITY™ IC Core Models:** 
 Interchangeable Core models for 6 or 7 pin cores (not included).
Accepts: Marks, Marks HI-SECURITY™, Medeco®, KeyMark™, Falcon, Schlage® small format & Best®. **IC Core Tailpieces ARE Included.**

SERIES 180PD & 5PD HOSPITAL LifeSaver™ LOCKSETS

CYLINDRICAL & MORTISE PUSH/PULL PADDLESETS

Hospital Push/Pull Standard Features			
<ul style="list-style-type: none"> 1-3/4" door thickness, self adjusting for thicker doors Variable mounting positions 		<ul style="list-style-type: none"> Non-Handed Easily reversible configuration for push or pull styles 	
180PD Cylindrical Standard Features		SERIES 180PD • ANSI-A156.2 • Grade 1	
<ul style="list-style-type: none"> 2-3/4" backset std., 2-3/8", 3-3/4" & 5" optional 2-3/4" "T" strike; 4-7/8" ASA strike optional Government standard #161 door prep 		 LEAD LINING & ENGRAVING AVAILABLE	
MARKS #	FUNCTION	ANSI #	FINISH: 32D Standard Consult Factory for Additional Finishes
N	PASSAGE	F75	349.76
PUSH/PULLS ARE PACKED 6 PER CASE			

5PD, 55PD Mortise Standard Features		SERIES 5PD, 55PD • ANSI-A156.13 • Grade 1	
<ul style="list-style-type: none"> 5 Series Backset: 2-3/4"; 55 Series Backset: 2-1/2" Strike: #9035, 4-7/8" ASA curved lip strike 		 LEAD LINING & ENGRAVING AVAILABLE	
MARKS #	FUNCTION	ANSI #	FINISH: 32D Standard Consult Factory for Additional Finishes
KEYED SINGLE CYLINDER, NO DEADBOLT			
D	OFFICE VEST.		847.50
DW	VESTIBULE		
E	OFFICE	F04	
EW	STOREROOM	F07	
J	CLASSROOM	F05	
JM, JR	HOSPITAL	F06	
GL	INSTITUTIONAL PRIVACY	F26	1227.02
EL	ELECTRICALLY LOCKED		
EU	ELECTRICALLY UNLOCKED		

KEYED SINGLE CYLINDER, WITH DEADBOLT			
A	ENTRANCE	F08, F10	865.41
B	ENTRANCE	F21	
F	DORMITORY	F12	
FS	DORMITORY		
FW	DORMITORY	F13	
FD	APARTMENT	F20	891.16
H	HOTEL	F15	
LH	SPECIAL PRIVACY		

KEYED DOUBLE CYLINDER, NO DEADBOLT			
G	APARTMENT	F09	902.35
GC	INTRUDER LATCHBOLT	F32	
GG	CLASSROOM SECURITY		
GR	CLASSROOM SECURITY w/ HOLDBACK		
WW	INSTITUTIONAL	F30	

KEYED DOUBLE CYLINDER, WITH DEADBOLT			
AC	ENTRANCE	F35	902.35
C	STOREROOM	F14	
FC	INTRUDER DEADBOLT	F34	
FA	DORMITORY	F11	
FX	DORMITORY	F33	

KEYLESS			
N	PASSAGE	F01	729.94
L	BATHROOM	F02	865.41
LF	PRIVACY	F19	
LJ	PRIVACY	F22	793.76
EX	EXIT	F31	

180PD Cylindrical Paddleset

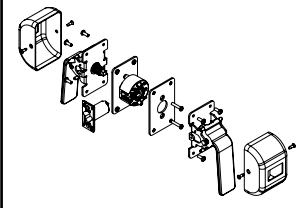
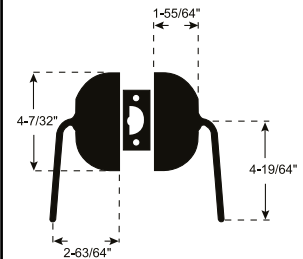

5PD Mortise Paddleset

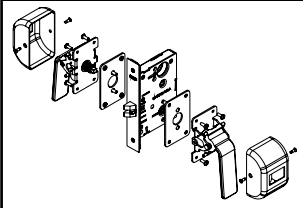
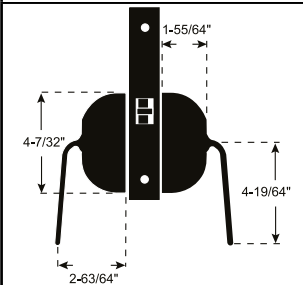

How To Order

5PD or 180PD	F	/	32D	—	G3
<i>1. Lockset Series</i>	<i>2. Marks Function</i>	<i>Slash</i>	<i>3. Finish</i>	<i>Dash</i>	<i>4. Options</i>

Hospital Push/Pull Paddlesets

MORTISE LOCK CYLINDERS

Cylinders

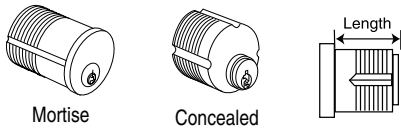

IC Core Cylinder Housings

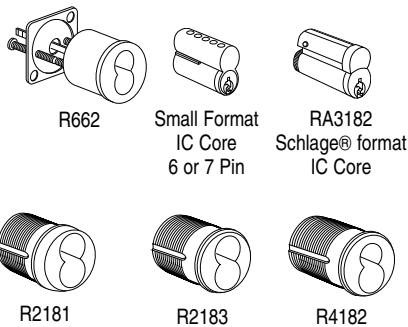

IC core pricing includes KA, KD or MK keying.

* **Standard & HI-SECURITY™ IC Core Models:**
 Interchangeable Core models for 6 or 7 pin cores (not included).
Accepts: Marks, Marks HI-SECURITY™, Medeco®, KeyMark™, Falcon, Schlage® small format & Best®. **IC Core Tailpieces ARE Included.**

PART #	DESCRIPTION	PINS	LENGTH	FINISH GROUPS		
				3, 26D	5, 10, 10B, 15, 26, 32D	3E
2122	Mortise	5	15/16"	94.41	100.08	137.84
2181	Mortise	6	2-7/8"	821.38	—	—
2182	Mortise	6	1-1/8"	103.35	115.18	143.51
2183	Mortise	6	1-1/4"	103.85	115.18	143.51
2193	Concealed	5	15/16"	137.84	—	—
2194	Concealed	6	1-1/8"	145.39	—	—
2196	Mortise	6	2-3/8"	572.14	—	—
2197	Mortise	6	1-3/4"	220.92	232.25	260.58
2198	Mortise	6	1-1/2"	177.49	183.16	220.92
662	Rim	6	—	103.85	115.18	—
* R2181	Mortise IC Core Housing	6	1"	103.85	115.18	—
* R2182	Mortise IC Core Housing	6	1-1/4"	94.41	100.08	—
* R2183	Mortise IC Core Housing	6 or 7	1-3/8"	94.41	100.08	—
* R2184	IC Core Cylinder Housing	6 or 7	1-3/4"	219.04	219.04	219.04
* R3182	Schlage® type IC Core, Uncombined	6	—	219.04	—	—
* R4182	Schlage® type IC Core Housing	6	1-1/2"	253.02	260.58	—
* R662	Rim IC Core Housing	6 or 7	1-3/8"	109.52	115.18	—
* R1182	6 Pin Core, Uncombined			83.08	—	—
* R1183	7 Pin Core, Uncombined			83.08	—	—
* RA1182	6 Pin Core, Combined			122.74	126.51	—
* RA1183	7 Pin Core, Combined			122.74	126.51	—
* RA3182	Schlage® type IC Core, Combined	6		260.58	—	—
* RC1182	6 Pin Core, Construction Core			86.86	—	—
* RC1187	Plastic Core Turn Knob			16.99	—	—
* RC3182	Schlage® type Construction Core			219.04	—	—
* RM1182	Marketry Core			90.64	—	—

Cylinder Cams



PART #	DESCRIPTION	USE WITH MORTISE LOCK	CODE	PRICE
2101	STRAIGHT CAM	MARKS	1	8.35
2101-A		ARROW/SARGENT	A1	8.35
2101-C		CORBIN RUSSWIN	C1	8.35
2101-S		SCHLAGE	S1	8.35
2102	CLOVERLEAF CAM	MARKS	2	8.35
2102-A		ARROW/SARGENT	A2	8.35
2102-C		CORBIN RUSSWIN	C2	8.35
2102-S		SCHLAGE	S2	8.35

PART #	DESCRIPTION	USE WITH MORTISE LOCK	CODE	PRICE
2104	ADAMS-RITE CAM	MARKS	4	8.35
2105	"J" FUNCTION CAM	MARKS	5	8.35
2105-A		ARROW/SARGENT	A5	8.35
2105-C		CORBIN RUSSWIN	C5	8.35
2105-S		SCHLAGE	S5	8.35
2107-CL	"J-CL" FUNCTION CAM	MARKS	7	8.35
2106	"G" CAM Exterior only	MARKS	6	8.35
2106-A		ARROW/SARGENT	A6	8.35
2106-C		CORBIN RUSSWIN	C6	8.35
2106-S		SCHLAGE	S6	8.35

Mortise Cylinders, Parts, Cams

How To Order Example for Mortise Lock Cylinders

2182	/	32D	—	1C
1. <i>Cylinder</i>	<i>Slash</i>	2. <i>Finish</i>	<i>Dash</i>	3. <i>Options</i>

See List Of Cylinders Available

FINISH (Pg. 8)

- 3
- 5
- 10
- 15
- 26
- 26D
- 32D

Special Specify

- Keying
- Door Thickness

Cam and keying information must be included in the option section.

KEYS & KEYING

Keys

Can Stamp A Maximum Of 6 Characters On Key.

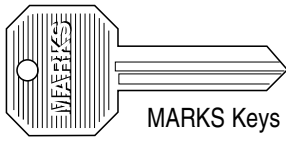

MARKS Keys

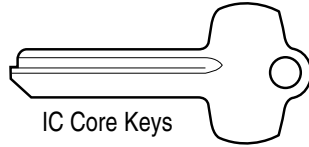

IC Core Keys

STANDARD KEYWAYS	PIN LENGTH ACCEPTS	SHOULDER INCREMENTS	PIN TO PIN TO 1st PIN	PLUG DISTANCE	DIAMETER
MARKS "A"	Arrow Kwikset Segal 9	.015"	.264"	.156"	.504"
MARKS "C"	Schlage "C"	.015"	.231"	.156"	.504"

PART #	DESCRIPTION	PRICE	
		BLANK	CUT
2164A	MARKS "A" 5 PIN BRASS	7	9
2164C	MARKS "C" 5 PIN BRASS, NICKEL PLATED	7	9
2184A	MARKS "A" 6 PIN NICKEL SILVER	8	10
2184C	MARKS "C" 6 PIN NICKEL SILVER	8	10
R1164	IC CORE 6 OR 7 PIN (SMALL FORMAT)	8	10
R3164	SCHLAGE® IC CORE CONTROL KEY	8	10

BEST® A thru M keyway. Please specify.
IC Core pricing includes KA, KD or MK Keying.

PART #	DESCRIPTION	PRICE	
		REGULAR	IC CORE
KA	KEYED ALIKE	NC	NC
KD	KEYED DIFFERENT	NC	NC
MK	MASTER KEYED	22	NC
CMK	CONSTRUCTION MASTER KEYED (Includes GMK or MK)	32	—
GMK	GRAND MASTER KEYED	22	14
GGMK	GREAT GRAND MASTER KEYED	22	14
GGGMK	GREAT GREAT GRAND MASTER KEYED	22	—
HK	HOTEL KEYED (Guest, Maid, Emergency)	29	—
KEYING TO A SPECIFIC CODE NUMBER		16	16
STAMPING		PRICE	
LETTERS/NUMBERS ON KEY		8 PER KEY	
US PROPERTY - "DO NOT DUPLICATE"		8 PER KEY	
VISUAL KEY CONTROL (VKC)		7	
CONCEAL KEY CONTROL		16	
EXTRA CUT KEYS WITH LOCKSET		SEE KEYS ABOVE	
KEY BITTING CODE LIST		N/C	

IC CORE PRICING INCLUDES KA, KD OR MK KEYING

Construction Master Keying:

The construction master key (CMK) is to be used temporarily while the building is under construction. When construction is completed, the end user defeats the CMK's operation by turning the change key in each cylinder, rather than replace or re-keying the cylinder.

Marks USA uses a program which is called the "lost ball" program. When construction key system is set up, three small ball bearings (construction balls) are placed between the bottom pin and master pin, normally in the last chamber as a "temporary master pin". The construction key is usually the same cut as the top master key with the exception of the sixth cut which is two increments higher. The construction master key will work in any cylinder until cylinder is "defeated" by making one full rotation in the cylinder with the change key. The cylinder plug requires a small diameter "pocket" drilled on one side of one pin chamber so when rotating the cylinder with the change key the pocket will capture the construction balls. The construction pocket in the plug is smaller than a pin chamber. This prevents any top pins or master pins from entering as the plug rotates. Once the cylinder is defeated, there is no way for the cylinder to be construction keyed again without disassembling it.

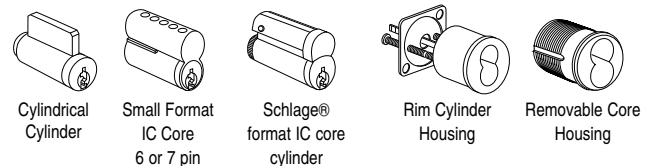
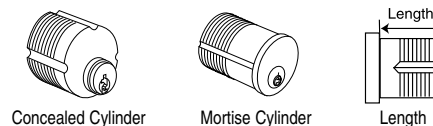
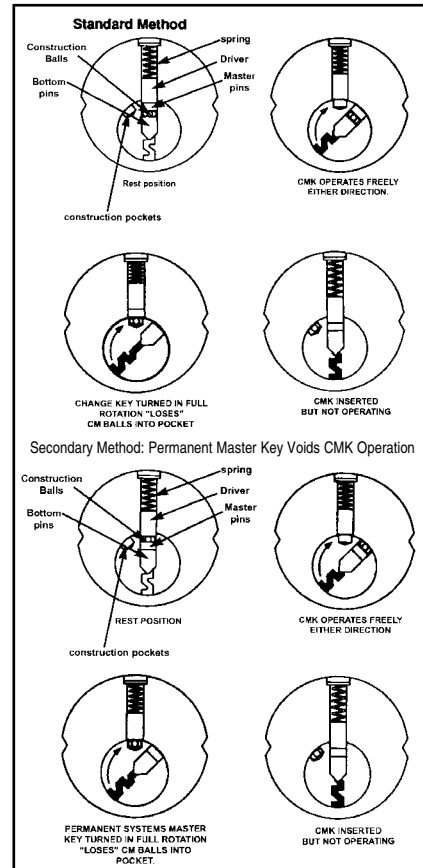



★ **Standard & HI-SECURITY™ IC Core Models:** Interchangeable Core models for 6 or 7 pin cores (not included).
Accepts: Marks, Marks HI-SECURITY™, Medeco®, KeyMark™, Falcon, Schlage® small format & Best®. **IC Core Tailpieces ARE Included.**

HI-SECURITY™ CYLINDERS: NON-UL





HI-SECURITY™ MORTISE CYLINDERS						
	NON-UL "0" Bitted x 2 Keys; "0" Bitted "NO KEYS" - Deduct \$7		FINISH GROUPS			
	PART #	DESCRIPTION	3, 26D	4, 5, 10, 10B, 15, 26, 32D	3E	
	BXXX-D001A0N2	1-1/8" Mortise Cylinder	139.73	151.06	177.49	
	CXXX-D001A0N2	1-1/4" Mortise Cylinder	151.06	164.28	188.82	
	DXXX-D001A0N2	1-3/8" Mortise Cylinder	175.61	185.05	211.48	
	NON-UL KD x 2 Keys					
	BXXX-D001A1N2	1-1/8" Mortise Cylinder	152.95	168.05	196.38	
	CXXX-D001A1N2	1-1/4" Mortise Cylinder	168.05	175.61	203.93	
	DXXX-D001A1N2	1-3/8" Mortise Cylinder	190.71	200.15	228.48	
	HI-SECURITY™ CYLINDERS ARE PACKED 24 PER CASE					

HI-SECURITY™ MORTISE/RIM COMBO CYLINDERS						
	NON-UL "0" Bitted x 2 Keys; "0" Bitted "NO KEYS" - Deduct \$7		FINISH GROUPS			
	PART #	DESCRIPTION	3, 26D	4, 5, 10, 10B, 15, 26, 32D	3E	
	EXXX-D001A0N2	1" Combo Cylinder	126.51	135.95	166.16	
	FXXX-D001A0N2	1-1/8" Combo Cylinder	151.06	164.28	188.82	
	NON-UL KD x 2 Keys					
	EXXX-D001A1N2	1" Combo Cylinder	141.62	151.06	177.49	
	FXXX-D001A1N2	1-1/8" Combo Cylinder	168.05	175.61	203.93	
	HI-SECURITY™ CYLINDERS ARE PACKED 24 PER CASE					

HI-SECURITY™ KIK CYLINDERS				
	NON-UL "0" Bitted x 2 Keys; "0" Bitted "NO KEYS" - Deduct \$6		FINISH GROUPS	
	PART #	DESCRIPTION	26D	
	G26D-D001X0N2	Key-In-Knob Cylinder	115.18	
	NON-UL KD x 2 Keys			
	G26D-D001X1N2	Key-In-Knob Cylinder	126.51	
	HI-SECURITY™ CYLINDERS ARE PACKED 24 PER CASE			

HI-SECURITY™ MARKS IC CORE CYLINDERS				
	NON-UL "0" Bitted x 2 Keys x 1 Control Key; "0" Bitted "NO KEYS" - Deduct \$6		FINISH GROUPS	
	PART #	DESCRIPTION	26D	
	H26D-D001X0N2	6 Pin IC Core Cylinder	126.51	
	J26D-D001X0N2	7 Pin IC Core Cylinder	132.18	
	NON-UL KD x 2 Keys x 1 Control Key			
	H26D-D001X1N2	6 Pin IC Core Cylinder	147.28	
	J26D-D001X1N2	7 Pin IC Core Cylinder	152.95	
HI-SECURITY™ CYLINDERS ARE PACKED 24 PER CASE				

HI-SECURITY™ Schlage® LARGE FORMAT IC CORE CYLINDERS				
	NON-UL "0" Bitted x 2 Keys x 1 Control Key; "0" Bitted "NO KEYS" - Deduct \$6		FINISH GROUPS	
	PART #	DESCRIPTION	26D	
	K26D-D001X0N2	6 Pin Schlage® IC Core Cylinder	160.50	
	NON-UL KD x 2 Keys x 1 Control Key			
	K26D-D001X1N2	6 Pin Schlage® IC Core Cylinder	179.38	
HI-SECURITY™ CYLINDERS ARE PACKED 24 PER CASE				

HI-SECURITY™ Medeco® LARGE FORMAT IC CORE CYLINDERS				
	NON-UL "0" Bitted x 2 Keys x 1 Control Key; "0" Bitted "NO KEYS" - Deduct \$6		FINISH GROUPS	
	PART #	DESCRIPTION	26D	
	P26D-D001X0N2	6 Pin Medeco® IC Core Cylinder	196.38	
	NON-UL KD x 2 Keys x 1 Control Key			
	P26D-D001X1N2	6 Pin Medeco® IC Core Cylinder	217.15	
HI-SECURITY™ CYLINDERS ARE PACKED 24 PER CASE				

HI-SECURITY™
Cylinders

HI-SECURITY™ CYLINDERS: UL 437



HI-SECURITY™ MORTISE CYLINDERS					
	UL 437 "0" Bitted x 2 Keys; "0" Bitted "NO KEYS" - Deduct \$7		FINISH GROUPS		
	PART #	DESCRIPTION	3, 26D	4, 5, 10, 10B, 15, 26, 32D	3E
	BXXX-D001A0U2	1-1/8" Mortise Cylinder	175.61	185.05	211.48
	CXXX-D001A0U2	1-1/4" Mortise Cylinder	179.38	190.71	217.15
	DXXX-D001A0U2	1-3/8" Mortise Cylinder	209.59	220.92	249.25
	UL 437 KD x 2 Keys				
	BXXX-D001A1U2	1-1/8" Mortise Cylinder	190.71	200.15	228.48
	CXXX-D001A1U2	1-1/4" Mortise Cylinder	196.38	207.71	232.25
	DXXX-D001A1U2	1-3/8" Mortise Cylinder	226.59	234.14	260.58
HI-SECURITY™ CYLINDERS ARE PACKED 24 PER CASE					

HI-SECURITY™ MORTISE/RIM COMBO CYLINDERS					
	UL 437 "0" Bitted x 2 Keys; "0" Bitted "NO KEYS" - Deduct \$7		FINISH GROUPS		
	PART #	DESCRIPTION	3, 26D	4, 5, 10, 10B, 15, 26, 32D	3E
	EXXX-D001A0U2	1" Combo Cylinder	164.28	171.83	198.26
	FXXX-D001A0U2	1-1/8" Combo Cylinder	185.05	196.38	220.92
	UL 437 KD x 2 Keys				
	EXXX-D001A1U2	1" Combo Cylinder	175.61	185.05	211.48
	FXXX-D001A1U2	1-1/8" Combo Cylinder	200.15	209.59	211.48
HI-SECURITY™ CYLINDERS ARE PACKED 24 PER CASE					

HI-SECURITY™ KIK CYLINDERS			
	UL 437 "0" Bitted x 2 Keys; "0" Bitted "NO KEYS" - Deduct \$7		FINISH GROUPS
	PART #	DESCRIPTION	26D
	G26D-D001X0U2	Key-In-Knob Cylinder	145.39
	UL 437 KD x 2 Keys		
	G26D-D001X1U2	Key-In-Knob Cylinder	164.28
HI-SECURITY™ CYLINDERS ARE PACKED 24 PER CASE			

HI-SECURITY™ Schlage® LARGE FORMAT IC CORE CYLINDERS			
	UL 437 "0" Bitted x 2 Keys x 1 Control Key; "0" Bitted "NO KEYS" - Deduct \$6		FINISH GROUPS
	PART #	DESCRIPTION	26D
	K26D-D001X0U2	6 Pin Schlage® IC Core Cylinder	288.85
	NON-UL KD x 2 Keys x 1 Control Key		
	K26D-D001X1U2	6 Pin Schlage® IC Core Cylinder	209.59
HI-SECURITY™ CYLINDERS ARE PACKED 24 PER CASE			

HI-SECURITY™ Medeco® LARGE FORMAT IC CORE CYLINDERS			
	UL 437 "0" Bitted x 2 Keys x 1 Control Key; "0" Bitted "NO KEYS" - Deduct \$6		FINISH GROUPS
	PART #	DESCRIPTION	26D
	P26D-D001X0U2	6 Pin Medeco® IC Core Cylinder	224.70
	NON-UL KD x 2 Keys x 1 Control Key		
	P26D-D001X1U2	6 Pin Medeco® IC Core Cylinder	249.25
HI-SECURITY™ CYLINDERS ARE PACKED 24 PER CASE			

HI-SECURITY™
Cylinders

HI-SECURITY™ CYLINDERS





Security-Mate™ & SPECIAL APPLICATION CYLINDERS

Security-Mate™ MORTISE CYLINDERS				
	"0" Bitted "NO KEYS"		FINISH GROUPS	
	PART #	DESCRIPTION	3, 26D	4, 5, 10, 10B, 15, 26, 32D
	BXXX-DXXXXA0N0	1-1/8" Mortise Cylinder	109.52	151.06
	CXXX-DXXXXA0N0	1-1/4" Mortise Cylinder	118.96	164.28
	DXXX-DXXXXA0N0	1-3/8" Mortise Cylinder	139.73	185.05
	LXXX-DXXXXA0N0	1-1/2" Mortise Cylinder	164.28	205.82
	MXXX-DXXXXA0N0	1-3/4" Mortise Cylinder	185.05	234.14
Security-Mate™ CYLINDERS ARE PACKED 24 PER CASE				

Security-Mate™ MORTISE/RIM COMBO CYLINDERS				
	"0" Bitted "NO KEYS"		FINISH GROUPS	
	PART #	DESCRIPTION	3, 26D	4, 5, 10, 10B, 15, 26, 32D
	EXXX-DXXXXA0N0	1" Combo Cylinder	90.64	103.85
	FXXX-DXXXXA0N0	1-1/8" Combo Cylinder	118.96	126.51
	Security-Mate™ CYLINDERS ARE PACKED 24 PER CASE			

Security-Mate™ KIK CYLINDERS			
	"0" Bitted "NO KEYS"		FINISH GROUPS
	PART #	DESCRIPTION	26D
	G26D-DXXXXX0N0	Key-In-Knob Cylinder	84.97
Security-Mate™ CYLINDERS ARE PACKED 24 PER CASE			

Security-Mate™ MARKS IC CORE CYLINDERS			
	"0" Bitted "NO KEYS"		FINISH GROUPS
	PART #	DESCRIPTION	26D
	H26D-DXXXXX0N0	6 Pin IC Core Cylinder	94.41
	J26D-DXXXXX0N0	7 Pin IC Core Cylinder	103.85
Security-Mate™ CYLINDERS ARE PACKED 24 PER CASE			

Security-Mate® Schlage™ LARGE FORMAT IC CORE CYLINDERS			
	"0" Bitted "NO KEYS"		FINISH GROUPS
	PART #	DESCRIPTION	26D
	K26D-DXXXXX0N0	6 Pin Schlage® IC Core Cylinder	130.29
Security-Mate™ CYLINDERS ARE PACKED 24 PER CASE			

Security-Mate® Medeco™ LARGE FORMAT IC CORE CYLINDERS			
	"0" Bitted "NO KEYS"		FINISH GROUPS
	PART #	DESCRIPTION	26D
	P26D-DXXXXX0N0	6 Pin Medeco® IC Core Cylinder	168.05
Security-Mate™ CYLINDERS ARE PACKED 24 PER CASE			

HI-SECURITY™ SPECIAL APPLICATION CYLINDERS					
	KA Pair w/ 2 Keys, NON-UL, Straight Cam			FINISH GROUPS	
	PART #	DESCRIPTION	3, 26D	5, 15	
	2122XXXHSM	15/16" Mortise Cylinders	196.38	217.15	
HI-SECURITY™ SPECIAL APPLICATION CYLINDERS ARE PACKED 24 PER CASE					

HI-SECURITY™ CYLINDERS

HOW TO ORDER HI-SECURITY™ CYLINDERS AND KEYS

How To Order Example for HI-SECURITY™ Cylinders								
D	3	—	D	001	A	3	U	2
1. Cylinder Type	2. Finish	Dash	3. Keyway	4. Security Code	5. Cam Tail	6. Keying	7. NON-UL / UL437	8. # of Keys

CYLINDER TYPE	FINISH	KEYWAY	SECURITY CODE	CAM TAIL <i>MORTISE</i>	KEYING	UL or NON-UL	KEYING
<input type="checkbox"/> B = 1-1/8" Mortise <input type="checkbox"/> C = 1-1/4" Mortise <input type="checkbox"/> D = 1-3/8" Mortise <input type="checkbox"/> L = 1-1/2" Mortise <input type="checkbox"/> M = 1-3/4" Mortise <input type="checkbox"/> E = 1" Combo <input type="checkbox"/> F = 1-1/8" Combo <input type="checkbox"/> G = KIK Cylinder <input type="checkbox"/> H = IC Core Marks 6 Pin <input type="checkbox"/> J = IC Core Marks 7 Pin <input type="checkbox"/> K = IC Core Schlage® Large Format <input type="checkbox"/> P = IC Core Medeco® Large Format	<input type="checkbox"/> 3 <input type="checkbox"/> 4 <input type="checkbox"/> 5 <input type="checkbox"/> 10 <input type="checkbox"/> 10B <input type="checkbox"/> 15 <input type="checkbox"/> 26 <input type="checkbox"/> 26D <input type="checkbox"/> 32 <input type="checkbox"/> 32D	<input type="checkbox"/> D = HS	<input type="checkbox"/> 001 = MARKS	<input type="checkbox"/> A = 2101 <input type="checkbox"/> B = 2102 <input type="checkbox"/> D = 2104 <input type="checkbox"/> E = 2105 <input type="checkbox"/> F = 2106 <i>KIK</i> <input type="checkbox"/> A = Standard Tail <input type="checkbox"/> B = Classroom Tail <input type="checkbox"/> C = i-Que Electronic <i>IC CORE</i> <input type="checkbox"/> A = 6 Pin IC <input type="checkbox"/> B = 7 Pin IC	<input type="checkbox"/> 0 = "0" Bitted <input type="checkbox"/> 1 = KD <input type="checkbox"/> 2 = KA <input type="checkbox"/> 3 = CMK <input type="checkbox"/> 4 = GMK <input type="checkbox"/> 5 = MK <input type="checkbox"/> 6 = GG MK	<input type="checkbox"/> U = UL 437 <input type="checkbox"/> N = NON UL	<input type="checkbox"/> 0 = "0" Bitted <input type="checkbox"/> 1 = 1 Key <input type="checkbox"/> 2 = 2 Keys <input type="checkbox"/> 3 = 3 Keys Up to 9, Then as separate line item

How To Order Example for HI-SECURITY™ Keys				
HS	6	D	001	C
1. Key Type	2. Pins	3. Keyway	4. Security Code	5. Special Key Type

KEY TYPE	PINS	KEYWAY	SECURITY CODE	SPECIAL KEY TYPE
<input type="checkbox"/> HS = HI-SECURITY™ <input type="checkbox"/> RS = IC Core	<input type="checkbox"/> 5 Pin <input type="checkbox"/> 6 Pin <input type="checkbox"/> 7 Pin	<input type="checkbox"/> D = HS	<input type="checkbox"/> 001 = Marks	<input type="checkbox"/> C = Control Key

HI-SECURITY™
Cylinders







HI-SECURITY™ CYLINDERS









KEYS, CAMS & TAILPIECES

KEYS			
	PART #	DESCRIPTION	PRICE
	HS5D001	5 Pin Key Blank	17
	HS6D001	6 Pin Key Blank	17
	RS6D001	6 Pin IC Key Blank	17
	RS7D001	7 Pin IC Key Blank	17
	Schlage® IC CORE CONTROL KEY		
HSR3184	6 or 7 Pin IC Key Blank	17	
CUT KEYS			
Conventional Cylinder			12
IC Core Cylinder			12

KEYING CHARGES		
PART #	DESCRIPTION	PRICE
KA, KD	Keyed Alike, Keyed Different	NC
MK	Master Keyed	22
GMK	Grand Master Keyed	22
GGMK	Great Grand Master Keyed	22
VKC	Visual Key Control	15

MORTISE CYLINDER CAMS			
PART #	DESCRIPTION	PRICE	
 2101HS	Straight Cam	11.35	
 2102HS	Clover Cam	11.35	
 2104HS	Adams Rite Cam	11.35	
 2105HS	J - Cam	11.35	
 2106HS	G - Cam	11.35	
 2107-CLHS	Straight Cam	11.35	

Schlage® LARGE FORMAT IC CORE HOUSING CAMS			
PART #	DESCRIPTION	PRICE	
 2101 HSPM	Straight Cam	11.35	
 2102 HSPM	Clover Cam	11.35	
 2104 HSPM	Adams Rite Cam	11.35	
 2105 HSPM	J - Cam	11.35	
 2106 HSPM	G - Cam	11.35	
 2107-CL HSPM	Straight Cam	11.35	

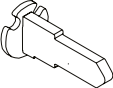
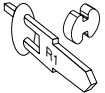
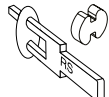
CYLINDRICAL TAIL PIECES			
PART #	FUNCTIONS	PRICE	
 F1903-C	AB, DW, F	9.59	
 F1903S-C	S, DA, DB, DC, SB, T	9.59	
IC CORE TAILPIECES			
 HR1984-HS	AB, B, DA (ext.), DW, F, FEU, FEL	9.59	
 HR1984S-HS	S, DA (int.), DB, DC, SB, T	9.59	

HI-SECURITY™
Cylinders

HI-SECURITY™ CYLINDERS



PARTS LIST

PARTS LIST			
PART #	DESCRIPTION	PRICE	PACKED
P2031	Finger Pins #1 (Silver)	49.09	25 per pack
P2032	Finger Pins #2 (Copper)	49.09	25 per pack
P2033	Finger Pins #3 (Black)	49.09	25 per pack
P2034	Finger Pins #4 (Gold)	49.09	25 per pack
P2035	Sidebar - Schlage® IC	49.09	25 per pack
P2036	Sidebar - Combo, KIK, Mortise	49.09	25 per pack
P2051	Sidebar - Best® IC	49.09	25 per pack
P2037	Sidebar Springs	49.09	50 per pack
P2044	Mortise Cam Screws	28.32	12 per pack
P2045	IC Mortise Cam Screws - SCHLAGE® ONLY	28.32	12 per pack
P2038	Hardened Steel Pins	28.32	12 per pack
P2041	Schlage® IC Cap Pin	49.09	12 per pack
P2042	Schlage® IC Cap Pin Spring	49.09	12 per pack
P2046	Schlage® IC Screw Cap	49.09	6 per pack
P2048	KIK Screw Cap	49.09	6 per pack
P2043	Best® IC Clip	49.09	12 per pack
P2039	Top Hex Screws (HI-SECURITY™ Mortise)	28.32	12 per pack
P2029	Top Hex Screws (HI-SECURITY™ Best® IC)	28.32	12 per pack
P2047	HI-SECURITY™ Registration Card	75.53	10 cards
R2984	7 Pin IC Tailpiece (AB, DW, F)	11.33	—
R2984S	7 Pin IC Tailpiece (S, DA, DB, DC, SB, T, TS)	11.33	—
R1981	Spacer	11.33	—
2049	Plug Holder	75.53	—
BXXX-D133B1N1C	Cut Away Mortise Cylinder	209.59	—
BXXX-D133B1N1P	Plastic Mortise Cylinder	209.59	—
HSICT	Shear Tool	430.52	—
HSC387	HPC Card C387	94.41	—

HI-SECURITY™
Cylinders

SERIES M9900 EXIT DEVICE

RIM MOUNT



- EXTRUSION HEAVY GAGE 32D FINISH
- LIFETIME MECHANICAL WARRANTY
- PANIC PROTECTOR™ END CAP
- EASY INSTALLATION, ECONOMICAL



MARKS #	FUNCTION	PRICE	
		32D	10B
M9900	Rim Panic	815.72	948.78
M9900F	Fire Rated Rim Panic	919.57	1053.64
M9900 - 48	Rim Panic - 48"	898.80	1032.86
M9900F - 48	Fire Rated Rim Panic - 48"	1006.43	1140.49

OPTIONS	
M9900	33" Length for 38" Door
M9900-48"	42" Length for 48" Door

SPECIFICATIONS
• Doors: 1 3/4" thick standard
• End Cover: Stainless steel beveled "Panic Protector" design
• Strike: Roller strike
• Rail Assembly: Heavy Gauge Stainless Steel
• Dead latch Bolt: Stainless Steel 3/4" throw.
• Dead latch Bolt: Stainless Steel 5/8".
• Dogging feature: Allen Key (M9900)
• UL listed: For "Panic Hardware" and Fire Rated Model 3 hour fire doors up to 38" x 86".
• ANSI: ANSI 156.3 (2001), requirements for Grade 1
• 3 Hour Fire Rating
• Finished: Stainless steel satin finish

SERIES M9900 VR EXIT DEVICE

SURFACE VERTICAL ROD









APPLICATION
• For use on single door or pair of doors
• 1 3/4" (44 mm) door thickness standard. Specify thickness other than 1 3/4"
• RHR or LHR hollow metal, wood and mineral core doors
• Minimum Stile Width: 3 1/2" (89 mm)

MARKS #	FUNCTION	PRICE	
		32D	10B
M9900 VR	Rim Panic Vertical Rod	1083.85	1206.58
M9900F VR	Fire Rated Rim Panic Vertical Rod	1191.48	1325.54
M9900 - 48 VR	Rim Panic Vertical Rod - 48"	1136.22	1270.78
M9900F - 48 VR	Fire Rated Rim Panic Vertical Rod - 48"	1244.35	1370.86
M9900 VR ER	Vertical Rod Electric Latch Retraction	2639.76	2809.71

SPECIFICATIONS
• Device Head Cover: Zinc alloy or stainless steel
• Chassis: Steel, plated
• Mechanism Housing: Extruded aluminum
• Push Bar Base: Extruded aluminum
• Touch Plate: Stainless Steel
• End Cap: Stainless Steel
• Top Latch: Stainless Steel 37/64" (14.8mm)
• Top Strike: Included
• Bottom Latch: Stainless Steel 37/64" (14.8mm)
• Bottom Strike: Included
• Latch Case Covers: Steel, stainless steel or brass
• Vertical Rods: Aluminum tube
• Hand: Non-handed
• Mounting: Machine screws standard. Sex bolts optional. Order "SNB" for wood or unreinforced metal doors
• Dogging: Allen-type key furnished
• Finish: 32D
• Outside Trim: Order separately
• Standard Height: 7' doors
• UL listed: ANSI/BHMA Grade 1 Panic Exit Hardware
• 3-Hour Fire Rated

Exit Devices





SERIES M9900 EXTERIOR TRIM

M411	Lever/Rose	Rim Panic Vandal Pull
	 M195F	MVP/32D 
MES600A	Cylindrical Dogging Kit - 32D	Rim Panic Vandal Pull w/ cylinder hole
	 M9901 M9902	MVPCC/32D (cylinder not included) 

ENTRY LEVER TRIM
<ul style="list-style-type: none"> • Standard Marks "C" Keyway KNK cylinder for panic device. • Cylinder locks or unlocks lever, rigid when locked; when unlocked retracts latch bolt. • Marks 26D Finish / Standard 1-3/4" Door Thickness • IC Prep Code G1, Less Cylinder G3
ESCUTCHEON LEVER DESIGN
<ul style="list-style-type: none"> • Thru bolt design • Non Handed design. Easily field reversible. • Marks 32D Finish / Standard 1-3/4" Door Thickness • Standard Marks "C" Keyway 1-1/4" Mortise cylinder with special cam • IC Prep Code G1 • Less Cylinder G3

MARKS #	DESCRIPTION	PRICE	
		26D	10B
M411	Finger Pill - no cylinder	43.43	49.09
MESC600A	Lever / Escutcheon Trim Entry	249.25	330.44
MESC600F	Lever / Escutcheon Trim Storeroom	249.25	330.44
MESC600N	Lever / Escutcheon Trim Passage	215.26	300.23
MESC600DT	Lever / Escutcheon Trim Dummy Trim	215.26	300.23
MESC350A	Lever / Escutcheon Trim Entry	249.25	—
MESC350F	Lever / Escutcheon Trim Storeroom	249.25	—
M9901	36 inch Panic Device Dogging Kit	154.84	185.05
MVR8	Vertical Rod 8 ft - Code 8	77.42	—
MVR10	Vertical Rod 10 ft - Code 10	124.64	—
MVRB	Vertical Rod - Bottom Rod	52.87	—
MVP/32D	Rim Panic Vandal Pull	371.98	—
MVPCC/32D	Rim Panic Vandal Pull w/ cylinder hole	413.52	—

MORTISE CYLINDER CAMS

M9907		MESC600A - MESC350A
M9908		MESC600F - MESC350F
M9909		MESC600F IC CORE HOUSING
M9910		MESC600A IC CORE HOUSING

SERIES M8800 EXIT DEVICE

THIN LINE™ RIM MOUNT



MARKS #	FUNCTION	PRICE
		32D
M8800	Rim Panic	879.94

Specifications	
Specification:	Conforms to ANSI BHMA A156.3 Grade 1 Exit Device Requirement Standard ANSI/UL305 Standard for Safety for Panic Hardware 2013 California Building Code Sec. 11B-309.4
For Doors:	(Please specify when ordering non standard size doors) Thickness: Standard 1 3/4", may fit with door thickness up to 2" Width: Standard 36", may fit door width 30"
Mounting:	Furnished Standard with Wood and Machine Screws
Head Cover:	Zinc Alloy
Chassis:	Aluminum
Rail Assembly:	Heavy Gauge extruded aluminum with stainless steel on top of touch bar
End Cap:	Zinc Alloy
Hand:	Non-handed
Latch Bolt:	Stainless Steel, 3/4" (18mm) throw
Strike:	Roller Strike (Stainless Steel)
Dogging:	Allen Key (equipped on panic rate devices only)
Finish:	32D: Satin Stainless Steel Finish 10B: Oil Rubbed Bronze Finish
Dimension:	Touch bar height from finished floor: 41" (1041mm) from center of touch bar Touch Bar Projection: Neutral: 3 5/16" (84mm) Depressed: 2 19/32" (66mm) Head Cover: LxWxH: 206mm x 76mm x 71mm Device Length: 34 5/8" (88cm) for 36" door width 46 5/8" (118.5 cm) for 48" door width

SERIES M195 EXIT DEVICE TRIM

Specifications

Levers: Solid cast Zamac, with 1/2" return (except 495)
Roses: Thru-bolted, 3-7/16" spring loaded Roses
Door Thickness: 1-5/8" – 1-7/8"
Clutch: Standard
Chassis: Steel
Cylinder: MARKS "C" keyway, 6 pin w/ 2 keys
 IC Core model - Core not included
Lifetime Mechanical Warranty

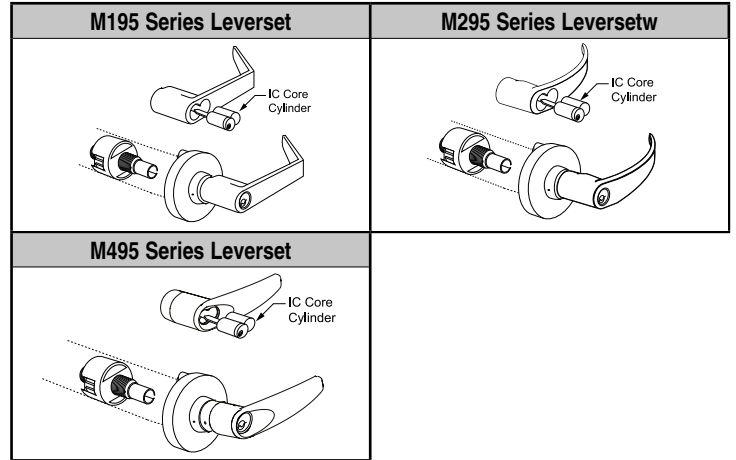

MARKS #	Trim	26D	19
M195S/295/495	Entry	309.67	390.86
M195RS/295/495	Entry with IC Core	309.67	390.86
M195F/295/495	Storeroom	309.67	390.86
M195RF/295/495	Storeroom with IC Core	309.67	390.86
M195N/295/495	Passage	287.01	349.32
M195DT/295/495	Dummy	287.01	349.32

OPTIONS	CODE	PRICE - 195	295
Yale Conventional	F7	24	—
Sargent conventional cylinder	F8	24	24
Corbin conventional cylinder	F9	24	24
Corbin 6 pin IC core	F12	35	35
Corbin 7 pin IC core	F13	35	—
Yale 6 pin IC core	F14	24	24
Yale 7 pin IC core	F15	24	—
Schlage 6 pin IC core	F19	24	24
Sargent IC core	F20	24	24
Medeco IC core large format	F21	24	24
Less Cylinder	G3	Deduct 15	—

★ **Standard & HI-SECURITY™ IC Core Models:** Interchangeable Core models for 6 or 7 pin cores (not included). **Accepts:** Marks, Marks HI-SECURITY™, Medeco®, KeyMark™, Falcon, Schlage® small format & Best®. **IC Core Tailpieces ARE Included.**

SERIES M99 NIGHT LATCH TRIM

Specifications

- Fixed pull for Marks USA rim panic devices.
- US32D stainless steel material
- US 32D finish
- Supplied with cylinder collar and mounting cylinder cup. *Available in Marks USA "C" conventional rim cylinder and Marks USA "Best size" IC rim cylinder (less core)
- Available in Dummy trim, less cylinder hole

MARKS #	Night Latch Trim	32D
M99F/32D	With Marks C Rim Cylinder	368.21
M99F/32D-G1	With Marks IC Core Rim Cylinder	368.21
M99F/32D-G3	With Cylinder hole – Less Cylinder	339.88
M99DO/32D	Dummy Trim	321.00

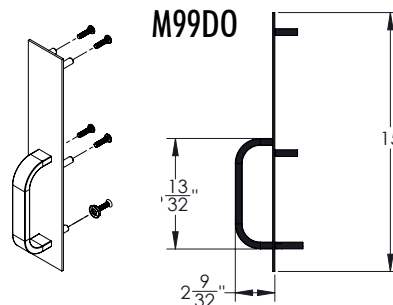
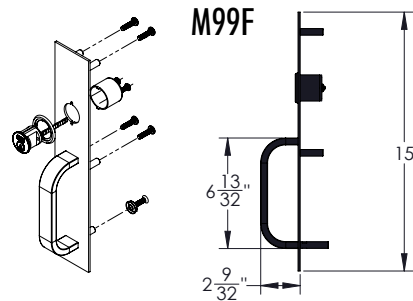

ELECTRIC LATCH RETRACTION

WITH SIMULTANEOUS DOGGING

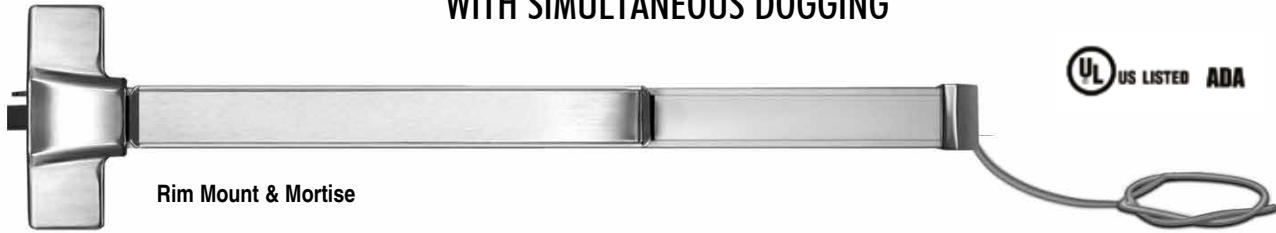

Rim Mount & Mortise

DEVICE SPECIFICATIONS	
ER	Electric Latch Retraction with simultaneous dogging
For:	M9900
Operation:	Momentary or maintained latch bolt and push pad retraction. Automatic re-triggering of latch retraction
Voltage:	24VDC @ 450 mA activation, 180 mA continuous
EMC	2-station sequencer required for automatic doors only.
Monitoring Available	Latch status and REX output available

MARKS #	DESCRIPTION	PRICE
HEAVY DUTY		
M9900ER	Electric Latch Retraction	2309.25
M9900ER-48	Electric Latch Retraction 48"	2396.18
M8800ER	Narrow Stile	2384.82

Exit Devices

EXIT ALARM



Door sign included, Bar sign optional

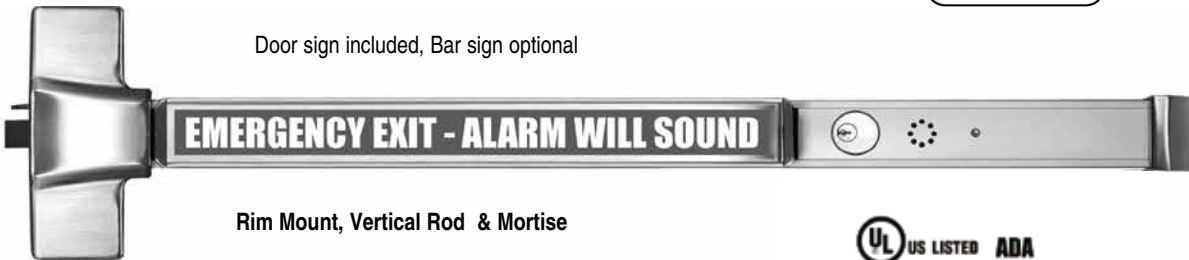

Rim Mount, Vertical Rod & Mortise

DEVICE SPECIFICATIONS	
EA	Exit Alarm, 9V battery powered
EB	Exit Alarm, 12-24V AC/DC input, 9V battery backup
For:	M9900
	<ul style="list-style-type: none"> • 100 dB alarm; visual and audible On/Off status: Armed - green LED blinks every 4 seconds, Alarm mode - red LED, Bypass - no LED • Remote status output • 15 or 60 second arming delay • 2 modes: Continuous alarm with manual key reset; Automatic re-arm 2 minutes after door closes with any manual key reset before 2 minutes.
Options:	<ul style="list-style-type: none"> • Push pad sign • 6, 10 & 20 minutes alarm; 1 or 5 second re-arm delay • Remote access control, arm, disarm inputs • REX and latch status outputs

MARKS #	DESCRIPTION	PRICE
HEAVY DUTY		
M9900EA	Exit Alarm 9VDC	2556.60
M9900EB	Exit Alarm 9VDC w 12/24 AC/DC Input	2719.06

ELECTRIC DOGGING



Rim Mount, Vertical Rod & Mortise

DEVICE SPECIFICATIONS
<p>DG Electric Dogging (failsecure) M9900, When energized by optional built-in or remote switch manual, depressing the pushpad, causes the pushpad and latch to remain retracted (unlocked) providing push-pull door operation. When de-energized or signaled by a fire alarm, the pushpad and latch are released.</p> <p>Voltage: 170/100 mA @ 12/24VDC</p> <p>Monitoring Available: Latch status and REX output available</p>

MARKS #	DESCRIPTION	PRICE
HEAVY DUTY		
M9900DG	Electric Dogging, Fail Secure	2719.01
Options for Parice		
P6-Rex	Request to Exit	62.00

DELAYED EGRESS



Rim Mount, Vertical Rod & Mortise

DEVICE SPECIFICATIONS
<p>DE Wall mount delayed egress controller with keypad and electrified exit device, M9900, M9900VR</p> <p>Example: M9900F/32D-DE</p> <p>DEK Keypad controller with redundant key switch capable of all keypad control features</p> <p>602RF 1 Amp power supply</p> <ul style="list-style-type: none"> User PIN codes may be assigned to 1, 2 or all control functions. Reset, sustained bypass and momentary bypass (RES) Audible alarm voice release time, warning or safety message Visual display countdown, locked/unlocked, egress executed 15 or 30 second exit delay, 1 or 2 second nuisance delay 2 minutes <p>Monitoring Available: Latch status available</p>

MARKS #	DESCRIPTION	PRICE
HEAVY DUTY		
M9900DE	Delayed Egress	6630.50
M9900KDE	Delayed Egress w Keyswitch	7097.88
M9900VRDE	Delayed Egress	6931.70
M9900VRKDE	Delayed Egress w Keyswitch	7366.00

M9900 LITE

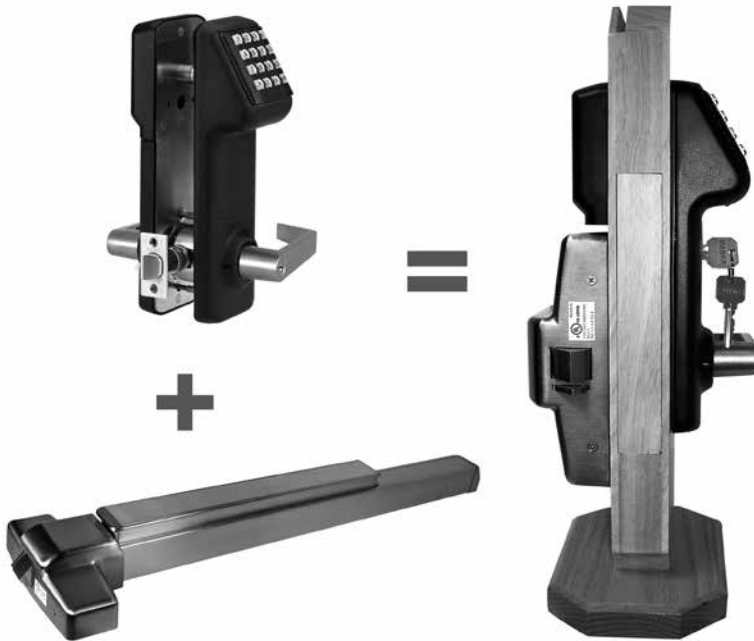

Adapter plate included

IQ7LITE

IQ7 LITE Rim Exit Device Interface Specifications

Door Thickness: 1-3/4" standard; For thicker doors, Consult factory

Handing: Non-handed

Key Override: 1-1/8" Mortise cylinder, 6 pin w/2 keys

Clutch: The "Clutch" for trouble free service

M9900

- **Doors:** 1-3/4" thick standard.
- **End cover:** Flush mounted beveled "Panic Protector" design.
- **Strike:** Roller strike.
- **Rail Assembly:** Extruded Aluminum, 32D finish.
- **Dead latch Bolt:** Stainless Steel 3/4" throw.
- **Dead latch Bolt:** Stainless Steel 5/8".
- **Dogging feature:** Allen Key (M9900)
- **UL listed:** For "Panic Hardware" and Fire Rated Model 3 hour fire doors up to 38" x 86".
- **ANSI:** ANSI 156.3 (2001), requirements for Grade 1.
- **3 Hour Fire Rating**
- **Finish:** 32D

MARKS #	FUNCTION	PRICE
M9900LITE	Rim Panic with IQ7LITE	1844.82

ARCHITECH™ SERIES NETWORK LOCKS

Ideal access control solution; elegantly blending advanced wireless access control convenience within any decor, in attractive, infinitely customizable designer locking form, in choice of trims and finishes.



N90L - Ideal for School and Campus



Back

Features

- 5000 Users, 500 Scheduled Events & 40,000 Event Audit Trail
- Surface-Mount or Mortised - in Electronics and Battery Pack
- Lock available in Mortise and Cylindrical versions
- Real Time Clock - Uses 4 AA Batteries – 3 to 4 year battery life
- Operated via access card, fob, key fob etc
- DL-Windows Software for programming
- USB Radio Key Programming Method or Via Networkx Gateways
- Manual Card Enrollment Option for Quick Installation
- Wireless programming range: up to 20 ft. from lock
- Easily, securely networked via 802.11 or ethernet, spanning a few or thousands of doors, in one building, a campus or multiple sites in an enterprise (also available in standalone model)
- Emergency LocDown Keyfobs & Flashing Strobe Indicator, Available
- Programmable Lockdown/Unlock Privileges
- Cylindrical ArchiTech Locks neatly, quickly retrofit any standard door lock, with easy surface mount electronics, for use in all applications - Including wood and metal doors, for new and existing applications
- Customizable oval or square Access ID Reader, in black or silver and three levers to choose from - American 195, Crescent 295 & Titan 495
- Future-Proof Multi-Technology Access ID Credentials Replace Cumbersome Keys – HID® Prox, Mag Stripe, Smart Cards, PIV, keyfobs and remote buttons
- Powered by 4 off-the-shelf AA Batteries. 3 to 4 years, typ.
- Flexible System Monitoring, Control & Programming – Program locally using a USB Gateway or remotely across a wireless network (using free Alarm Lock DL-WINDOWS Windows- based software). Or, in Real-Time Enterprise platforms, using either Continental Access CA4K®, Lenel® OnGuard® or support via Software House® Connected Partner Program®

Specifications

- ANSI / BHMA Grade 1 Certified, UL Listed 3 Hours
- Includes standard lever rose hardware design
- Compatible with all 300+ optional architectural trim / lever or knob designs
- Stainless steel latch, 2-3/4" backset
- Auto-Reverse lock body tested to 6 million cycles
- Lock Body - Self cleaning long life motor
- Door closure monitor / electronic deadbolt monitor
- Key override standard or high-Security
- Optional integrated door position indicator switch

ARCHITECH™ SERIES NETWORK LOCKS

ArchiTech Series Cylindrical Locks

PRODUCT	PRICE
Cylindrical	
N90S1195F26D	2259.53
N90S2195F26D	2259.53

The standard list price of a standard ArchiTech Cylindrical Lock is \$880 (American Lever, SCI Keyway) – Add \$100 ea. for iClass, or Bluetooth®. Add \$50 for keying

N90L - IDEAL FOR SCHOOL & CAMPUS	PRICE
Cylindrical	
N90L1195F226D	2387.91
N90L2195F226D	2387.91

ArchiTech Cylindrical Lever & Lever Prep Options

OPTIONS	CODE	195	295	495	FINISH	ADD-ON
Yale Conventional	F7	Yes	No	No	26D, 10B	30
Sargent Conventional	F8	Yes	Yes	No	26D, 10B	30
Corbin Conventional	F9	Yes	Yes	No	26D, 10B	30
Corbin 6-Pin IC	F12	Yes	Yes	No	26D, 10B	30
Corbin 7-Pin IC	F12	Yes	Yes	No	26D, 10B	30
Yale 6-Pin IC	F14	Yes	Yes	No	26D, 10B	30
Yale 7-Pin IC	F15	Yes	Yes	No	26D, 10B	30
Schlage 6-Pin IC	F19	Yes	Yes	No	26D, 10B	30
Sargent IC	F20	Yes	Yes	No	26D, 10B	30
Medeco IC (Large Format)	F21	Yes	Yes	No	26D, 10B	30

Choice of Levers – Cylindrical Models



195 – American Lever

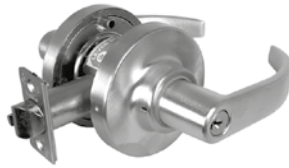

295 – Crescent Lever



495 – Titan Lever

No up-charge for Marks (Best) SFIC. Specify "RF" for SFIC

*Note: Please consult factory for availability of other finishes. Round rose plate only available with cylindrical version (3.5" diameter). IC core models: tail piece included, core not included.

How to order ArchiTech Cylindrical Models

Base distribution cylindrical model P/N scheme

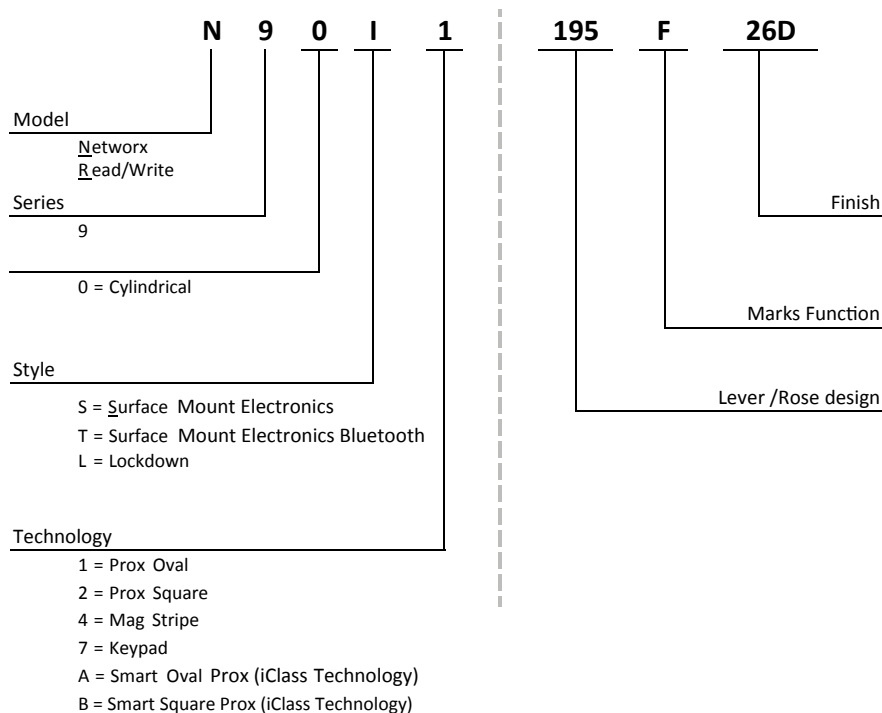

ArchiTech Series Network Locks

ARCHITECH™ SERIES NETWORKX LOCKS

ArchiTech Series Mortise Locks



Infinite custom models available for ArchiTech mortise versions. Consult factory for ordering assistance.

ArchiTech Mortise Lockset Options

OPTIONS
Insert (N91) or Surface Mount (N95) Electronics
Oval, Square or Mag Reader
Bluetooth and iClass Available
Choice of lever and rose plate
N95S – Surface Mount Electronics; oval, square & swipe (mag) reader available
N95I – Insert electronics; oval & square reader available
N95J – Insert electronics; Bluetooth, oval & square reader available
N95T – Surface Mount Electronics; Bluetooth, oval, square & swipe (mag) reader available

PRODUCT	PRICE
Mortise	
N95S2RX92FD26D	2824.41
N95S1RW92FD26D	2824.41

Lever and Rose Options – Mortise Models

LEVERS	Stanhope Lever 44	Copa Lever 031	Brompton Lever 55	Monaco Lever 57 Specify handing
	Towne Lever 72	Maxwell Lever 77	Omni Lever 78	Plaza Lever 82 Specify handing
	Dayton Lever 83 Specify handing	Crescent Lever 86	American Lever 92	Titan Lever 96

ROSES	RR: 2-9/16" dia.	
	RW: 2-9/16" dia.	
	RQ: 2-1/4" dia.	
	RS: 2-1/4" dia.	

No up-charge for Marks (Best) SFIC. Specify "RF" for SFIC

*Note: Please consult factory for availability of other finishes. Round rose plate only available with cylindrical version (3.5" diameter). IC core models: tail piece included, core not included.

RX: 2-1/2" sq.	RK: 2-1/2" sq.	RL: 1-1/2" sq.
Wrought	Forged	

ArchiTech Series
NetworkX Locks

Functions for Mortise Locks

CODE	FUNCTION	DESCRIPTION
FD	APARTMENT	Latch by lever either side except when outside locked by stop-button or projected deadbolt. Latch deadlocked by auxiliary latch or deadbolt & latch by key outside. Deadbolt by turn piece inside. Inside knob/lever retracts latch & deadbolt simultaneously, leaving outside locked.
E	STOREROOM	Latch by lever inside, key outside. Outside lever always rigid. Auxiliary latch deadlocks latch. Inside always open.
AD	AUTOMATIC DEADBOLT	Latch deadlocked by deadbolt automatically when door closes. Deadbolt & latch by key or redential outside. Inside lever retracts latch & deadbolt simultaneously, leaving outside locked.

ARCHITECH™ SERIES NETWORK LOCKS

How to order ArchiTech Mortise Models

Base distribution cylindrical model P/N scheme

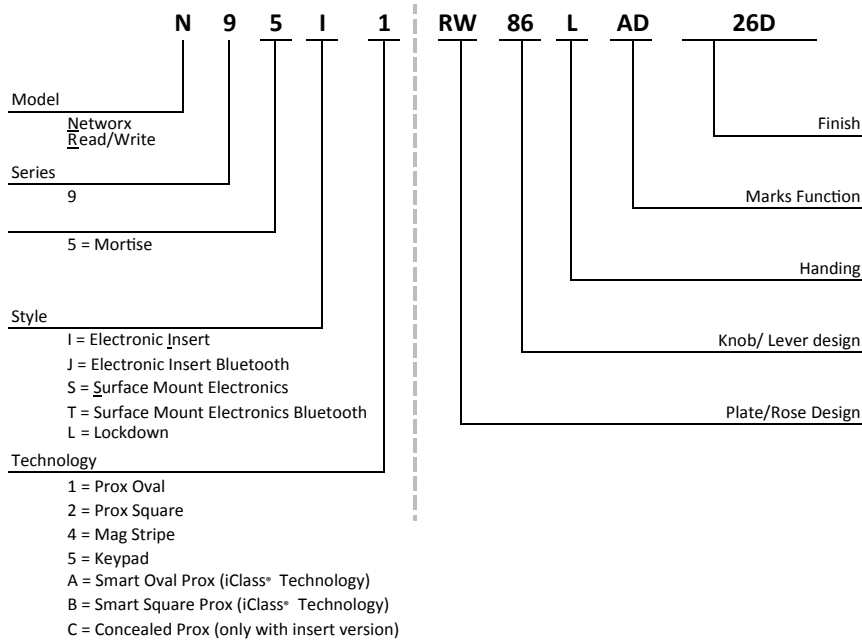

SPECIAL ORDER

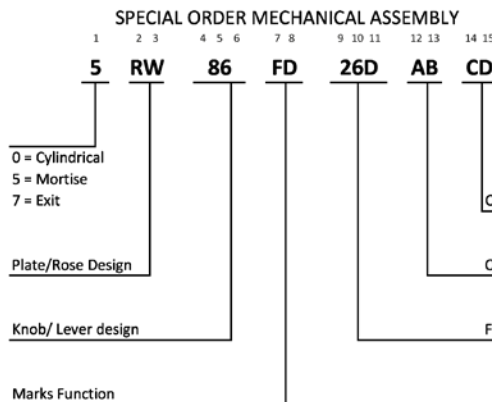
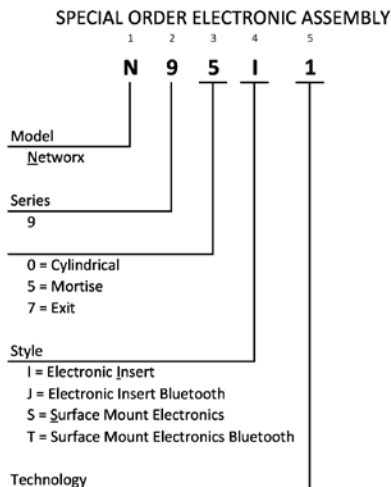

- 1 = Prox Oval
- 2 = Prox Square
- 3 = Mag Stripe Oval
- 4 = Mag Stripe Square
- 5 = Keypad Oval
- 6 = Keypad Square
- 7 = Keypad Prox Oval
- 8 = Keypad Prox Square
- 9 = Keypad Mag Stripe Oval
- 0 = Keypad Mag Stripe Square
- A = Smart Oval (iClass® Technology)
- B = Smart Square (iClass® Technology)
- C = Concealed Prox

ARCHITECH™ SERIES NETWORKX LOCKS

ArchiTech™ Series Networkx Locks Parts and Accessories

PRODUCT	DESCRIPTION	PRICE
AL-IME2	Ethernet connected gateway w/AC adapter to plug into standard wall outlet. Version 2 allows use of expander	1219.63
AL-IME2POE	Power Over Ethernet, plus hardwire gateway interface capability. No AC Power required. Version 2 allows use of expander	1476.40
AL-IME2EXP	Wireless Expander designed to expand the coverage area of version 2 gateways. AC power required. Up to 7 expanders per version 2 gateway	641.91
AL-IME2-PIE	Plug-in wireless expander, as above – Plugs into standard AC outlet	641.91
AL-PRE2	Prox card enroller – HID and iClass	1514.91
AL-NSM	Networkx Signal Meter	760.02
AL-NSG	Networkx Signal Generator	616.24
AL-PB	ArchiTech Power Booster	3327.67
ALHID1326	Proximity Access Cards 100 Per Box	847.06
ALHID1391	MicroProx Tag 10 per box	210.55
ALHID1346	Proximity keyfob 10 per box	302.98

Use the iLock® App to unlock your Networkx ArchiTech™ Bluetooth® Series Door Lock in seconds!



Introducing iLock, the easy smartphone mobile solution for unlocking your Trilogy® ArchiTech Bluetooth Series Designer Access Control Locks from any smart device without the need to carry cumbersome ID cards or keys. Password protected access is secure through the use of Bluetooth LE® and proprietary encryption. Additionally, an optional feature can be utilized, requiring a password for each unlock request.

The Key is Your Smartphone & More Secure Technology

Any Smart Device can be the Access Key: Much more than an ID card displayed on your smartphone, for your security, ArchiTech & its iLock App are



entered on their phone App.

wirelessly linked together, each supplying its portion of stored encrypted data to provide secure access without a key, fuss or worry, ensuring user identities. A unique combination of convenience and cloneproof peace of mind, the ArchiTech platform uses universally-compatible Bluetooth LE technology, so they can use any smart device to unlock ArchiTech on your door(s); and do so from afar, at a comfortable, customizable range of up to 30 feet away. For even greater security users can add an optional passcode,

ArchiTech Series
Networkx Locks

iLock App is available from both iTunes and the Google Play Store



MARKS USA

AMITYVILLE, N.Y. 11701

www.marksusa.com

DISTRIBUTED BY:

800-645-9445 • www.marksusa.com • salesinfo@marksusa.com

Marks USA is a Division of NAPCO Security Technologies, Inc. (NASDAQ: NSSC) • NAPCO • Alarm Lock • Continental Access • Marks USA
ArchiTech, LifeSaver, Survivor, Hi-Security, iQwik, LocDown Thinline and Unilock are trademarks of Marks/NAPCO. Other trademarks listed are properties of their respective companies.

ALA530A ©Marks USA, 7.2019