







**Montageanleitung
Tandem-Schwenkauszug
für 45er + 50er Hochschrank**

**Mounting Instruction
for 450mm and 500mm
Tandem pull-out**

- 2x 
- 1x 
- 2x 
- 2x 
- 1x 
- 1x 
- 1x 
- 1x 
- 2x 

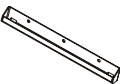
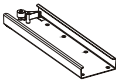
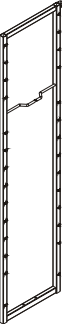
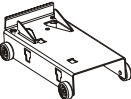

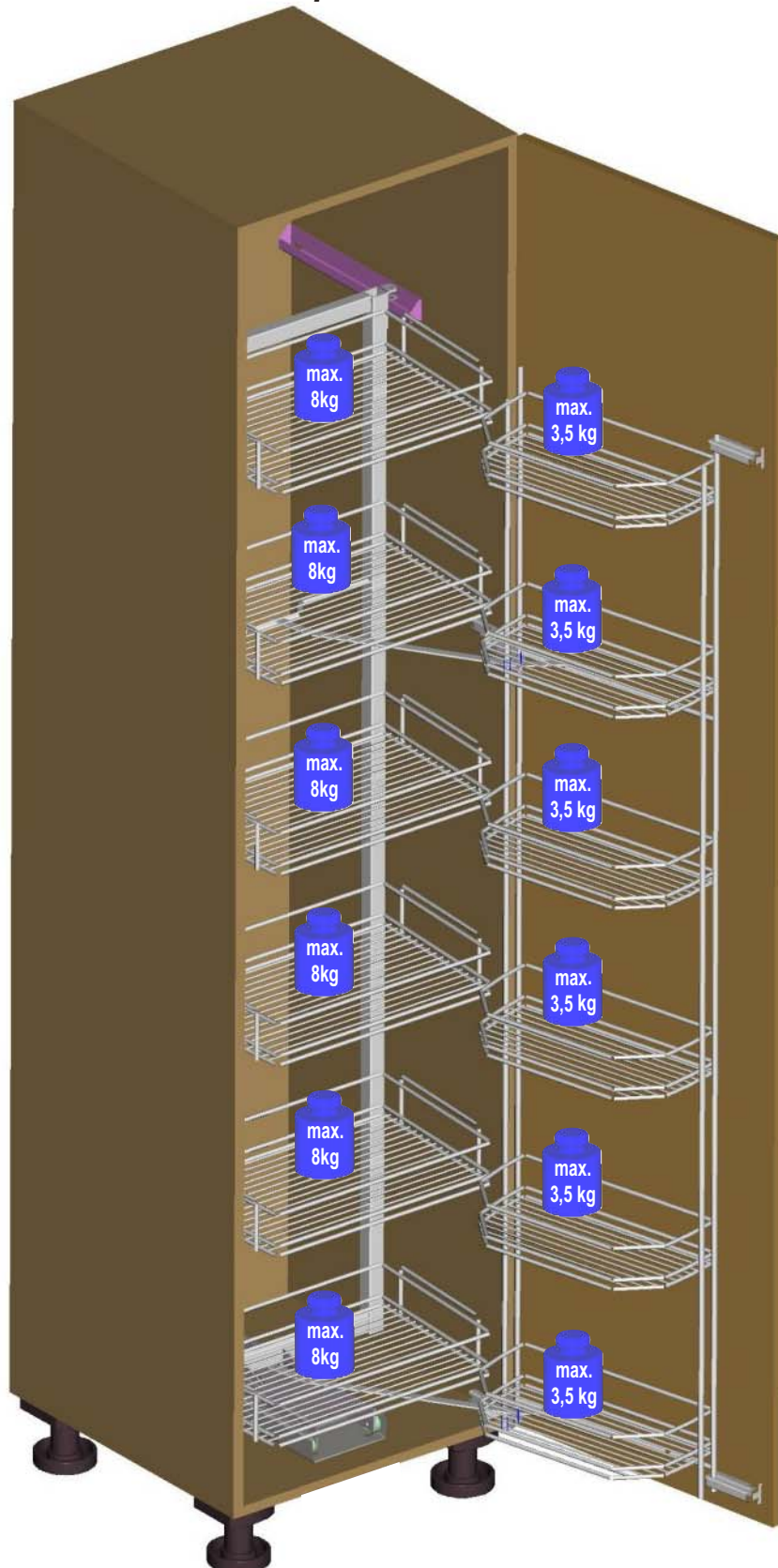
1



Vor dem Einbau muss der Schrank ausgerichtet und gegen Kippen gesichert werden.
Before starting with installing, make sure that cabinet is leveled and fixed against tilting.

1x

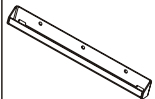

1x

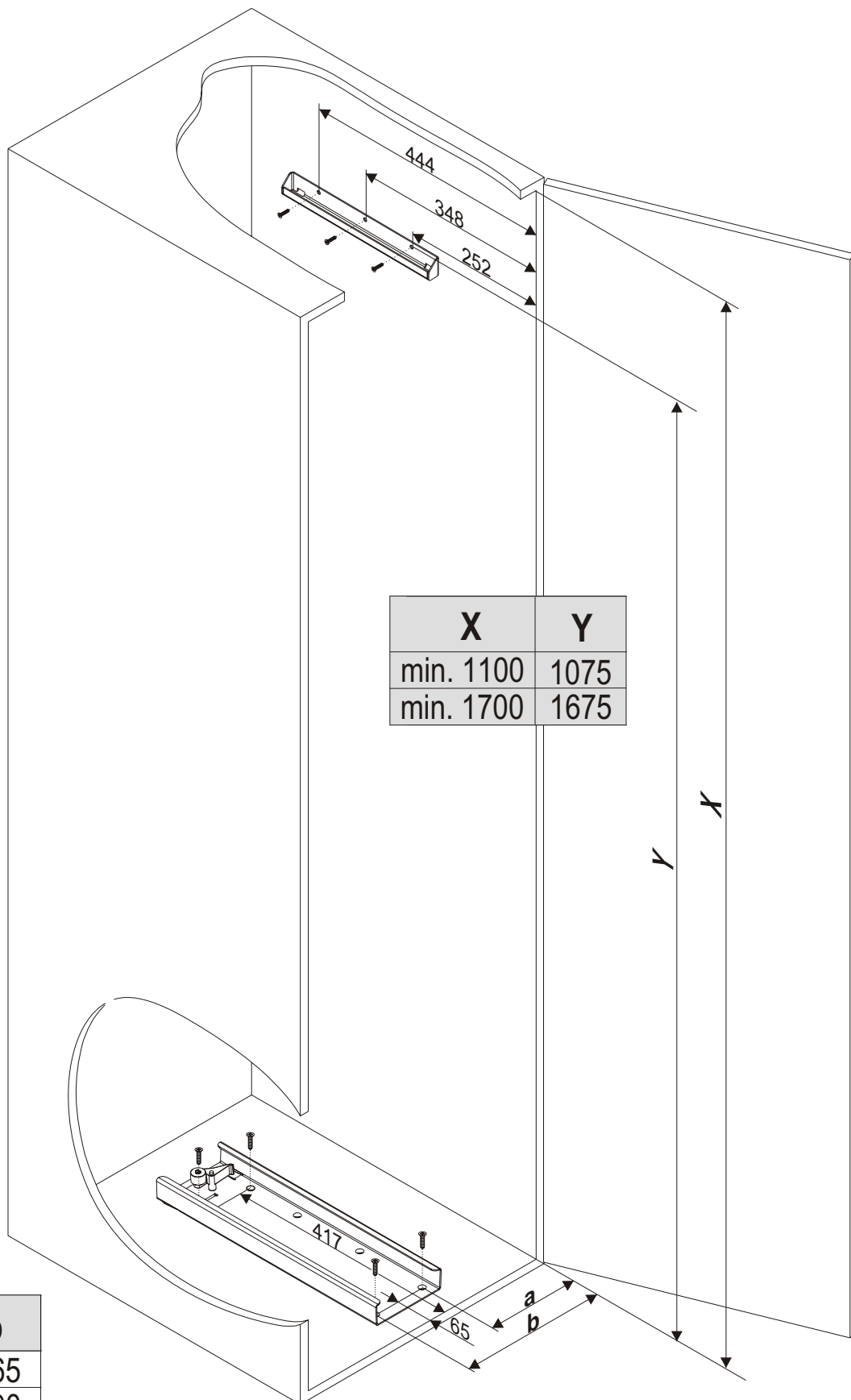
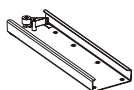

X	Y
min. 1100	1075
min. 1700	1675

	a	b
45er	169	265
50er	194	290

2

A Tür rechts
Door right

2x

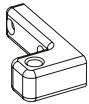

X	Z
min. 1100	625
min. 1700	1225

**Sollte auf Höhe des oberen
Lagers ein Türscharnier montiert
sein, so ist das Lager
entsprechend tiefer zu montieren**

*In case of top bearing is in same
hight as hinge, the bearing is
to move to the next possible
lower position*

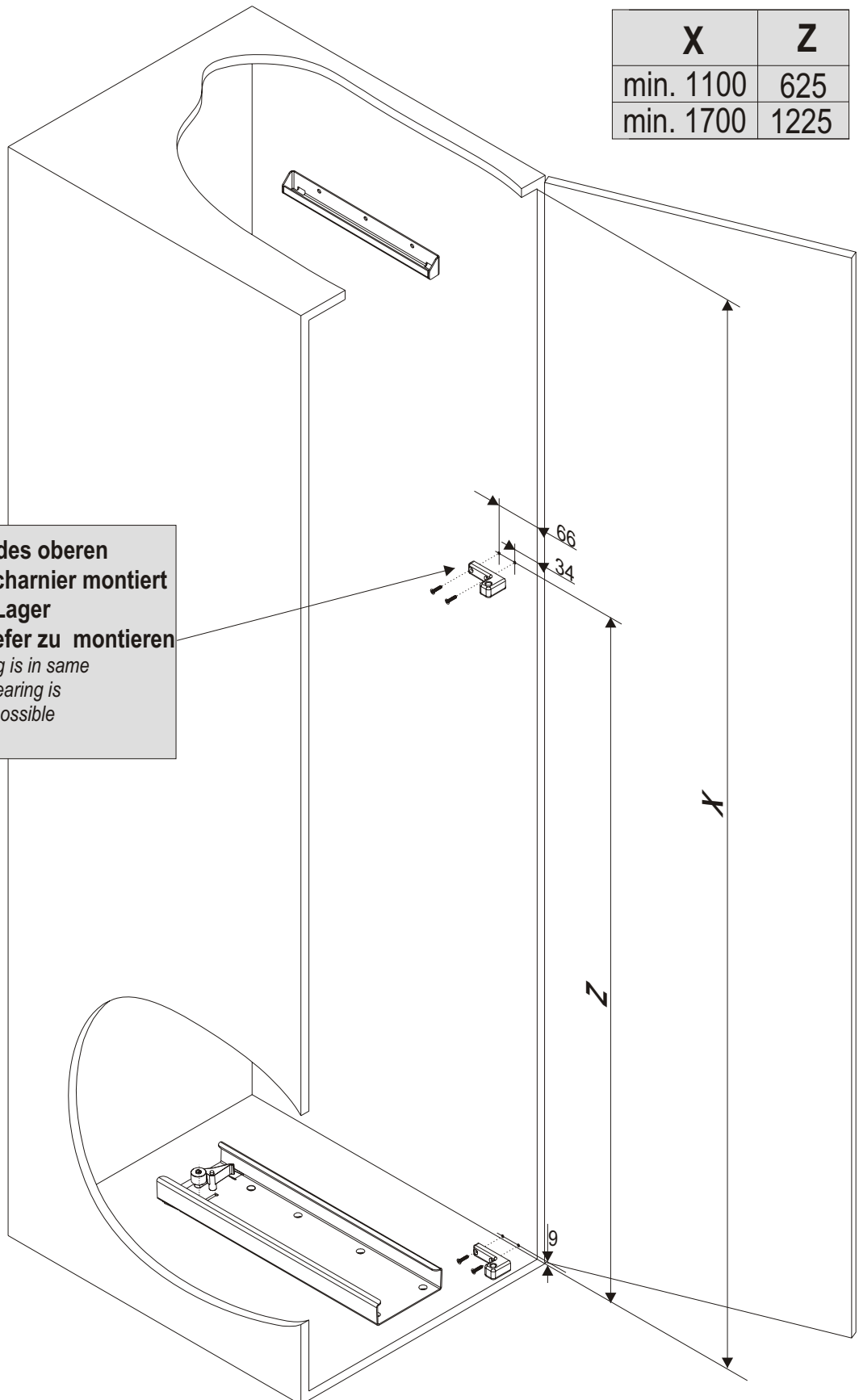

B Tür links
Door left

2x

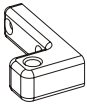

X	Z
min. 1100	625
min. 1700	1225

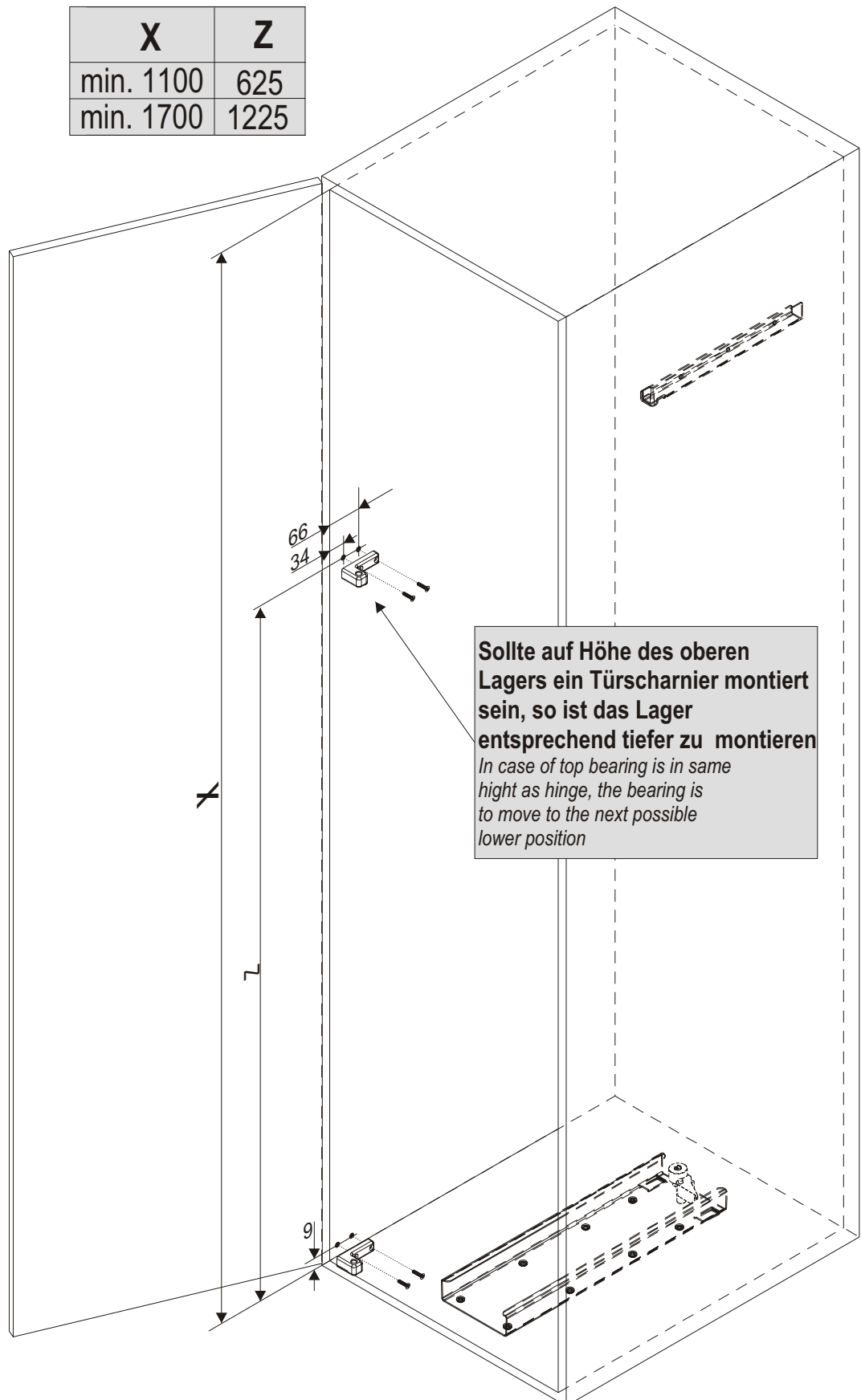

3

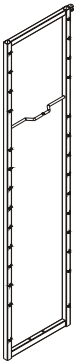
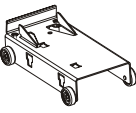
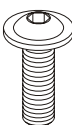
- 1x 
- 1x 
- 2x 

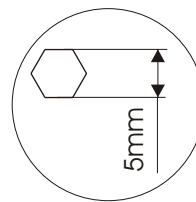
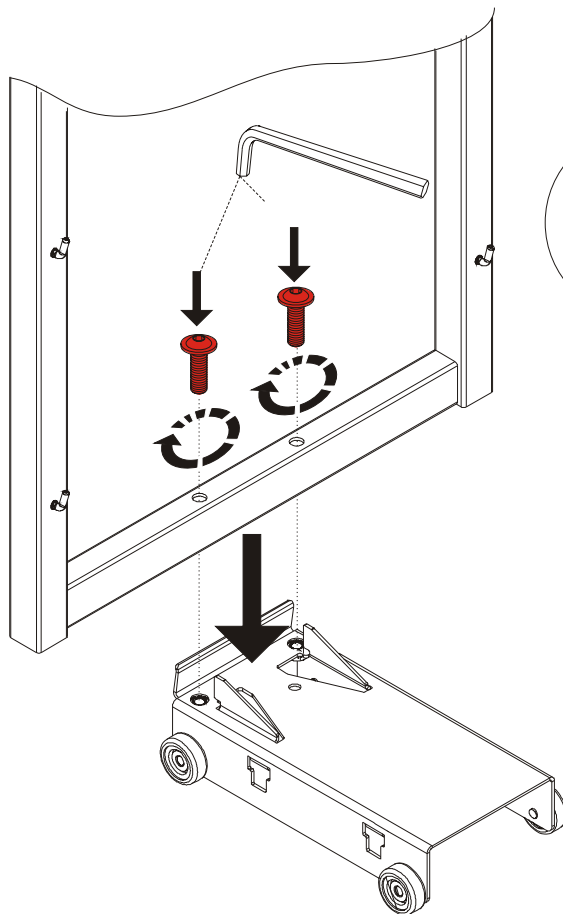
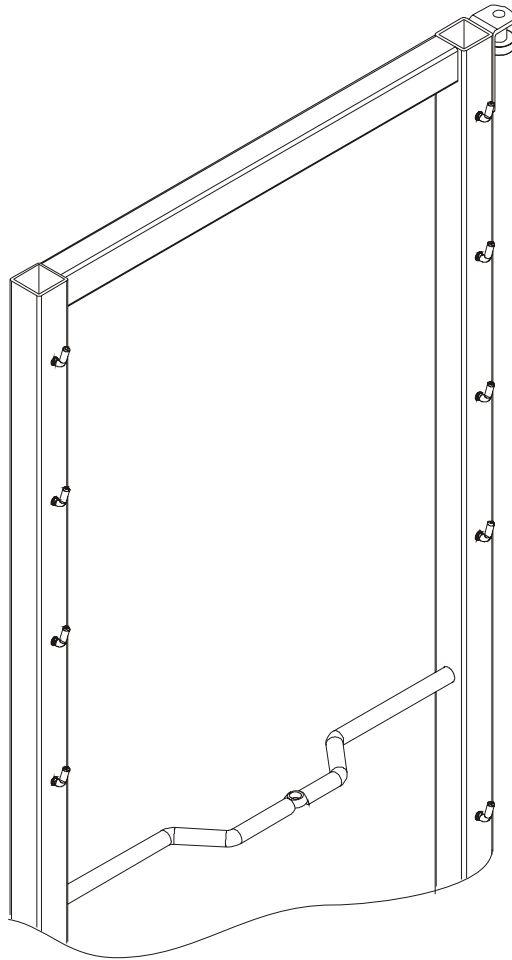

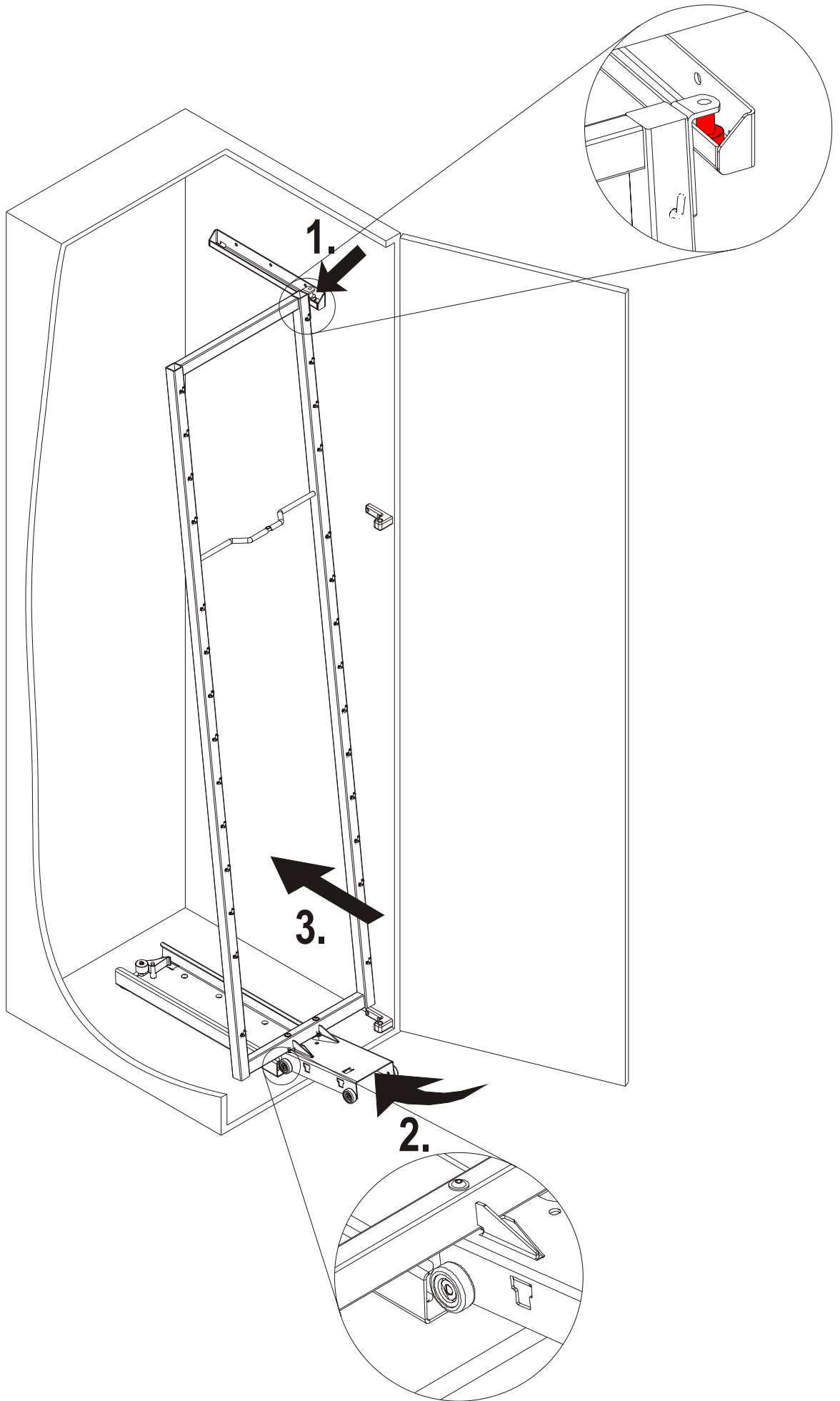

5

A Tür rechts
Door right

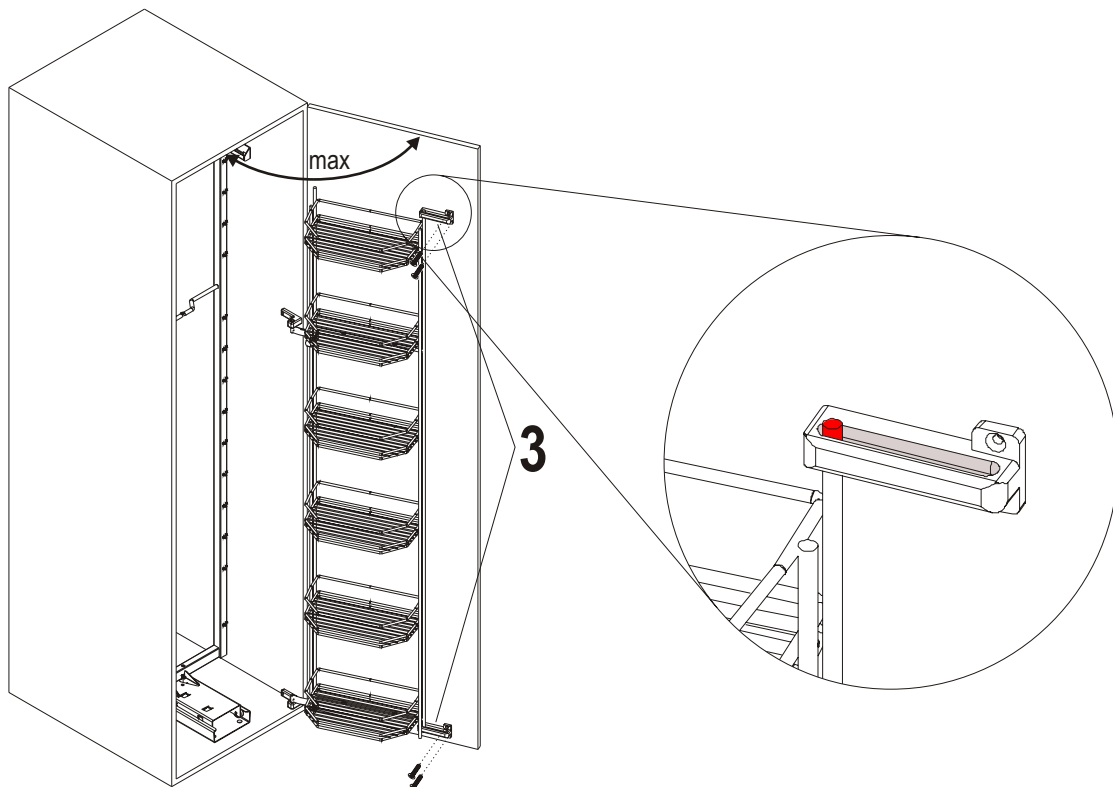
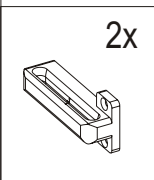
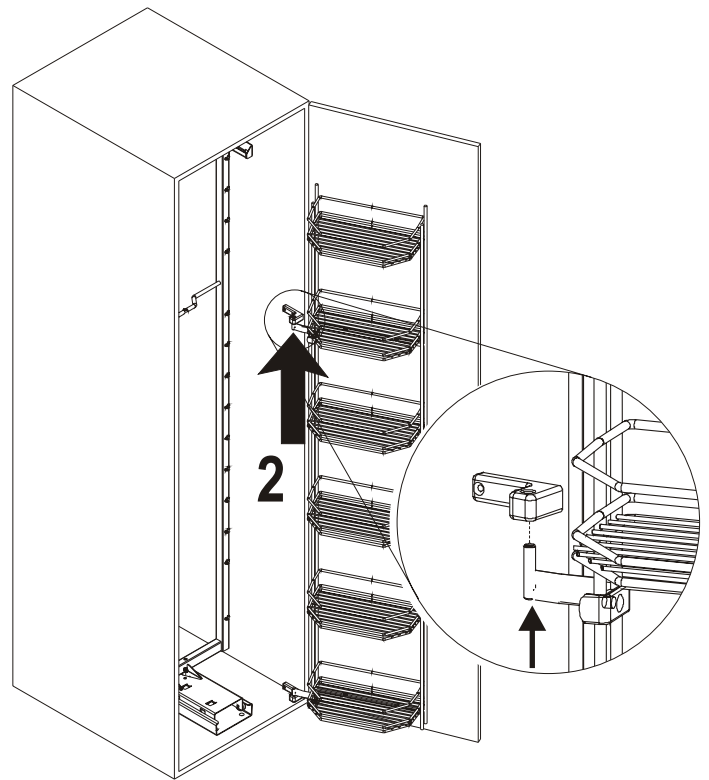
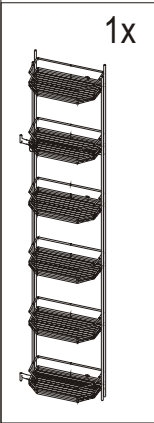
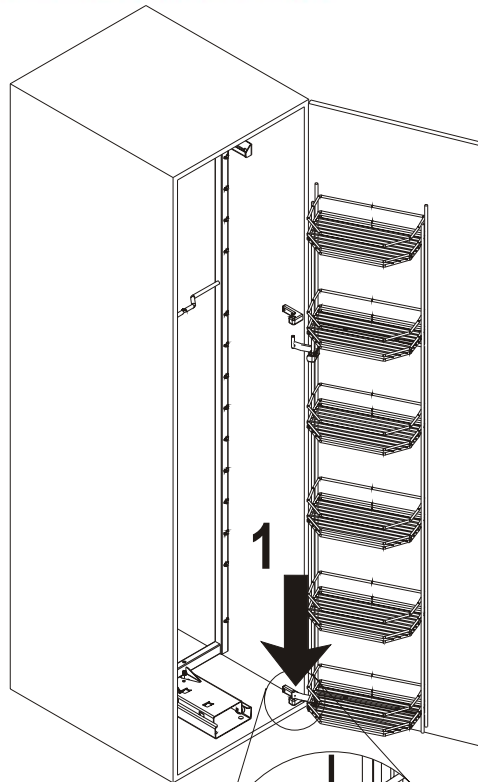

B Tür links
Door left

Anlieferzustand für
rechts scharnierte Tür
State at delivery

Links scharnierte Tür
Door left mounted

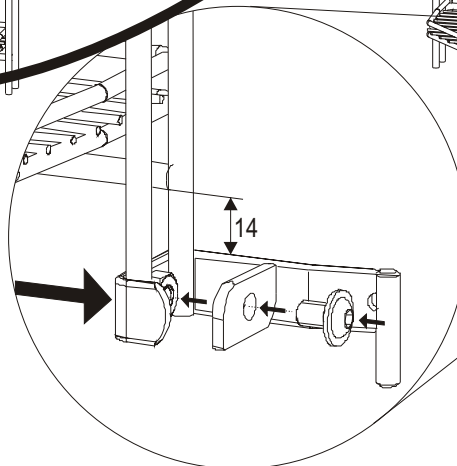
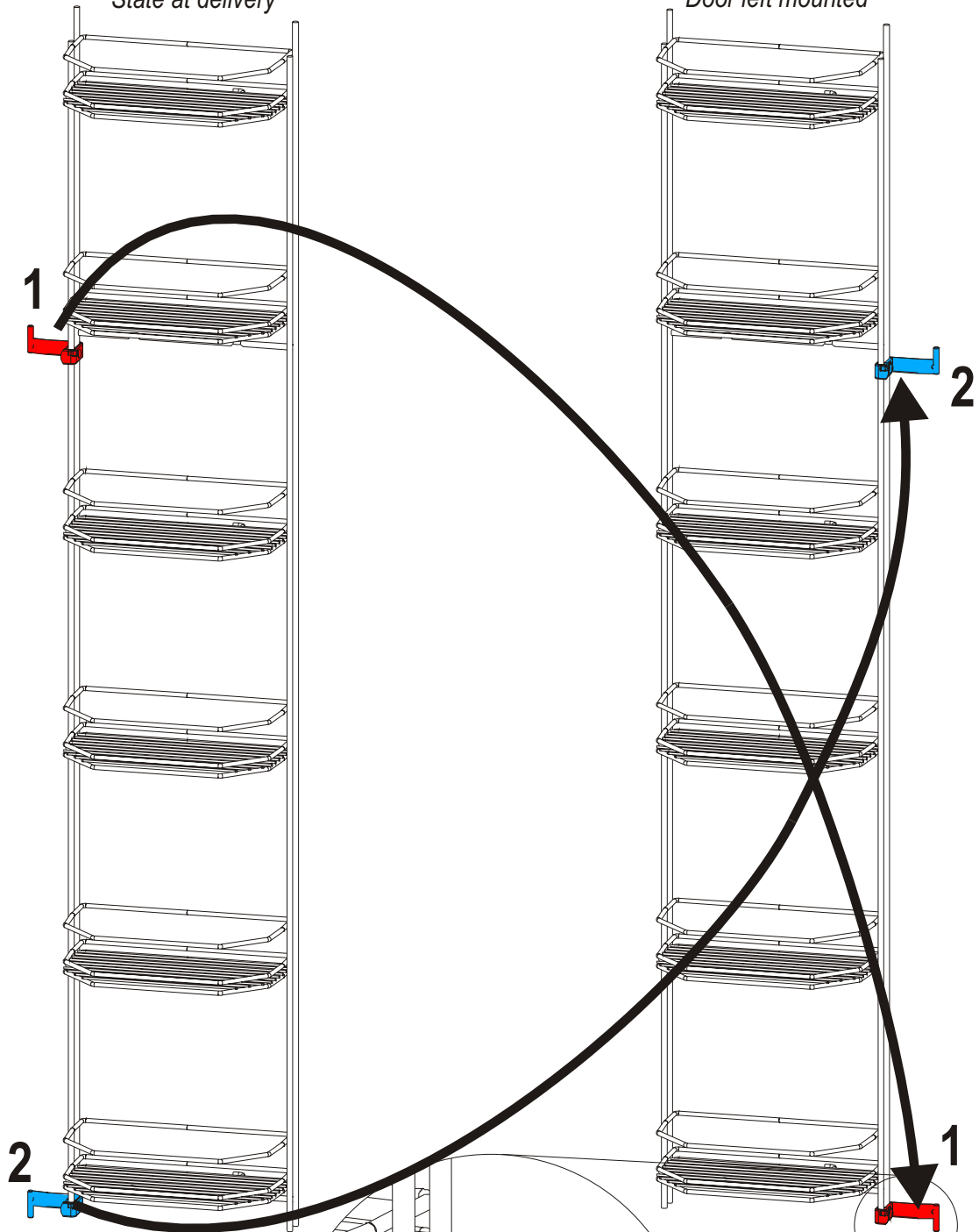

→ S. 7
p. 7



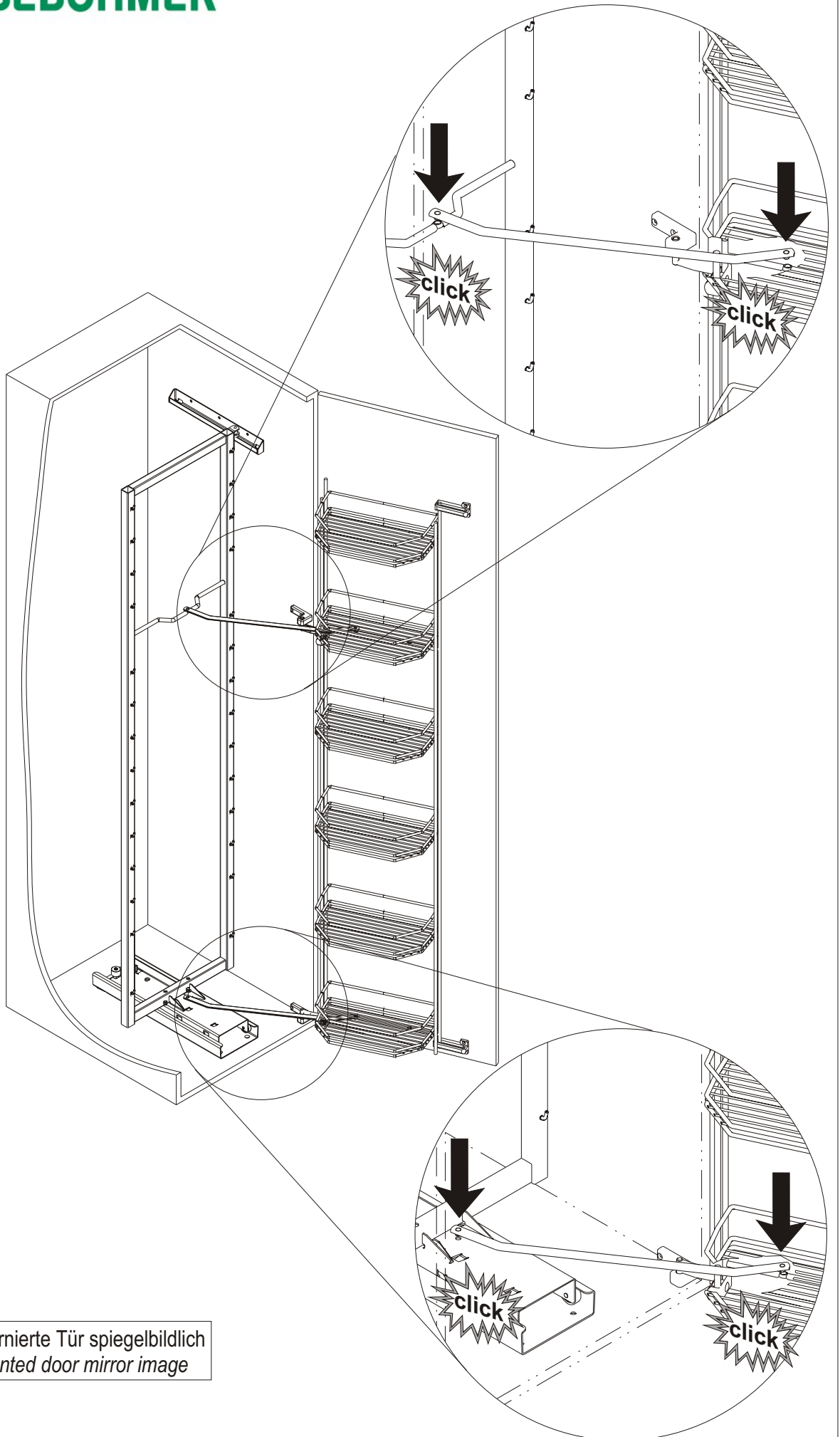
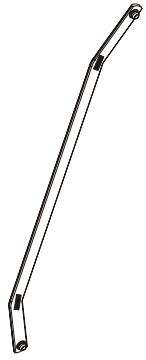

6

2x

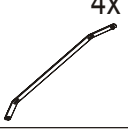
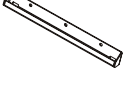
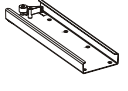
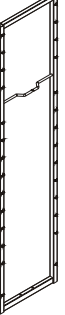
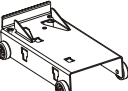

Für links scharnierte Tür spiegelbildlich
For left mounted door mirror image

7 Aufbau als Tandem-Depot
Installation as Tandem depot

- 4x 
- 2x 
- 4x 
- 4x 
- 2x 
- 2x 
- 2x 
- 2x 
- 4x 
- 8x40

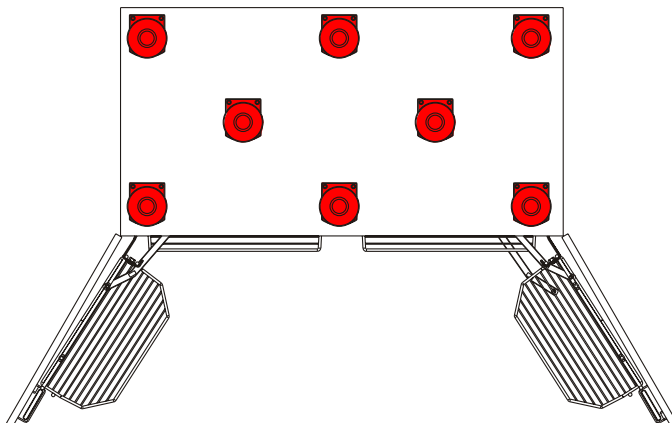
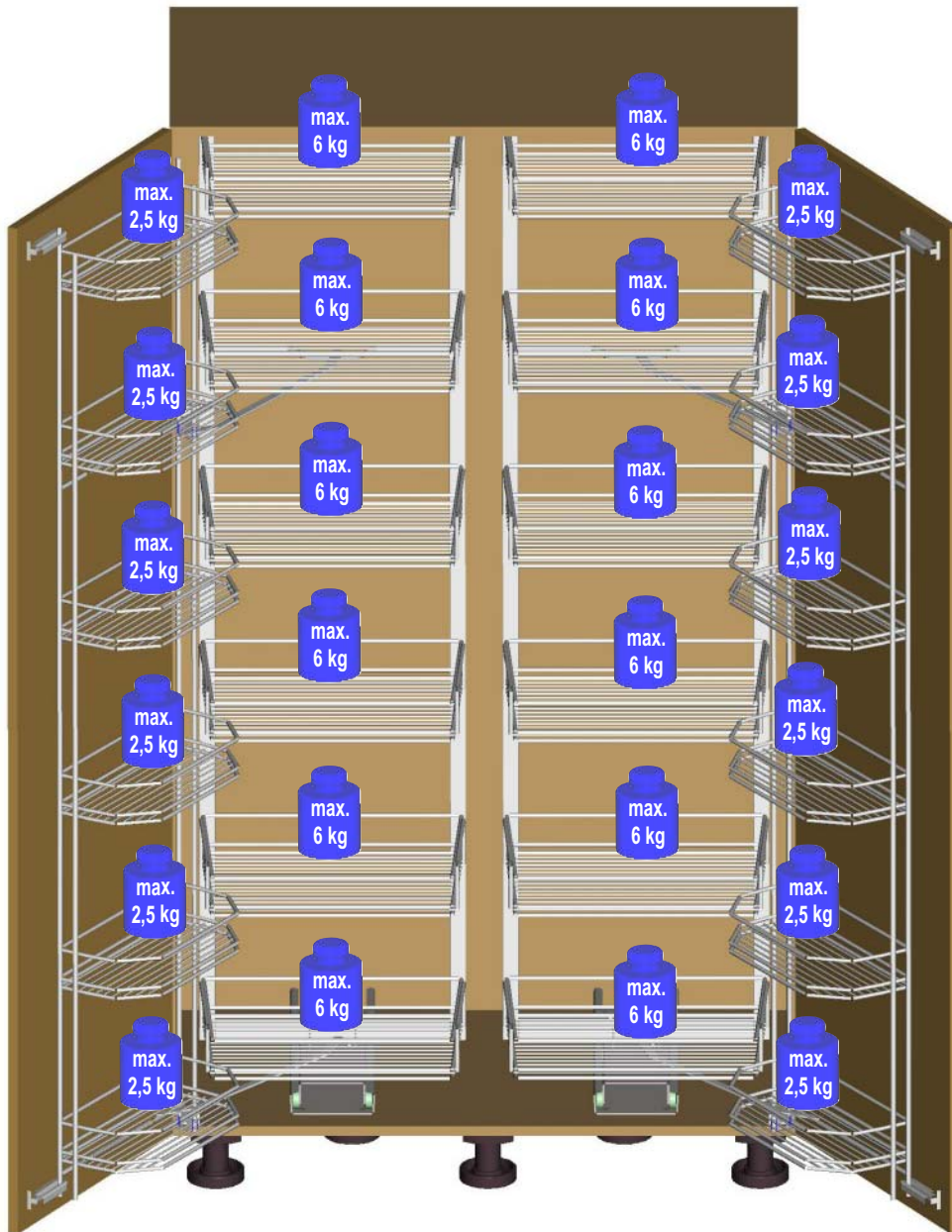

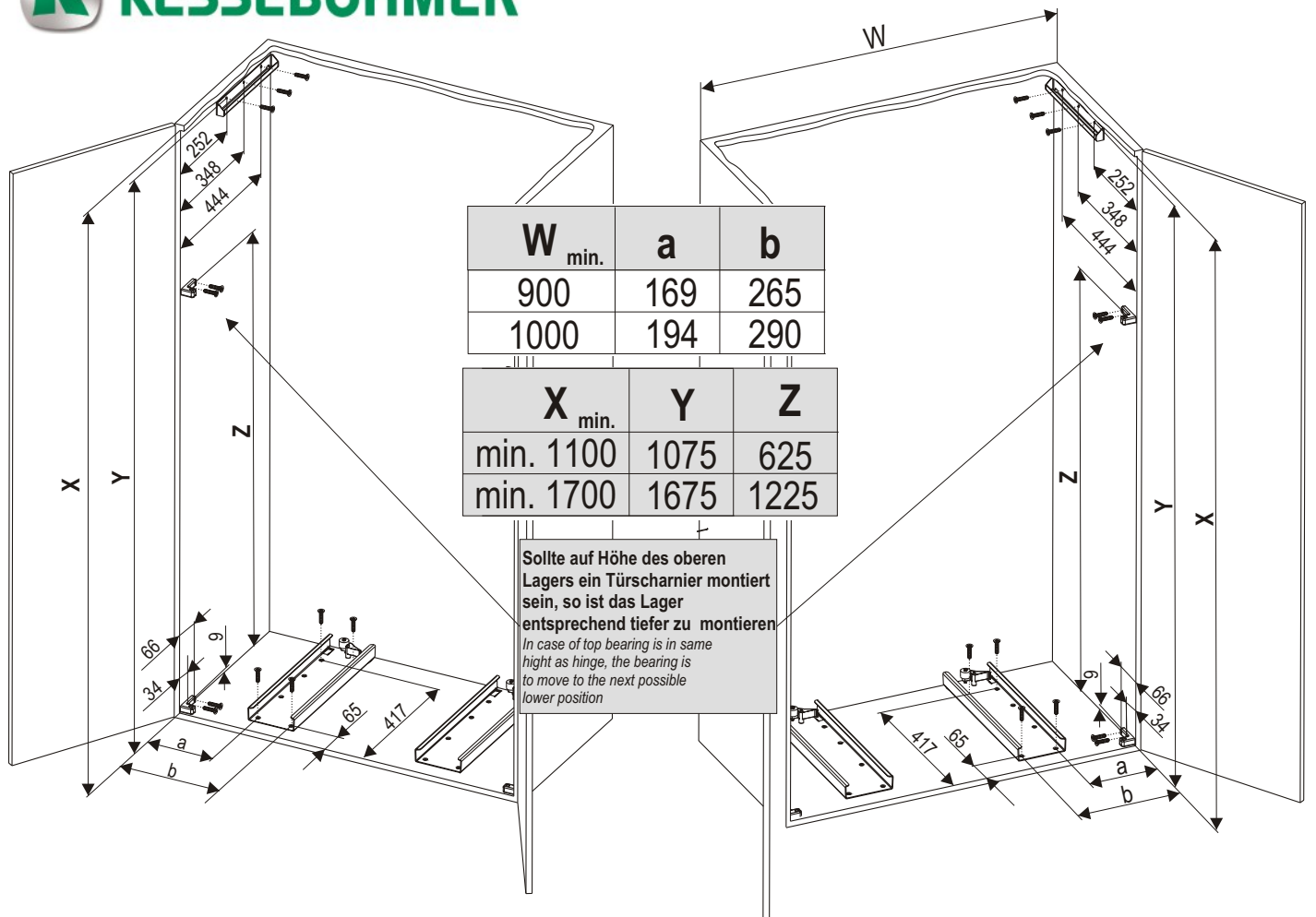

Anlieferungszustand für rechts scharnierte Tür
State at delivery

Links scharnierte Tür
Door left mounted

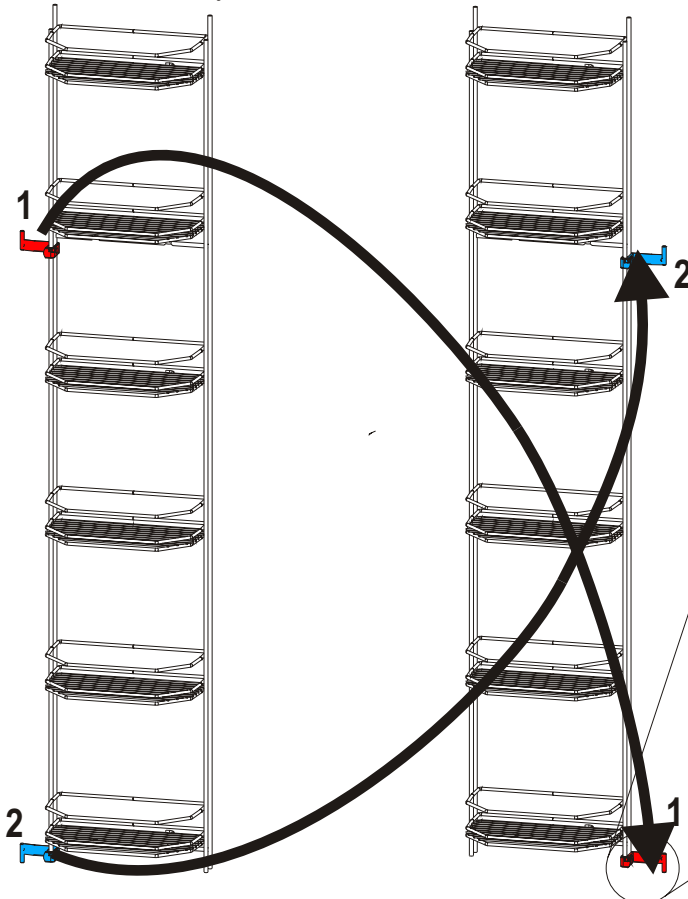
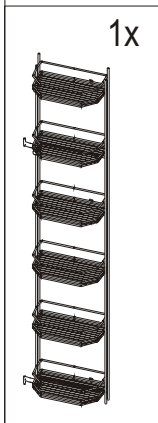

Anlieferzustand für
rechts scharnierte Tür
State at delivery

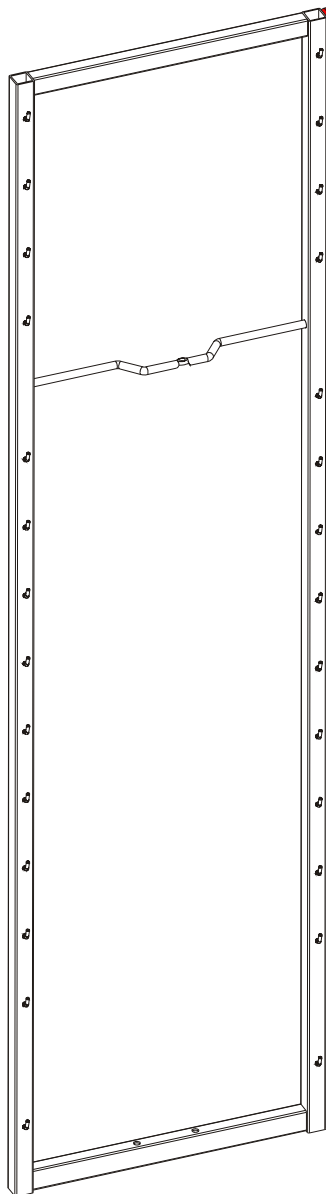

Links scharnierte Tür
Door left mounted

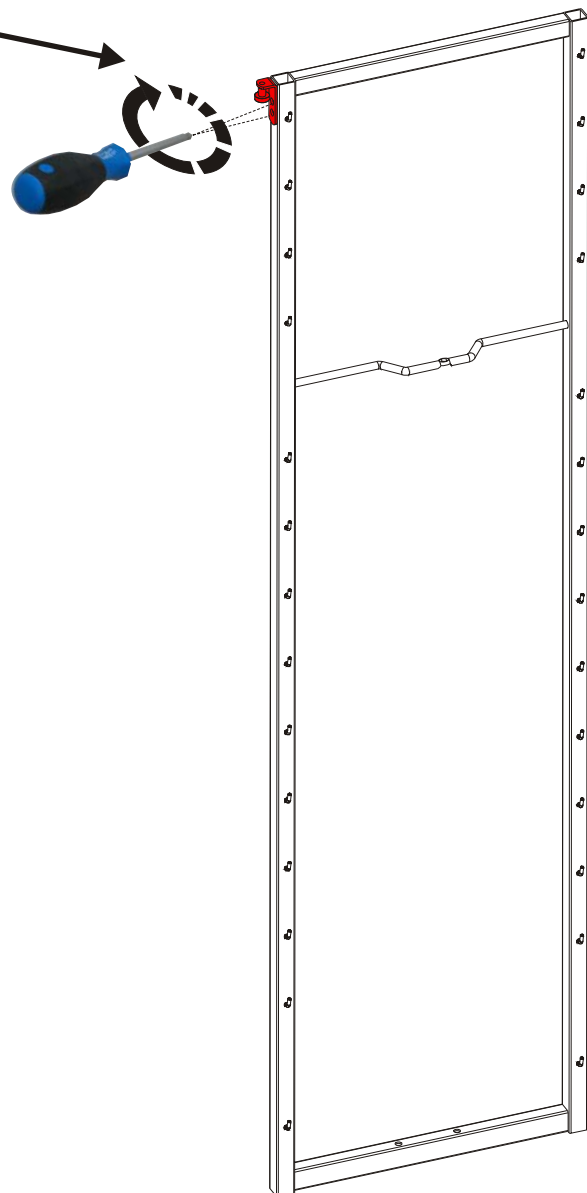

→ S. 5 - 7
p. 5 - 7