



Right hand opening shown



« Click Fixx » fixing system



Soft stop (optional)

Lemans II: better performance, easier to install.



Products features

- Easy to order, offered in complete set: hardware, post and 2 trays in a single box.
- Shelves available in maple/chrome or grey/chrome Arena Style.
- CARB certified melamine shelves with anti-slip coating.
- Suitable for frameless cabinets, as well as face frame cabinets.
- To avoid any protrusion with adjacent cabinet handles for example, Le Mans II pulls completely out with a 85 degree door opening angle.
- Available for right and left opening.
- 25kg (55lb) weight capacity per shelf.
- Soft stop can be ordered as an option
- Spacer to be ordered separately if required for face frame cabinet application (see mounting instructions).
- The shelves are easily height adjustable.
- Trays can be moved out individually and completely
- The restrictor is fixed underneath the shelf and attached to the arm. It allows to reduce the opening of the shelf of around 20% and then to avoid shocking with the adjacent appliances.



693630 Restrictor

Some solutions just make more of corner space than others!

Le Mans II combines optimal space utilisation with a clear overview and beautiful action. You can store a lot of pots, pans, plates and each one is always in easy reach.

No more space wasted, Lemans is the answer if you set store by efficiency combined with stunningly good looks!

Often imitated, never equalled!

Code	Description	Finish	Replaces
6930140150	Set Lemans II 450mm right	Maple and chrome	6920140150
6931140150	Set Lemans II 450mm left	Maple and chrome	6921140150
6932140150	Set Lemans II 500mm right	Maple and chrome	6922140150
6933140150	Set Lemans II 500mm left	Maple and chrome	6923140150
6934140150	Set Lemans II 600mm right	Maple and chrome	6924140150
6935140150	Set Lemans II 600mm left	Maple and chrome	6925140150
6930140100	Set Lemans II 450mm right	Grey and chrome	6920140100
6931140100	Set Lemans II 450mm left	Grey and chrome	6921140100
6932140100	Set Lemans II 500mm right	Grey and chrome	6922140100
6933140100	Set Lemans II 500mm left	Grey and chrome	6923140100
6934140100	Set Lemans II 600mm right	Grey and chrome	6924140100
6935140100	Set Lemans II 600mm left	Grey and chrome	6925140100
6930100	Spacer grey for face frame cabinets	Grey	
693630	Restrictor	White	
693702100	Soft stop right	Grey	
693703100	Soft stop left	Grey	

With the new version, you don't need to order an extra post as they are included in the box.

Installation dimensions requirements: see next pages.
Usage of #6930100 , see mounting instructions.

Technical informations

Hardware mounting



Arms mounting on the post



Arms mounting on the standard

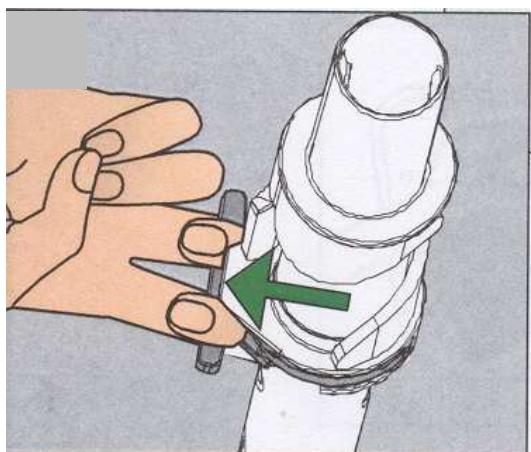

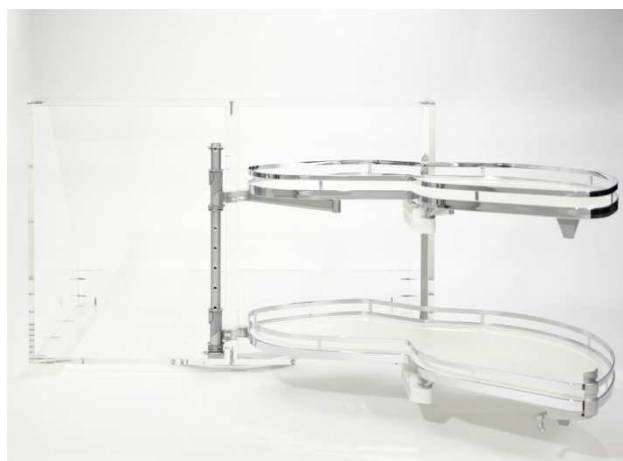

Height adjustment by pulling on the spring trigger.



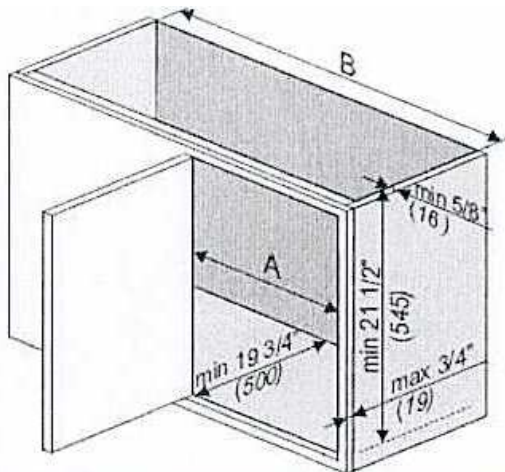



Here is the completed system ready to use.

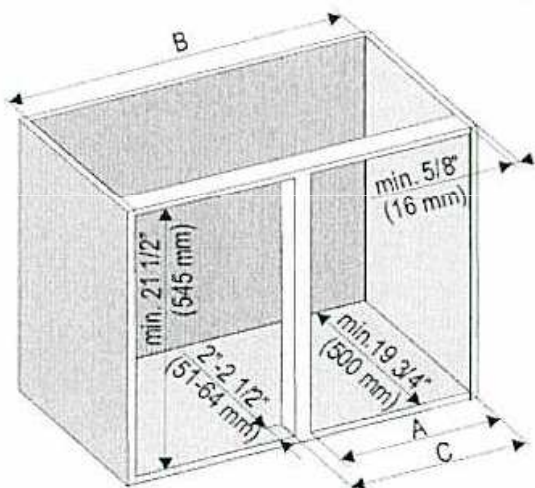

	A	B
 LeMans 45	min. 16 1/8" (410 mm)	min. 32 1/4" (820 mm)
 LeMans 50	min. 17 3/4" (450 mm)	min. 36 1/4" (920 mm)
 LeMans 60	min. 21 1/4" (540 mm)	min. 38" (965 mm)



Face frame cabinets
Without center stile

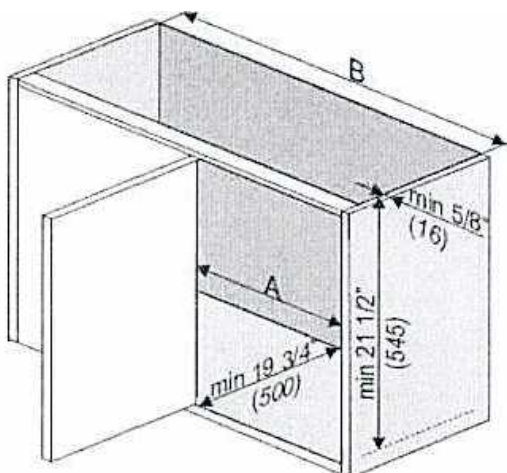

	A	B	C
 LeMans 45	min. 16 1/2" (419 mm)	min. 32 1/4" (820 mm)	max. 19" (483 mm)
 LeMans 50	min. 18 3/8" (467 mm)	min. 36 1/4" (920 mm)	max. 21 1/4" (540 mm)
 LeMans 60	min. 22 1/4" (565 mm)	min. 38" (965 mm)	max. 25" (635 mm)

Frameless cabinets
With center stile



	A	B
 LeMans 45	min. 16 1/2" (419 mm)	min. 32 1/4" (820 mm)
 LeMans 50	min. 18 3/8" (467 mm)	min. 36 1/4" (920 mm)
 LeMans 60	min. 22 1/4" (565 mm)	min. 38" (965 mm)

Frameless cabinets
Without center stile