

B600/700/800 Series

The B600/700/800 Series are Schlage's highest grade deadbolt locks. Choose the 600 for Grade 1 security in high-traffic commercial applications. Choose the 700 or 800 and get standard a Primus XP controlled access cylinder (700) or Primus® XP high security cylinder with UL 437 rating (800). A variety of functions and finishes makes the B600/700/800 Series a versatile choice for added security no matter where you use it.

Pictured here: B600 (Grade 1) deadbolt with D Series Orbit knob shown in 626 satin chrome



ELECTRICAL

The toughest deadbolts in the business

- 1" (25 mm) throw, high-strength steel alloy deadbolt with hardened steel roller resists sawing and kick-in attacks
- Precision-built solid brass 6-pin cylinders with phosphor bronze springs and nickel silver pins ensure long life and smooth operation
- Tough nickel silver keys for smooth, long-lasting operation
- Exclusive concealed wood frame reinforcer protects wood jamb against kick-in attacks
- Free-spinning solid cylinder collar resists wrenching and prying
- Large inside thumbturn makes it easy to throw and retract deadbolt
- Metal shield protects bolt from ice-pick attack through the door
- Hardened steel ball-bearings protect mounting bolts from drill attack

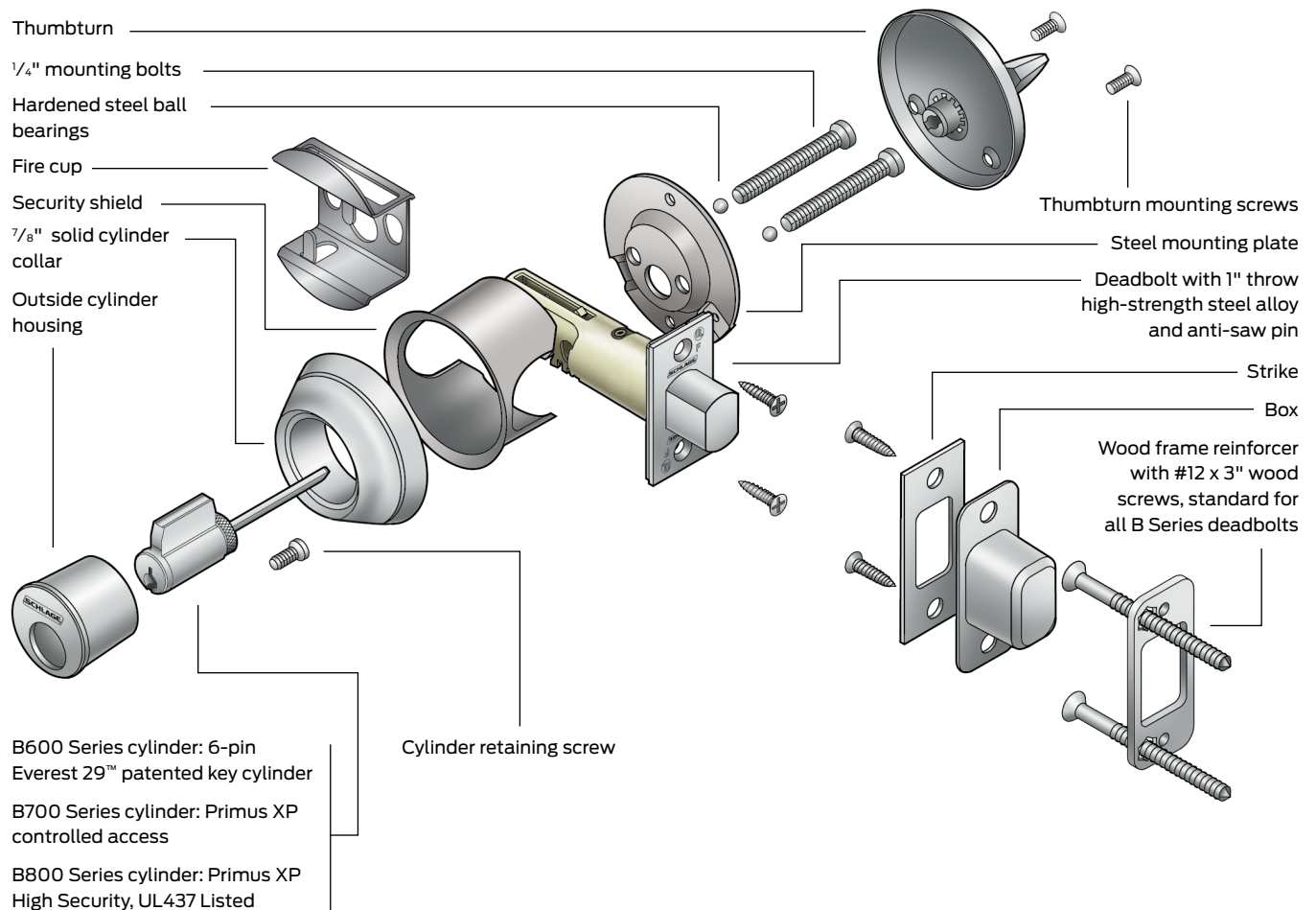

Deadbolt designs

B600 Series

Schlage's toughest heavy duty Grade 1 commercial deadbolt.

Furnished with conventional cylinder standard.

Also available with full size interchangeable core cylinder or small format interchangeable core (SFIC) cylinder.

Requires 2 1/8" (54mm) prep. UL10B listing standard for auxiliary lock on A label fire doors.



B700 Series

Same lock as B600 Series but furnished with Primus XP controlled access cylinder for patented key control, geographical exclusivity and resistance to picking and impressioning. Also available with Primus XP full size interchangeable core cylinder.







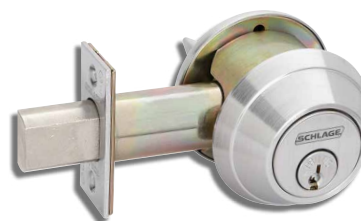





B800 Series

Same lock as B700 Series but Primus XP high security cylinder is UL437 listed to resist drilling and other forms of physical attack. Not available in interchangeable core.



All designs shown in 626 satin chrome

Deadbolt finishes





										
	605 Bright brass	606 Satin brass	609 Antique brass	612 Satin bronze	613 Oil rubbed bronze	619 Satin nickel	625 Bright chromium plated	626 Satin chromium plated	626AM Antimicrobial coating	643e Aged bronze
B600/700/800										
B600	•	•	•	•	•	•	•	•	•	•
B700	•	•	•	•	•	•	•	•	•	•
B800	•	•	•	•	•	•	•	•	•	•

e = an equivalent finish to the BHMA standard.

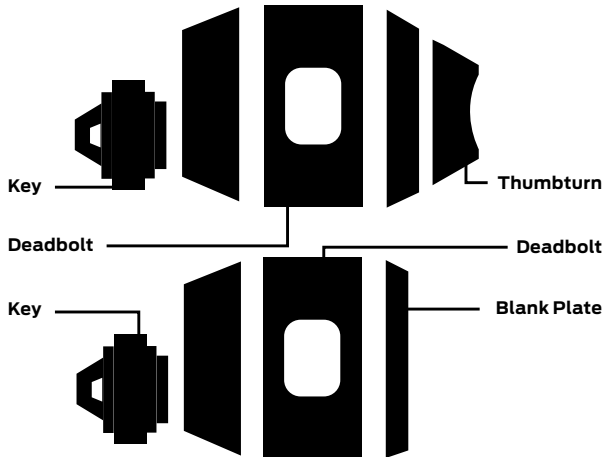
Deadbolt functions

ANSI A156.5 bored deadbolt locks grade 1



-  Standard cylinder.
-  FSIC - full size interchangeable core option.
-  SFIC - small format interchangeable core option.
-  Complies with ADA accessibility guidelines.

***Caution:**

Double cylinder locks on any door are a life safety hazard in times of emergency and their use is not recommended. Installation should be in accordance with existing codes only.

ADA compliant:

Schlage Lock Company offers a wide selection of locks designed to meet the Americans with Disabilities Act.

Product information and specifications contained in this catalog are subject to change without notice. Please consult the factory.

B600 Series

Schlage ANSI
B660P E0151

Single cylinder deadbolt

- Deadbolt thrown or retracted by key outside or thumbturn inside.

Outside Inside



Schlage ANSI
B661P E0161

One-way deadbolt

- Deadbolt thrown or retracted by key outside.
- Blank plate with exposed screws inside.

Outside Inside



B700 Series

Schlage ANSI
B760P E0151

Single cylinder deadbolt

- Deadbolt thrown or retracted by key outside or thumbturn inside.

Outside Inside



Schlage ANSI
B761P E0161

One-way deadbolt

- Deadbolt thrown or retracted by key outside.
- Blank plate with exposed screws inside.

Outside Inside



B800 Series

Schlage ANSI
B860P E0151

Single cylinder deadbolt

- Deadbolt thrown or retracted by key outside or thumbturn inside.

Outside Inside



Schlage ANSI
B861P E0161

One-way deadbolt

- Deadbolt thrown or retracted by key outside.
- Blank plate with exposed screws inside.

Outside Inside



Schlage ANSI
B662P* **E0141**
Double cylinder deadbolt

- Deadbolt thrown or retracted by key on either side.

Outside Inside



Schlage ANSI
B663P **E0171**
Classroom deadbolt

- Deadbolt thrown only by key outside.
- Deadbolt retracted by key outside or thumbturn inside.

Outside Inside



Schlage ANSI
B664P **E0101**
Cylinder only deadbolt

- Deadbolt thrown or retracted by key one side.
- No trim on inside.

Outside Inside



Schlage ANSI
B680 **E0191**
Door bolt

- Deadbolt thrown or retracted by thumbturn inside.
- No outside trim.

Outside Inside



Schlage ANSI
B762P* **E0141**
Double cylinder deadbolt

- Deadbolt thrown or retracted by key on either side.

Outside Inside



Schlage ANSI
B763P **E0171**
Classroom deadbolt

- Deadbolt thrown only by key outside.
- Deadbolt retracted by key outside or thumbturn inside.

Outside Inside



Schlage ANSI
B764P **E0101**
Cylinder only deadbolt

- Deadbolt thrown or retracted by key one side.
- No trim on inside.

Outside Inside



Schlage ANSI
B862P* **E0141**
Double cylinder deadbolt

- Deadbolt thrown or retracted by key on either side.

Outside Inside



Schlage ANSI
B863P **E0171**
Classroom deadbolt

- Deadbolt thrown only by key outside.
- Deadbolt retracted by key outside or thumbturn inside.

Outside Inside



Schlage ANSI
B864P **E0101**
Cylinder only deadbolt

- Deadbolt thrown or retracted by key one side.
- No trim on inside.

Outside Inside

